



Product Catalogue 2018/2019

South East Europe

SECTIONS

Portable Gas Detection 01	Personal Protection Equipment 02	Drug & Alcohol Detection 03
Masks & Filters 04	Fire & Gas Detection Systems 05	Engineered Solutions 06
Service, Training & Rental 07	Diving Technology 08	

WELCOME

Dräger is a leading international company in the fields of medical and safety technology. Founded in Lübeck in 1889, Dräger has grown into a worldwide enterprise in its fifth generation as a family-run business. Our long-term success is predicated on a value-oriented corporate culture with four central strengths: close collaboration with our customers, the expertise of our employees, continuous innovation and outstanding quality.

"Technology for Life" is our guiding principle. Wherever they are deployed – in clinical settings, industry, mining or emergency services – Dräger products protect, support and save lives.

This document is proprietary information and protected under the Copyright Act

Whilst every care has been taken in the compilation of this price list, and every attempt made to present up-to-date and accurate information, we cannot guarantee that inaccuracies will not occur. Dräger Region South East Europe reserves the right to make any changes without providing prior notification.

PORTABLE GAS DETECTION

**X-AM 2500/5000 FAMILY**

X-am 2500
 X-am 3500
 X-am 5000
 X-am 5600
 X-am 8000
 X-Zone 5500

PAC FAMILY

Pac 6000 / 6500
 Pac 8000 / 8500

X-AM 5100/7000

X-am 5100
 X-am 7000

ACCESSORIES

Sampling
 Software
 Calibration Adaptors
 X-Dock
 Automatic Bump Test Stations
 Regulators & Accessories

PORTABLE INSTRUMENTS FOR EMISSION CONTROL

X-pid 9000/9500
 FG7000
 P4000
 GS2
 Multi-PID2

PUMPS & ACCESSORIES FOR DRÄGER TUBES

X-act 5000
 Accuro Pump
 Accessories

DRÄGER TUBES

Short Term Monitoring Tubes
 Long Term Monitoring - Diffusion Tubes
 Sampling Tubes for Passive Monitoring
 Long Term Monitoring
 Gas Detection Kit
 Air Current Detection Kit
 Air Flow Check
 DLE Kit
 Aerotest Range

Place You Put Your Faith

PORTABLE GAS DETECTION

PRODUCT	DESCRIPTION	PART NO	CATEGORY
---------	-------------	---------	----------

X-AM 2500



3 Years Warranty on instrument &
Ex, O2, CO & H2S Sensors

The Dräger X-am 2500 is a small lightweight 1 to 4 Gas Detection Instrument, which is specially designed for the requirements for personal monitoring. Comes standard with data logger It can be equipped with one catalytic Ex-sensor and three electrochemical sensors at maximum. These guarantee reliable monitoring of the ambient air to explosive gases and vapours as well as O2 and toxic gases like CO, H2S, SO2 and NO2. In order to accommodate a wide range of customer requirements the Dräger X-am 2500 Flex is assembled immediately before delivery according to the customer's specifications. Furthermore the X-am 2500 is available in 5 different variations.

X-am 2500 Standard Variations (Non-Flex)	These instruments are fixed to the number and the combination of sensors that they are sold with.		
Dräger X-am 2500 4 gas (bundle)	Instrument with exchangeable sensors but not expandable. X-AM 2500 EX, O2, CO LC, H2S LC (83 23 918) incl. Power & Charging set (8318785)	8323919	
X-am 2500 Ex, O2, CO-LC	Add Battery and Power supply	8323916	D
X-am 2500 Ex, O2, H2S-LC	Add Battery and Power supply	8323914	D
X-am 2500 Ex, O2	Add Battery and Power supply	8323912	D
X-am 2500 Ex	Add Battery and Power supply	8323910	D
X-am 2500 Basic	Instrument without sensors and power supply, incl. manufacturer certificate	8323920	D
X-am 2500 Flex Option	The Flex option allows for sensors to be added or removed as required by the customer. SO2 ,NO2 and Cat-Ex Mining 125 PR - Gas are only possible with Flex option		
X-am 2500 Flex Basic Unit	Add Sensors, Battery and Power supply	8323900	D
Sensors for use with X-am 2500 Flex version			
Following sensors are available:			
Cat-Ex 125 PR 0-100% LEL		6812950	D
or			
Cat-Ex 125 PR-Gas 0-100% LEL		6813080	D
and up to three EC sensors from below list	(Please note: Only one sensor from NO2 and SO2 can be used in one instrument)		
XXS O2		6810881	D
XXS CO-LC		6813210	D
XXS H2S LC		6811525	D
XXS NO2		6810884	D
XXS SO2	Consider adding H2S filter (6811344) for this sensor	6810885	D

PORTABLE GAS DETECTION

PRODUCT	DESCRIPTION	PART NO	CATEGORY
X-am 2500 Power Supply Options			
Additional Power Supplies - Power pack & charging set			
	Consisting of: NiMH-power pack T4, charging module, single charger (worldwide) for 1 charging module Power pack & charging set HC**	8318785	D
	Consisting of: NiMH-power pack HC T4, charging module, single charger (worldwide) for 1 charging module Charging Set Basic	8322785	D
	Consisting of: charging module, single charger (worldwide) for 1 charging module	8320333	D
* for Dräger X-am 5000 instruments until serial number AREH-0410			
** for Dräger X-am 5000 instruments starting with serial number AREH-0411			
X-am 2500 Battery only Options			
NiMH T4 Battery only		8318704	D
Alkaline Battery Holder T3/T4 (without batteries)	Add 2 x AA Batteries	8322237	D
Alkaline batteries T3 (2 pcs.)	for battery holder ABT 0100	8322239	D
Alkaline batteries T4 (2 pcs.)	for battery holder ABT 0100	8322240	D
X-am 2500 Charger Options			
	Module & Single charger only	8320333	D
<i>Place You Put Your Faith</i>			
Charging Set Basic			
Charging Module only	Module only - For Xam 1/2/5	8318639	D
Battery Charging Adapter	To charge a battery (8318704 & 8322244) w/o instrument. Charging module 8318639 will be needed to use this adapter	8326101	D
Power Supply - 5 Amp output	For up to 20 modules	8315805	D
Single charger - 2.5 Amp output	For up to 5 modules	8316994	D
Single charger - 1.25 Amp output	For up to 2 modules	8315635	D
Car Charging Connector	12V or 24V supply	4530057	D
	(Charging module not Included)	8318779	D
Vehicle charger mounting kit (For one charging module)			
Additional strap for vehicle charger mounting kit		8318788	D

PORTABLE GAS DETECTION

PRODUCT	DESCRIPTION	PART NO	CATEGORY
X-am 2500 Accessories			
Protection			
Screen protector X-am 1/2/5000 (Packet of 10)		8320040	D
Leather Carry Case	Protects the display screen from scratches.	8318755	D
Rubber boot		8321506	D
Case (without content)	Space for: power supply, probe, Calibration gas cylinder, ext. pump, 3 m Viton hose	8320467	D
Sampling			
 Hand Pump		6801933	D
 Hand pump adapter		8319195	D
 Dräger X-am pump	X-am pump (8327101) with USB cable (8327108)	8327100	D
 Dräger X-am pump with USB cable, charger, shoulder strap	Includes: X-am pump (8327101), USB cable (8327108), USB charger (8327102) , Shoulder strap (8319386)	8327115	D
 Case for Dräger X-am pump	This contains: Carrying case (8327114) , Shoulder strap (8319386) and has room for storing the power cord, charging unit, and hose.	8327104	D
 CSE set X-am pump	The CSE Set X-am Pump contains X-am pump(8327101), Shoulder strap (8319386), 5m FKM hose with adapters (8325705), USB cable (8327108), float probe (8327654) & Case (8327114)	8327105	D
 Leather case for X-am pump	Protects X-am instrument and pump. Belt-loop on back side. X-am instrument can be removed separately from pump	8327103	D
USB 10x Multi-Charger	For charging 10 x X-am pumps	8327113	D
 Filter with hose connector (3mm and 5mm)	removed separately from pump.	8319364	D
 5 m FKM hose (diameter 3 mm)	Solvent-resistant. 3mm diameter speeds up flushing time	8325705	D

PORTABLE GAS DETECTION

PRODUCT	DESCRIPTION	PART NO	CATEGORY
---------	-------------	---------	----------

X-AM 3500

***NEW*** Dräger X-am 3500®

The Dräger X-am® 3500 was especially designed for clearance measurements. The 1 to 4 gas detector reliably detects flammable gases and vapours as well as O₂, CO, H₂S, NO₂ or SO₂. The innovative signalling design and extensive range of accessories ensure optimum safety and easy handling.

Delivery content:

Internal Pump with pump adapter
 Rechargeable Lithium Ion Battery
 Crocodile Clip
 Instruction for use (de, en, fr, es, pt, it, nl, ru, zh, ja)
 Event- and data logger
 Manufacturer Certificate & Calibration Certificate

Dräger X-am 3500

Instrument with exchangeable sensors but not expandable.

Standard calibration of the Ex-sensor:

Methane 0-100 % LEL;

Incl. default (Germany) sensor settings

Dräger X-am 3500 Ex, O ₂		8328412
Dräger X-am 3500 Ex, O ₂ , H ₂ S LC		8328414
Dräger X-am 3500 Ex, O ₂ , CO LC		8328416
Dräger X-am 3500 Ex, O ₂ , CO LC, H ₂ S LC		8328418
Bundle Dräger X-am 3500 4 Gas incl. charging equipment	Dräger X-am 3500 Ex, O ₂ , CO LC, H ₂ S LC 8328418 incl. inductive power unit 8325825 and power supply 8316997	8328419
Dräger X-am 3500 Ex, O ₂ , CO LC, NO ₂		8328422
Dräger X-am 3500 Ex, O ₂ , H ₂ S LC, SO ₂		8328424
Dräger X-am 3500 Basic with Pump	Incl. Li Ion battery and pump, w/o sensors	8328420
Instruction for Use (Language 2)	(bg; cs; da; el; fi; hr; hu; ko; no; pl; ro; sk; sl; sv; tr)	9033668
Sensors		
DrägerSensor CatEx 125 PR*		6812950
DrägerSensor XXS O ₂ *		6810881

PORTABLE GAS DETECTION

PRODUCT	DESCRIPTION	PART NO	CATEGORY
DrägerSensor XXS CO-LC*		6813210	
DrägerSensor XXS H2S LC*		6811525	
DrägerSensor XXS NO2		6810884	
DrägerSensor XXS SO2		6810885	
Charging Accessories			
Inductive power unit	(charging 1 device)	8325825	
Power supply (worldwide)	(1 device)	8316997	
Power supply (worldwide)	(up to 5 devices)	8316994	
Power supply* (worldwide)	(up to 5 devices) *Adapter 83 25 736 necessary	8321849	
Power supply* (worldwide)	(up to 20 devices*)	8321850	
Head Adapter for connection to power supplies	83 21 850 (20) or 83 21 849 (5) or 83 21 855 (5)	8325736	
Bundle Car mounting unit	incl. Car adapter 12V/24V and Head adapter (83 21 855, 83 27 636, 83 25 736)	8328283	
Car adapter* 12V/24V	(up to 5 devices) *Adapter 83 25 736 necessary	8321855	
Car mounting unit	(for 1 Inductive power unit)	8327636	
Pump Accessories			
Pump adapter	(delivery content with pump)	8326820	
Dust – and water filter	(delivery content with pump)	8319364	
5 m FKM hose	ID 3,2 mm with adapter	8325705	
10 m FKM hose	ID 3,2 mm with adapter	8325706	
20 m FKM hose	ID 3,2 mm with adapter	8325707	
Float probe black EPP, incl. 3 m FKM hose	ID 3,2 mm	8325831	
Float probe black EPP, incl. 10 m FKM hose	ID 3,2 mm	8325832	
Float probe transparent with luer adapter		8327654	
Telescopic probe ES 150		8316533	
For further probes please have a look at the multiple use Accessories price list			
Calibration Accessories			
Calibration adapter		8326821	
Dräger X-dock Modul X-am 3500/8000		8321893	
Dräger X-dock Modul X-am 3500/8000+ (charged)		8321894	
Nonane checker X-am 3500/8000		8325861	

PORTABLE GAS DETECTION

PRODUCT	DESCRIPTION	PART NO	CATEGORY
Communication Accessories			
Dräger GasVision7 Licence key	Dräger CC-Vision Basic Free of charge available at the Internet www.draeger.com	8325646	
USB DIRA with USB cable	for Dräger-X-am 1/2x/5x00, 3500 Dräger X-am 7000, X-am 8000 and Dräger Interlock;	8317409	
DIRA Holder X-am 3500/8000		8325859	
Accessories			
For further accessories please look at X-am 8000 accessories.			
Spare parts			
Li-Ion battery incl. back cover		8326817	
Front cover incl. membranes		8328604	



Place You Put Your Faith

PORTABLE GAS DETECTION

PRODUCT	DESCRIPTION	PART NO	CATEGORY
---------	-------------	---------	----------

X-AM 5000

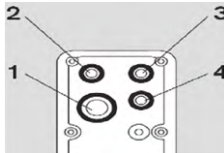

X-am 5000 is a five gas instrument with four sensor slots, to make this unit a 5 gas instrument you must use a dual sensor. Sensors and a battery are not included with the instrument. Comes standard with data logger and features a pixelated display.

1. Cat Ex 2 & 3. XXS Sensor slots 4. Dual XXS or normal XXS Sensor slot

The X-am 5000 has a 3 year warranty, sensor warranties are varied

Dräger X-am 5000 (Construction KIT)	Unlimited 1 - 5 instrument with exchangeable sensors. At least one sensor or power pack must be chosen. With selectable special calibrations and settings. Standard calibration of the Ex-sensor: Methane. Incl. adjustable alarm levels to country specific standards	8320000	D
X-am 5000 Standard Units	Calibration interval 6 monthly		
Dräger X-am 5000 (Add sensors)	Sensors, Battery & Power supply not Included	8320088	D
Additional Power Supplies	Power pack & charging set Consisting of: NiMH-power pack T4, charging module, single charger (worldwide) for 1 charging module Power pack & charging set HC**	8318785	
Sensors for use with X-am 5000- Refer page for more info			
Cat -Ex sensor for Sensor slot 1:			
▶ Cat Ex 125 Poison Resistant	3 Year warranty	6812950	D
or			
Cat Ex 125 PR Gas	2 Year warranty	6813080	D
Electrochemical sensors for slot 2,3 &4 (Up to 3 from below list)			
XXS Amine	1 Year warranty	6812545	D
▶ XXS CO	3 Year warranty	6810882	D
▶ XXS CO LC (Use as default)	2 Year warranty	6813210	D
XXS CO HC	1 Year warranty	6812010	D
XXS CO-H2 CP (Can only be used on slot 4)	1 Year warranty	6811950	D
▶ XXS CO / H2S (Can only be used on slot 4)	2 Year warranty	6811410	D
▶ XXS H2S-LC/ CO-LC (use as default) (Can only be used on slot 4)	2 Year warranty	6813280	D
▶ XXS O2 / CO-LC (Can only be used on slot 4)	2 Year warranty	6813275	D









PORTABLE GAS DETECTION

PRODUCT	DESCRIPTION	PART NO	CATEGORY
XXS COCl2 - Phosgene	6 Month Warranty	6812005	D
XXS H2S	3 Year warranty	6810883	D
▶ XXS H2S Low Concentrations	3 Year warranty	6811525	D
XXS H2S HC	1 Year warranty	6812015	D
XXS H2	1 Year warranty	6812370	D
XXS H2 HC	1 Year warranty	6812025	D
▶ XXS O2	3 Year warranty	6810881	D
XXS O2 100 (Can only be used on slot 4)	1 Year warranty	6812385	D
XXS CL2	1 Year warranty	6810890	D
XXS CO2	1 Year warranty	6810889	D
XXS HCN	1 Year warranty	6810887	D
XXS HCN PC	1 Year warranty	6813165	D
XXS NH3	1 Year warranty	6810888	D
XXS NO2	1 Year warranty	6810884	D
▶ XXS NO2 LC use as NO2 default	1 Year warranty	6812600	D
XXS NO	1 Year warranty	6811545	D
XXS Ozone	1 Year warranty	6811540	D
XXS Odorant	1 Year warranty	6812535	D
XXS PH3	1 Year warranty	6810886	D
XXS PH3 HC	1 Year warranty	6812020	D
XXS SO2 (Consider using H2S filter)	1 Year warranty	6810885	D
XXS OV	1 Year warranty	6811530	D
XXS OV-A	1 Year warranty	6811535	D
X-am 5000 Power Supply Options			
X-am 5000 Battery + Charger Options			
NiMH Charging Set (Standard)	NiMH battery & charger with power supply	8318785	D
X-am 5000 Battery only Options			
NiMH T4 Battery only		8318704	D
HC NiMH T4 Battery only		8322244	D
Alkaline Battery Holder T3/T4 (without batteries)	Add 2 x AA Batteries	8322237	D



PORTABLE GAS DETECTION

PRODUCT	DESCRIPTION	PART NO	CATEGORY
X-am 5000 Charger Options			
	Module & Single charger only	8320333	D
Charging Set Basic			
Charging Module only	Module only - For Xam 1/2/5	8318639	D
Battery Charging Adapter	To charge a battery (8318704 & 8322244) w/o instrument. Charging module 8318639 will be needed to use this adapter	8326101	D
Power Supply - 5 Amp output	For up to 20 modules	8315805	D
Single charger - 2.5 Amp output	For up to 5 modules	8316994	D
Single charger - 1.25 Amp output	For up to 2 modules	8315635	D
Car Charging Connector	12V or 24V supply	4530057	D
Spare Power Packs X-am 5000	*For instruments until serial number AREH-0410 Battery holder* ABT 0000 (w/o Alkaline-batteries)	8318703	D
	Alkaline batteries T4* (2 pcs.) for battery holder ABT 0000 8318 703	8318708	D
	(Charging module not included)	8318779	D
Vehicle charger mounting kit (For one charging module)			
Additional strap for vehicle charger mounting kit		8318788	D
X-am 5000 Accessories			
Protection			
Screen protector X-am 1/2/5000 (Packet of 10)		8320040	D
Leather Carry Case	Protects the display screen from scratches.	8318755	D
Rubber boot		8321506	D
Case (without content)	Space for: power supply, probe, Calibration gas cylinder, ext. pump, 3 m Viton hose	8320467	D
Sampling			
		6801933	D
Hand Pump			

PORTABLE GAS DETECTION

PRODUCT	DESCRIPTION	PART NO	CATEGORY
 Hand pump adapter		8319195	D
 Dräger X-am pump	X-am pump (8327101) with USB cable (8327108)	8327100	D
 Dräger X-am pump with USB cable, charger, shoulder strap	Includes: X-am pump (8327101), USB cable (8327108), USB charger (8327102) , Shoulder strap (8319386)	8327115	D
 Case for Dräger X-am pump	This contains: Carrying case (8327114) , Shoulder strap (8319386) and has room for storing the power cord, charging unit, and hose.	8327104	D
 CSE set X-am pump	The CSE Set X-am Pump contains X-am pump(8327101), Shoulder strap (8319386), 5m FKM hose with adapters (8325705), USB cable (8327108), float probe (8327654) & Case (8327114)	8327105	D
 Leather case for X-am pump	Protects X-am instrument and pump. Belt-loop on back side. X-am instrument can be removed separately from pump	8327103	D
USB 10x Multi-Charger	For charging 10 x X-am pumps	8327113	D
 Filter with hose connector (3mm and 5mm)	removed separately from pump.	8319364	D
 5 m FKM hose (diameter 3 mm)	Solvent-resistant. 3mm diameter speeds up flushing time	8325705	D

PORTABLE GAS DETECTION

PRODUCT	DESCRIPTION	PART NO	CATEGORY
Bump Testing and Calibration			
X-dock	See X-dock Price pages		
	Add Gas Cylinder	8319131	D
Dräger Bump Test Station Dräger X-am 1/2/5000			
	Also hold DIRA interface	8318752	D
Calibration cradle Dräger X-am 1/2/5000			
Standard regulator 0.5 l/min	nickel plated brass, 5/8"-18 UNF	6810397	D
Stainless Steel Regulator 0.5 L/min	Good for CL2 or NH3	6813104	D
Trigger regulator 0.5 l/min,	nickel plated brass, 5/8"-18 UNF	6810649	D
Software and Communication			
USB DIRA with USB cable	Use with X-am 1/2/5, X-am 7000, X-am 8000	8317409	D
CC-Vision Basic (Free download from www.draeger.com/software)	Required for setup. Can download data logger		D
GasVision 7 license key (Software download from www.draeger.com/software)	Reports and Trends from Data loggers. License key is supplied. Software must be downloaded from the Dräger website	8325646	D

PORTABLE GAS DETECTION

PRODUCT	DESCRIPTION	PART NO	CATEGORY
---------	-------------	---------	----------

X-AM 5600

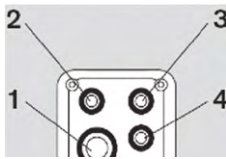

X-am 5600 is a six gas instrument with four sensor slots. To make this unit a 6 gas instrument you must use two dual sensors. Sensors and a battery are not included with the instrument. Comes standard with data logger and features a pixelated display

1. Single or dual IR-sensor 2 & 3. XXS Sensor slots 4. Dual XXS or normal XXS Sensor slot



The X-am 5600 has a 3 year warranty, sensor warranties are varied

X-am 5600 Standard Units	Calibration interval 6 monthly		
Dräger X-am 5600	Sensors & Battery not Included	8321373	D
Dräger X-am 5600 (Construction kit)	Unlimited 1- 6 instrument with exchangeable Sensors. At least one sensor or power pack must be chosen. Standard calibration of the Ex-sensor: Methane. incl. adjustable alarm levels to country specific standards	8321050	D
Sensors for use with X-am 5600- Refer Sensor page for more info			
Infrared (IR) sensor for Sensor slot 1:			
▶ Dual IR Ex/CO2	5 Year warranty	6811960	D
or			
▶ IR Ex	5 Year warranty	6812180	D
or			
▶ IR CO2	5 Year warranty	6812190	D
Electrochemical sensors for slot 2,3 &4 (Up to 3 from below list)			
XXS Amine	1 Year warranty	6812545	D
▶ XXS CO	3 Year warranty	6810882	D
▶ XXS CO LC (Use as default)	2 Year warranty	6813210	D

PORTABLE GAS DETECTION

PRODUCT	DESCRIPTION	PART NO	CATEGORY
XXS CO HC	1 Year warranty	6812010	D
XXS CO-H2 CP (Can only be used on slot 4)	1 Year warranty	6811950	D
▶ XXS CO / H2S (Can only be used on slot 4)	2 Year warranty	6811410	D
XXS H2S-LC/ CO-LC (use as default) (Can only be used on slot 4)	2 Year warranty	6813280	D
XXS O2 / CO-LC (Can only be used on slot 4)	2 Year warranty	6813275	D
XXS COCl2 - Phosgene	6 Month Warranty	6812005	D
XXS H2S	3 Year warranty	6810883	D
▶ XXS H2S Low Concentrations	3 Year warranty	6811525	D
XXS H2S HC	1 Year warranty	6812015	D
XXS H2	1 Year warranty	6812370	D
XXS H2 HC	1 Year warranty	6812025	D
▶ XXS O2	3 Year warranty	6810881	D
XXS O2 100 (Can only be used on slot 4)	1 Year warranty	6812385	D
XXS CL2	1 Year warranty	6810890	D
XXS CO2	1 Year warranty	6810889	D
XXS HCN	1 Year warranty	6810887	D
XXS HCN PC	1 Year warranty	6813165	D
XXS NH3	1 Year warranty	6810888	D
XXS NO2	1 Year warranty	6810884	D
▶ XXS NO2 LC use as NO2 default	1 Year warranty	6812600	D
XXS NO	1 Year warranty	6811545	D
XXS Ozone	1 Year warranty	6811540	D
XXS Odorant	1 Year warranty	6812535	D
XXS PH3	1 Year warranty	6810886	D
XXS PH3 HC	1 Year warranty	6812020	D
XXS SO2 (Consider using H2S filter)	1 Year warranty	6810885	D
XXS OV	1 Year warranty	6811530	D
XXS OV-A	1 Year warranty	6811535	D
X-am 5600 Power Supply Options			
X-am 5600 Battery + Charger Options			
NiMH Charging Set (Standard)	NiMH battery & charger with power supply	8318785	D
X-am 5600 Battery Only Options			
NiMH T4 Battery only		8318704	D
HC NiMH T4 Battery only		8322244	D
Alkaline Battery Holder T3/T4 (without batteries)	Add 2 x AA Batteries	8322237	D

PORTABLE GAS DETECTION

PRODUCT	DESCRIPTION	PART NO	CATEGORY
X-am 5600 Charger Options			
	Module & Single charger only	8320333	D
Charging Set Basic			
Charging Module only	Module only - For Xam 1/2/5	8318639	D
Battery Charging Adapter	To charge a battery (8318704 & 8322244) w/o instrument. Charging module 8318639 will be needed to use this adapter	8326101	D
Power Supply - 5 Amp output	For up to 20 modules	8315805	D
Single charger - 2.5 Amp output	For up to 5 modules	8316994	D
Single charger - 1.25 Amp output	For up to 2 modules	8315635	D
Car Charging Connector	12V or 24V supply	4530057	D
	(Charging module not included)	8318779	D
Vehicle charger mounting kit (For one charging module)			
Additional strap for vehicle charger mounting kit		8318788	D
X-am 5600 Accessories			
Protection			
Screen protector X-am 1/2/5000 (Packet of 10)		8320040	D
Rubber boot		8321506	D
Case (without content)	Space for: power supply, probe, Calibration gas cylinder, ext. pump, 3 m Viton hose	8320467	D
Sampling			
		6801933	D
Hand Pump			

PORTABLE GAS DETECTION

PRODUCT	DESCRIPTION	PART NO	CATEGORY
---------	-------------	---------	----------

X-AM 8000



The Dräger X-am 8000 is a smart and lightweight 1-7 Gas Detection Instrument, which is specially designed for the requirements of clearance measurements for confined space entry and leak search. It can be equipped with an internal pump. Furthermore a broad combination of infrared sensor, catalytic, PID and electrochemical sensors are possible. A simultaneous measurement of up to 7 gases guarantees a reliable monitoring of the ambient air to explosive gases and organic vapours as well as O₂ and other toxic gases. In order to accommodate a wide range of customer requirements each Dräger X-am 8000 is assembled immediately before delivery according to the customer specifications

("Assemble to Order").

An order for a complete instrument consists of:

- Instrument Incl. power pack, shoulder strap
- opt. charging accessory
- opt. pump Incl. adapter
- opt. sensors IR / CAT / PID / EC
- opt. special calibrations
- opt. customer configuration
- Incl. manufacturer and calibration certificate

X-am 8000 (Construction kit - Order entered as a configurator) - At least one sensor must be chosen.

Complete configuration to be supplied to customer service. Country specific (AU or NZ) settings will be selected by default. For special conditions, please select the basic instrument and add sensors as required.

Place You Put Your Faith

Enclosed in instrument: Adjustable alarm levels, Rechargeable Lithium Ion battery, Inductive charging unit, Power supply, shoulder strap, Instruction for use, Event and data logger, Manufacturer certificate & Calibration certificate
Optional: Internal pump with pump adapter, Crocodile clip, RFID chip, Bluetooth

8325800

H

X-am 8000 Basic instrument (Diffusion version)

Includes: X-am 8000, Li-Ion battery, shoulder strap, manufacturer certificate.
Not Included: Pump, sensors, inductive power unit, power supply

8325865

H

X-am 8000 Basic instrument (Pump version)

Includes: X-am 8000, Li-Ion battery, pump, pump adapter, shoulder strap, manufacturer certificate.
Not Included: Sensors, inductive power unit, power supply

8325875

H

Sensors for use with X-am 8000- Refer Sensor page for more info

Draeger sensor PID LC ppb

1-5 Sensors selectable

6813500

H

Draeger sensor PID HC

Max 7 gases

6813475

H

For additional sensors please have a look at the sensor price list.

PORTABLE GAS DETECTION

PRODUCT	DESCRIPTION	PART NO	CATEGORY
X-am 8000 Charging Accessories			
Inductive power unit	Module for charging 1 device	8325825	H
Power supply (worldwide)	For up to 2 devices	8315635	D
Power supply (worldwide)	For up to 5 devices	8316994	D
Car adapter 12V/24V	For up to 5 devices	4530057	D
Car mounting unit	for 1 Inductive power unit	8327636	H
X-am 8000 Accessories			
Rubber boot, removable		8325858	H
Leather bag (device)		8327664	H
Dräger X-am 8000 case, plastic, black	w/o content	8327661	H
Dräger X-am 8000 case with PID accessories & tubes and ES 150 probe	Case with PID accessories & probe. add instrument	8327845	H
Leather bag set PID 8327664 & 8327663		8327639	H
Display protection foil (3 pcs)		8326828	H
Shoulder strap, complete	Comes with the device	8326823	H
Side carrying strap (extractable)		8323032	H
Label holder for shoulder strap	Comes with the device	8326824	H
Label for holder, silver (5 pcs)		8327645	H
Base, to raise the device for Area monitoring		8325874	H
RFID transponder reader		6559283	H
X-am 8000 PID Accessories			
Pre tube holder	Attaches to the pump adapter	6813769	H
Pre tube Benzene (10 pcs.)		8103511	C
Pre tube humidity (10 pcs.)		8103531	C
Pre tube carbon (10 pcs.)		CH24101	C
Tube opener TO 7000		6401200	D
PID lamp cleaning set		8319111	H
Bag for PID Accessories & tubes		8327663	H
X-am 8000 Pump Accessories			
Pump adapter (delivery content with pump)		8326820	H
Dust – and water filter (delivery content with pump)		8319364	D
5 m FKM hose ID 3,2 mm with adapter		8325705	D
10 m FKM hose ID 3,2 mm with adapter		8325706	D

PORTABLE GAS DETECTION

PRODUCT	DESCRIPTION	PART NO	CATEGORY
Float probe black EPP, Incl. 3 m FKM hose ID 3,2 mm		8325831	D
Float probe black EPP, Incl. 10 m FKM hose ID 3,2 mm		8325832	D
Float probe transparent with luer adapter		8327654	D
Telescopic probe ES 150		8316533	D
X-am 8000 Calibration accessories			
Calibration adapter		8326821	H
Dräger X-dock Module X-am 8000	Please see X-dock pages	8321893	H
Dräger X-dock Module X-am 8000+ (charging option)	Please see X-dock pages	8321894	H
Nonane checker X-am 8000		8325861	H
X-am 8000 communication accessories			
Dräger GasVision7 Licence key	Reports and Trends from Data loggers. License key is supplied. Software must be downloaded from the Dräger website	8325646	D
CC-Vision Basic (Free download from www.draeger.com/software)	Required for setup. Can download data logger		
USB DIRA with USB cable	Use with X-am 1/2/5, X-am 7000, X-am 8000	8317409	D
DIRA Holder X-am 8000		8325859	H

Place You Put Your Faith

PORTABLE GAS DETECTION

PRODUCT	DESCRIPTION	PART NO	CATEGORY
---------	-------------	---------	----------

X-ZONE 5500



State-of-the-art area monitoring – the Dräger X-zone 5500, in combination with the X-am 5000, 5100 or X-am 5600 gas detection instruments, can be used for the measurement of up to 6 gases.

Up to 25 units linked wirelessly each with an alarm of up to 110 dB. The Dräger X-zone 5500 provides a modbus output as well for integration to the control room system.

Via the potential-free alarm contact, the Dräger X-zone 5500 device can also be interconnected and operate with external equipment.

A personal gas detection instrument like a Dräger X-am 5000, 5100 or 5600 is necessary to initiate the Dräger X-zone 5500.

X-Zone 5500	Includes 120 hr. battery - needs charger	8324823	D
X-Zone 5500 with Pump	Includes 120 hr. battery - needs charger	8324825	D
X-Zone 5500 with pump -X-am 5000 Kit - 4 gas	Includes 120hr battery, Charger, X-am 5000 Ex, O2, CO, H2S & NiMh battery kit	3501266	D
X-Zone 5500 with pump -X-am 5600 Kit - 4 gas	Includes 120hr battery, Charger, X-am 5600 IR Ex, O2, CO, H2S and NiMh battery kit	3501267	D
Charging Accessories			
Charging Plug		8320749	D
Induction Charger		8322078	D
Replacement Battery	120 hr. 24Ah	8322921	D
Accessories and Spare Parts			
Instrument Holder - Diffusion		8323935	D
Instrument Holder - Pump Operation		8323936	D
Spare connector set (nozzle nut)		8319397	D
Gas Supply Adapter		8323314	D
Alarm Damper		8320110	D
		8320645	D
Stand 30cm			
		8321527	D
Dust and Water Filter for Pump inlet +10cm Viton hose			
Connecting Cable 25m		8321669	D

PORTABLE GAS DETECTION

PRODUCT	DESCRIPTION	PART NO	CATEGORY
---------	-------------	---------	----------

The wireless telemetry system consist of one Draeger Gas Detectors relay output wired into an IECEx approved Oleumtech Wireless Transmitter. This transmits its status to an Oleumtech Base unit at the control room.

The base unit has a 2 x panel indicator lights and 2 x buzzers. During normal operation the Green radio communication light is on to indicate healthy radio link and will go off if communications fail. The Red Alarm indicator will turn on when gas is detected by the gas detector.

The unit has both its communications fail and gas detected, connected to an SMS unit to send an SMS out in the event of an alarm for communications fail or gas detected.

It also has a relay output for an interface to external equipment for communications fail or gas detected.

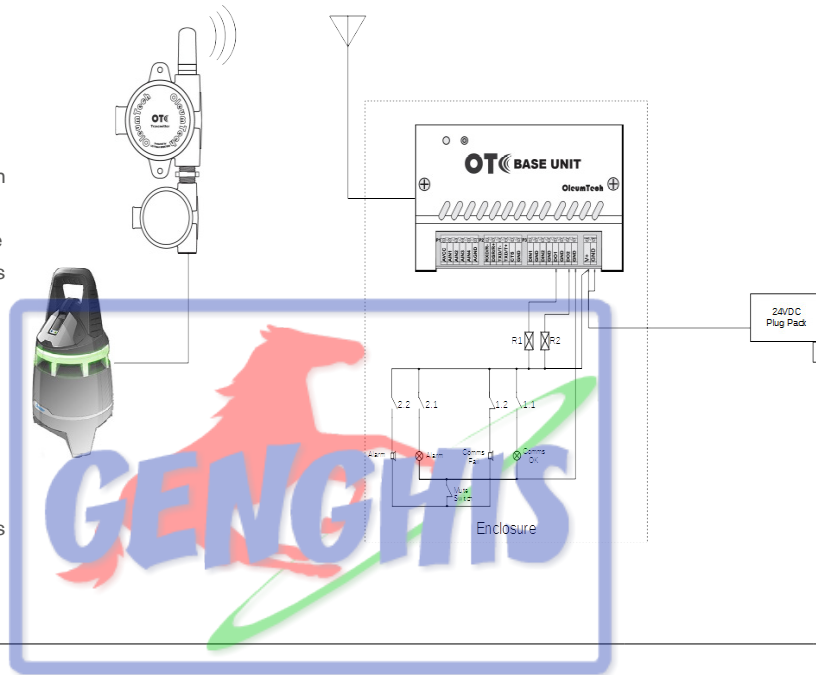

For more details please contact Draeger



Place You Put Your Faith

The Draeger X-zone 5500 can be connected to the external display, such as Draeger RVP 5000.

Draeger RVP 5000		SC00090	H
Draeger RVP 5000 with data logger		SC00091	H
Draeger RVP 5000 with web server and data logger		SC00092	H

PORTABLE GAS DETECTION

PRODUCT	DESCRIPTION	PART NO	CATEGORY
---------	-------------	---------	----------

PAC SERIES - PAC 6000



Pac 6000 single gas 2 year maintenance free concentration display, audible and vibrating alarms.
 Datalogger/Eventlogger, Peak
 Not Renewable
 Warranty 2 years

Pac 6000 H2S

8326320

D

Pac 6000 CO

8326321

D

Pac 6000 O2

8326322

D

Pac 6000 SO2

8326323

D

PAC SERIES - PAC 6500



Pac 6500 single gas unlimited life unit. Concentration display, audible and vibrating alarms.
 Datalogger/Eventlogger, Peak, TWA, STEL
 Warranty 2 years

Pac 6500 H2S

8326330

D

Pac 6500 CO

8326331

D

Pac 6500 O2

8326332

D

Pac 6500 SO2

8326333

D

PORTABLE GAS DETECTION

PRODUCT	DESCRIPTION	PART NO	CATEGORY
---------	-------------	---------	----------

PAC SERIES - PAC 8000



Pac 8000 single gas concentration display, Special sensors, audible and vibrating alarm, replaceable sensor, Peak, TWA, STEL event logger and data logger.

Dräger Pac 8000 NO		8326350	D
Dräger Pac 8000 CO2		8326351	D
Dräger Pac 8000 Cl2		8326352	D
Dräger Pac 8000 HCN		8326353	D
Dräger Pac 8000 NH3		8326354	D
Dräger Pac 8000 PH3		8326355	D
Dräger Pac 8000 OV		8326356	D
Dräger Pac 8000 OV-A		8326357	D
Dräger Pac 8000 NO2		8326358	D
Dräger Pac 8000 Ozone		8326359	D
Dräger Pac 8000 Phosgene		8326360	D

PAC SERIES - PAC 8500



Pac 8500 dual gas - concentration display, dual sensors, audible and vibrating alarm, replaceable sensor, Peak, TWA, STEL event logger and data logger.

Dräger Pac 8500 H2S/CO		8326365	D
Dräger Pac 8500 O2/CO		8326366	D
Dräger Pac 8500 CO H2-CP		8326367	D

PORTABLE GAS DETECTION

PRODUCT	DESCRIPTION	PART NO	CATEGORY
---------	-------------	---------	----------



X-AM 5100

The Dräger X-am 5100 is a small lightweight 1-gas detection instrument which is specially designed for the requirements for personal monitoring.

It can be equipped with an electrochemical sensor either for Hydrogen Peroxide, Hydrazine or for Hydrogen Fluoride / Hydrogen Chloride

Dräger X-am 5100 H2O2 Global	This Includes instrument with corresponding sensor. Battery and power supply not Included.	8326590	D
Dräger X-am 5100 HF/HCl Global	This Includes instrument with corresponding sensor. Battery and power supply not Included.	8326591	D
Replacement Sensors for X-am 5100			
XS EC H2O2	0 - 20 ppm	6809170	D
XS EC HF / HCL	0 - 30 ppm	6809140	D
Power Supply Options			Optional
Battery + Charger Options			
NiMH Charging Set (standard)	NiMH battery & charger with power supply	8318785	D
Battery only Options			D
NiMH T4 Battery only		8318704	D
HC NiMH T4 Battery only		8322244	D
Alkaline Battery Holder T3/T4 (without batteries)	Add 2 x AA Batteries	8322237	D
AA Alkaline Battery - T4	2 required for 8322237	3539163	D
Charger Options			
Charging Set Basic	Module & Single Power supply only	8320333	D
Charging Module only		8318639	D
Power Supply - 5 Amp output	For up to 20 modules	8315805	D
Single charger - 2.5 Amp output	For up to 5 modules	8316994	D
Single charger - 1.25 Amp output	For up to 2 modules	8315635	D
Car Charging Connector	12V or 24V supply	4530057	D
Vehicle charger mounting kit (For one charging module)	(Charging module not Included)	8318779	D

PORTABLE GAS DETECTION

PRODUCT	DESCRIPTION	PART NO	CATEGORY
Additional strap for vehicle charger mounting kit		8318788	D
Accessories			
Protection			
Screen protector X-am 1/2/5000 (Packet of 10)	Protects the display screen from scratches.	8320040	D
Case (without content)	Space for: power supply, probe, Calibration gas cylinder, ext. pump, 3 m Viton hose	8320467	D
Bump Testing and Calibration			
		6806291	D
Calibration Adaptor Viton			
Stainless Steel Regulator 0.5 L/min		6813104	D
Tygon hose PTFE lined 15 M length	good for HCL,Cl2,NH3	4594679	D
Software and Communication			
USB DIRA with USB cable		8317409	D
CC-Vision Basic (Free download from www.draeger.com/software)	Required for setup. Can download data logger		D
GasVision 7 license key (Software download from www.draeger.com/software)	Reports and Trends from Data loggers. License key is supplied. Software must be downloaded from the Dräger website	8325646	D





PORTABLE GAS DETECTION

PRODUCT	DESCRIPTION	PART NO	CATEGORY
X-AM 7000			
		Portable gas detector, for up to 5 sensors (3 x Electrochemical sensors & 2 x Flexible positions for any configuration of Cat Ex, IR or PID sensors). Compatible with CC-Vision & Gas Vision. Data downloading via IR link. Leak Test for Cat Ex sensor mode using Geiger counter principle.	
	2 Year Warranty. Unit comes with rubber boot, carrying strap and calibration adaptor.		
4 = Electrochemical sensors 5 = High powered ports	Please ensure that Data logger and Pump part numbers are on quotes /orders if required.		
Dräger X-am 7000 (construction kit)	Dräger X-am 7000 (sensors, data logger and pump as option available and installed)incl. country specific settings Special configurations (e.g. alarm levels, a wide range of software and sensor settings)	8317400	
Dräger X-am 7000 D	Without pump. Includes Datalogger. Requires power pack, charger and sensors.	8326401	D
Internal pump	With pump adaptor. Needs water & dust filter. Requires hose up to 45m.	8317804	D
Data logger	For later upgrade as part of service only	8318249	D
Charging Accessories			
Charging module	Requires either power supply 8315635 or multiple power supply 8315805	8316487	D
Power Supply Single	For one charging module 8316487	8315635	D
Power Supply	for up to 2 charging modules 8316487.	8316994	D
Multiple Power Supply	For up to 8 charging modules 8316487	8315805	D
Adaptor for vehicles	12/24V. Requires module 8316487	8312645	D
Battery Compartments			
NiMH Power Pack, 4.8V/ 3Ah	> 9 hours (diffusion mode) Warranty 1 year	8317408	D
NiMH Power Pack, 4.8V/ 6Ah	HEAVY DUTY > 20 hours (diffusion mode) Warranty 2 years	8317454	D
Alkaline Battery Compartment	Requires 4x C size batteries 12 hours (diffusion mode)	8317550	D
Accessories and Spare Parts			
Carry Case, Nylon	With belt loop	8317684	D
Leather Carrying Case	With belt loop	8317683	D
Shoulder Strap	With mounting plate	8316878	D
Waist Belt	Requires mounting plate supplied with shoulder strap 8316878	8317682	D
Carrying Clip		8317771	D
	Replacement part, requires water & dust filter trap 8313648	8317639	D
Pump adaptor			
Rubber Boot	Replacement part	8317397	D

PORTABLE GAS DETECTION

PRODUCT	DESCRIPTION	PART NO	CATEGORY	
	Set Sensor membrane	5 pieces	8317805	D
	Sealing Plate complete		8317836	D
	Pump - lower housing		8317406	D
	Car installation holder	For 1 x Charging Cradle	8318169	D
	Spare strap for Car holder		8318105	D
	Plastic Case X-am 7000		8322730	D
Sampling Accessories for All Portable Gas Detectors				
	Hand Aspirator	Requires Cal & Flow - through adaptor	6801933	D
	Water and Dust Filter Trap	For X-am 7000	8313648	D
	Filter Set X-am 125 Attachable Pump	Filter with Luer Lock hose fitting	8319364	D
	Telescopic probe up to 1.0m **	With internal tubing	8316530	D
	Leakage Probe 70 (flexible) **		8316531	D
	** Replacement hose	For 8316530 and 8316531	8318205	D
	ES 150 probe		8316533	D
	Bar Probe 400	400 mm - Good for sampling in Grain	8317188	D



PORTABLE GAS DETECTION

PRODUCT	DESCRIPTION	PART NO	CATEGORY
	90 cm - Not Solvent Resistant!	8316532	D
Bar Probe 90			
Measurement Probe 1.5 m	Good for sampling in Grain	6408239	D
		6807097	D
Float probe with 10m hose			
Float probe	Requires tubing	6802337	D
Tygon hose PTFE lined 15 M length	good for HCL,Cl2,NH3	4594679	D
Sample tubing, Anti-Static	Black, inner diam. 5 mm not for H2S if longer than 5m	1180681	D
Sample tubing, 2m	Solvent resistant with weight at the end	6802279	D
		8325705	D
5 m FKM hose ID 3,2 mm with adapter			
10 m FKM hose ID 3,2 mm with adapter		8325706	D
20 m FKM hose ID 3,2 mm with adapter		8325707	D
		8325831	D
Float probe black EPP, Incl. 3 m FKM hose ID 3,2 mm			
Float probe black EPP, Incl. 10 m FKM hose ID 3,2 mm		8325832	D
		8327654	D
Float probe transparent with luer adapter			

PORTABLE GAS DETECTION

PRODUCT	DESCRIPTION	PART NO	CATEGORY	
	for Pac Ex / Pac II / Pac III / X-am 5100	6806291	D	
	for Miniwarn Comes with instrument	6408135	D	
	Does not come with instrument	8318752	D	
	for X-am 1/2/5 Family			
	for X-am 3000	8317336	D	
		8317656	D	
	for X-am 7000			
	For X-am 8000	8326821	H	
	for X-am 7000 - sensor extension	6809325	D	
Equipment Cases				
	<p><i>Place You Put Your Faith</i></p> <p>Nanuk IP 67 Carry case Internal dimensions specified.</p>			
	X-am 125 Moulded GSE case	For X-am 1/2/5000	8319385	D
	X-am 125 Moulded Large	Space for 103L cylinder and regulators	8320467	D
	Plastic Case X-am 7000		8322730	D
	Dräger X-am 8000 case, plastic, black	w/o content	8327661	H
	Air Liquide Carry Case (Blue)	Blue Plastic, fits 2 cylinders	3549108	D
	Carry Bag for 3 x Cylinders		3502235	D

PORTABLE GAS DETECTION

PRODUCT	DESCRIPTION	PART NO	CATEGORY
Software and Down Load Accessories for Portable Gas Detectors			
GasVision 7 liense key(Graphs)	Reports and Trends from Data loggers. License key is supplied. Software must be downloaded from the Dräger website	8325646	D
CC-Vision Basic (Configuration) Free Download from Internet	Required for setup. Can download data logger		D
CC-Vision E-Cal Free Download from the Internet	Latest CC-Vision software for use with E-Cal system. Included with E-Cal master or module and is Free.		D
Infrared & USB cable connector	Adapter Infrared to USB for Miniwarn, Dräger X-am 1/2/5/7000 & Interlock	8317409	D
 Connection cradle with USB cable	For Pac 3500, 5500 & 7000	8318587	D
Calibration Adaptors			
	Flow through only - No PC connection	8318588	D
for Pac 3500, 5500, 7000 , 6000, 6500, 8000 , 8500			

Place You Put Your Faith

01

SENSORS FOR PORTABLE GAS DETECTORS

Part number	Gas	Measuring Range	Warranty time in months					Dangerous goods	Calibration frequency	Product Group										
			6	12	24	36	60				Pac 3500 / 5500	Pac 7000	X-am 5100	X-am 2000	X-am 2500	X-am 3000	X-am 5000	X-am 5600	X-am 7000	MiniWarn
XXS																				
▶ 6810882	CO	0 - 1999 ppm			X			6	368	X	X	X	X	X	X					X
▶ 6813210	CO-LC	0-2000ppm		X				6	368	X					X	X				X
▶ 6810883	H2S	0 - 200 ppm			X			6	368	X	X	X	X	X	X					X
▶ 6810881	O2	0 - 25 Vol.-%			X			6	368	X	X	X	X	X	X					X
▶ 6811410	CO / H2S DUAL	0 - 2000 / 0 - 200ppm		X				6	368						X	X				X
6812545	Amine	0 - 100 ppm		X				6	368						X	X				X
▶ 6813280	H2S-LC/CO-LC dual	0-100ppm/0-2000ppm		X				6	368						X	X				X
▶ 6813275	O2/CO-LC dual	0-25 Vol%/0-2000ppm		X				6	368						X	X				X
6812010	CO HC	0 - 10000 ppm		X				6	368						X	X				X
6811950	CO-H2 CP	0 - 2000 ppm		X				6	368						X	X				X
6810890	CL2	0 - 20 ppm		X				6	368	X					X	X				X
6810889	CO2	0 - 5 Vol.%		X				6	368	X					X	X				X
6812005	COCI2	0 - 10 ppm	X					6	368	X					X	X				X
6810887	HCN	0 - 50 ppm		X				6	368	X					X	X				X
6813165	HCN PC	0 - 50 ppm		X				6	368	X					X	X				X
6812370	H2	0 - 2000 ppm		X				6	368						X	X				X
6812025	H2 HC	0 - 4 %Vol		X				6	368						X	X				X
6811525	H2S LC (ppb)	0 - 100 ppm			X			6	368						X	X				X
6812015	H2S HC	0 - 1000 ppm		X				6	368						X	X				X
6810888	NH3	0 - 300 ppm		X				6	368	X					X	X				X
▶ 6812600	NO2-LC	0 - 50 ppm		X				6	368	X					X	X				X
6810884	NO2	0 - 50 ppm		X				6	368	X		X			X	X				X
6811545	NO	0 - 200 ppm		X				6	368						X	X				X
6810886	PH3	0 - 20 ppm		X				6	368	X					X	X				X
6812020	PH3 HC	0 - 2000 ppm		X				6	368						X	X				X
6810885	SO2	0 - 100ppm		X				6	368	X		X			X	X				X
6812385	O2 - 100	0 - 100 %Vol		X				6	368						X	X				X
6812535	Odorant	0 - 40 ppm		X				6	368						X	X				X
6811530	OV	0 - 50 ppm		X				6	368	X					X	X				X
6811535	OV-A	0 - 50 ppm		X				6	368	X					X	X				X
XS EC																				
▶ 6809105	CO	0 - 2000 ppm			X			6	368								X	X	X	
▶ 6809110	H2S 100	0 - 100 ppm			X			6	368								X	X	X	
▶ 6809130	O2 - LS	0 - 25 %Vol			X		D	6	368								X	X	X	
6809545	Amine	0 - 100 ppm		X				6	368						X	X	X			
6809165	CL2	0 - 20 ppm		X				6	368						X	X	X			
6811360	CLO2	0 - 20 ppm		X				6	368						X	X	X			
6809120	CO HC	0 - 10,000 ppm		X				6	368						X	X	X			
6809175	CO2	0 - 5 %Vol		X				6	368						X	X	X			
6809185	H2	0 - 2000 ppm		X				6	368						X	X	X			
6811365	H2 HC	0 - 4 %Vol		X				6	368						X	X	X			
6809170	H2O2	0 - 20 ppm		X				6	368		X									X
6809180	H2S HC	0 - 1000 ppm		X				6	368						X	X	X			
6809150	HCN	0 - 50 ppm		X				6	368						X	X	X			
6809140	HF / HCL	0 - 30 ppm		X				6	368		X									X
6809190	Hydrazin	0 - 3 ppm		X				3	368											X
6810295	Hydrazin D	0 - 3 ppm		X				disposable	368											X
6809135	Hydrides	0 - 20 ppm		X			D	6	368						X	X	X			
6809125	NO	0 - 200 ppm		X				6	368						X	X	X			
6809155	NO2	0 - 50 ppm		X				6	368						X	X	X			
6809550	O2 100	0 - 100 %Vol		X				6	368						X	X	X			
6809200	Odorant	0 - 40 ppm		X				6	368						X	X	X			
6809115	OV	0 - 200 ppm		X				6	368						X	X	X			
6809522	OV - A	0 - 100 ppm		X			D	6	368						X	X	X			
6809535	PH3 HC	0 - 1000 ppm		X			D	6	368						X	X	X			
6808582	Phosgene ***	0 - 3 ppm	X					3	368											X

Dräger Region South East Europe | Rev: 0 | Subject to modification! | www.draeger.com

Place You Put Your Faith

- PORTABLE GAS DETECTION
- PERSONAL PROTECTION EQUIPMENT
- DRUG & ALCOHOL DETECTION
- MASKS & FILTERS
- FIRE & GAS DETECTION SYSTEMS
- ENGINEERED SOLUTIONS
- SERVICE, TRAINING & RENTAL
- DIVING TECHNOLOGY

SENSORS FOR PORTABLE GAS DETECTORS

Part number	Gas	Measuring Range	Warranty time in months					Dangerous goods	Calibration frequency	Product Group	Pac 3500 / 5500	Pac 7000	X-am 5100	X-am 2000	X-am 2500	X-am 3000	X-am 5000	X-am 5600	X-am 7000	MiniWarn	Pac III S/E	X-am 8000
			6	12	24	36	60															
6810365	CO	0 - 2000 ppm			X			12	368										X	X	X	
6810370	H2S 100	0 - 100 ppm			X			12	368										X	X	X	
6810375	O2	0 - 25 Vol.-%			X		D	12	368										X	X	X	
6810575	H2S SR	0 - 100 ppm			X			6	368										X	X	X	
6809145	NH3	0-300ppm			X			6	368										X	X	X	
6809160	SO2	0 - 100 ppm			X		D	6	368										X	X	X	
***only for Pac III																						
XS R																						
6810258	CO	0 - 2000 ppm					X	D	6-12	368									X	X	X	
6810260	H2S 100	0 - 100 ppm					X	D	6-12	368									X	X	X	
6810262	O2 - LS	0 - 25 Vol.-%					X	D	6-12	368									X	X	X	
MicroPac																						
6810030	CO	0 - 400 ppm			X		D	24	368						X							
6810032	H2S	0 - 100 ppm			X		D	24	368					X								
6810034	O2	0 - 25 %Vol			X		D	12	368					X								
6810038	HCN	0 - 50 ppm			X			6	368													
6810036	PH3	0 - 20 ppm			X		D	6	368													
6810040	CO2	0 - 5 %Vol			X			6	368													
Commonly used sensors																						
IR Infrared Sensors (IR)																						
6811960	Dual IR Ex/CO2 (X-am 5600)	Ex 0 - 100 %LEL / %Vol CO2 0 - 5 %Vol					X	6-12	305								X					X
6812180	IR Ex (X-am 5600)	Ex 0 - 100 %LEL / %Vol					X	6-12	305								X					X
6812190	IR CO2 (X-am 5600)	CO2 0 - 5 %Vol					X	6-12	305								X					X
6810460	Smart IR-Ex (X-am 7000)	0 - 100 %Vol CH4 0 - 100 %LEL					X	6-12	334									X				
6810590	Smart IR-CO2 (X-am 7000)	0 - 5 %Vol					X	6-12	334									X				
6810599	Smart IR-CO2 HC (X-am 7000)	0 - 100 %Vol CO2					X	6-12	334									X				
Catalytic Explosive Sensors (Cat Ex)																						
6812950	Cat Ex 125 PR	0 - 100 %LEL			X			6	368			X	X		X							X
6813080	Cat Ex 125 Mining PR	0 - 100 %LEL			X			6	368			X	X		X							X
6808280	Ex C	0 - 100 %LEL			X			6	368													X
6810122	Ex C FR	0 - 100 %LEL			X			6	368													X
8316109	Ex 2	0 - 100 %LEL 0 - 100 %Vol CH4			X			6	368						X							
6812980	Smart CatEx (PR)	0 - 100 %LEL			X			6	368										X			
6812970	Smart CatEx (HC PR)	0 - 100 %Vol CH4 0 - 100 %LEL			X			6	368										X			
Photo Ionisation Sensors (PID)																						
8319100	Smart PID				X				334										X			
6813500	DrägerSensor PID LC ppb	for X-am 8000			X																	X
6813475	DrägerSensor PID HC	for X-am 8000			X																	X
8319110	PID lamp replacement				X				953										X			
Commonly used sensors																						
Filters																						
External Water and Dust Filter																						
6808244	Water and Dust Filter for Miniwarn, Pac III, Pac Ex & microPac	Self adhesive. Not for THT, Cl2, NO2, H2O2, Odorant, COCl2 sensors							EA	336												
8323615	Water and Dust Filters for Pac 3500, 5500 & 7000								Packet of 4	953												
8317805	Sensor membrane X-am 7000								Packet of 5	953												
Internal Filter for Electrochemical Sensors																						
6809022	Filter D3T for XS CO sensor	Adsorbs H2S, SO2, NO2 Ethanol							EA	368												
6809198	Filter B2T for XS NO, XS Odorant and XS THT sensor	Adsorbs H2S, SO2, Cl2							Packet of 5	368												
6809163	Filter K1T for XS SO2 sensor	Adsorbs H2S							Packet of 2	368												
6812424	Filter B2X for XXS HCN, HCN- PC sensor	Adsorbs H2S, SO2							Packet of 5	368												
6811344	Filter KX for XXS SO2 sensor	Adsorbs H2S							EA	368												

PORTABLE GAS DETECTION

PRODUCT	DESCRIPTION	PART NO	CATEGORY
Bump Test Equipment and Accessories			
X-DOCK			
	Scalable calibration and configuration station to perform bump tests, create reports & calibration certificates for the portable detectors Dräger X-am 125 and Dräger Pac series and to administrate the gas detector fleet.		
	Set consisting of a master (3 x Cylinder inputs) and one Dräger X-am 125 module. (Limited to 1 Module only) With PSU (No Regulators)	8321880	D
Dräger X-dock 5300 X-am 125			
	Set consisting of a master (3 x Cylinder inputs) and one Pac module. (Limited to 1 Module only) With PSU (No Regulators)	8321881	D
Dräger X-dock 5300 Pac			
	With 3 x Cyl. inputs plus fresh air. Add modules (max. 10). Add PSU. Add regulators (1 per cylinder)	8321900	D
Dräger X-dock 6300 Master			
	With 6 x Cyl. inputs plus fresh air. Add modules (max. 10). Add PSU. Add regulators (1 per cylinder)	8321901	D
Dräger X-dock 6600 Master			
	Cradle for one instrument of the Dräger X-am 125 series. With charging function.	8321891	D
Dräger X-dock Module X-am 125+			
	Cradle for one instrument of the Dräger Pac series.	8321892	D
Dräger X-dock Module Pac			
	X-dock 5300 for X-am 8000 Please contact Dräger for availability.	8326221	H
Dräger X-dock 5300 for X-am 8000			
	Please contact Dräger for availability	8321893	H
Dräger X-dock Module X-am 8000			
	Please contact Dräger for availability	8321894	H
Dräger X-dock Module X-am 8000+ (charging option)			

PORTABLE GAS DETECTION

PRODUCT	DESCRIPTION	PART NO	CATEGORY
Station Accessories			
	One for each cylinder (Not for Cl2, NH3)	8324250	D
X-dock Regulator 0.5 bar fixed			
		8324251	D
X-dock Reg 0.5 bar Incl. flow stop			
	Good for Cl2, NH3	8324252	D
X-dock Reg 0.5 bar stainless steel			
		8324095	D
X-dock hose clamp packed (5 Pcs)			
		8321986	D
Sealing Cartridge X-am Module			
		8321987	D
Sealing Cartridge Pac Module			
		8319364	D
Filter set for pump inlet fresh air pump			
		8321804	D
Spare display protective foil			
		8321839	D
Sticker for module numbering 1 to 10			
		8321974	D
Spare housing pad			
	good for HCL,Cl2,NH3	4594679	D
Tygon hose PTFE lined 15 M length			
		8324095	D
Set of hose clamp (5 pcs.)			
Scanner Accessories			
	CINO FBC6860LR	8318792	D
Barcode scanner			
	Outside use, 22 x 8 mm (500 labels per scroll)	AG02551	D
Barcode label			
Power Supplies			
	For up to 3 modules	8321849	D
Power supply 100-240 V; 24 VDC / 1.25 A			
	For up to 10 modules	8321850	D
Power supply 100-240 V; 24 VDC / 6.25 A			
		8321855	D
Vehicle connection 12 V / 24 VDC			
	(adjustable tipping angle)	8321910	D
Wall bracket comfort			

Dräger Region South East Europe | Rev: 0 | Subject to modification! | www.draeger.com

Place You Put Your Faith

PORTABLE
GAS DETECTION

PERSONAL
PROTECTION
EQUIPMENT

DRUG & ALCOHOL
DETECTION

MASKS & FILTERS



FIRE & GAS
DETECTION
SYSTEMS

ENGINEERED
SOLUTIONS

SERVICE,
TRAINING & RENTAL

DIVING
TECHNOLOGY

PORTABLE GAS DETECTION

PRODUCT	DESCRIPTION	PART NO	CATEGORY
		8321922	D
Wall bracket basic			
	(table version)	8321918	D
Cylinder holder			
	(for DIN rail / wall bracket)	8321928	D
Cylinder holder wall mount			
Software Licenses			
GasVision 7 license key (Software download from www.draeger.com/ software)	Use this software in-conjunction with XDM for data analysis.	8325646	D
Dräger X-dock Manager Professional	(Initial license)	8321870	D
Dräger X-dock Manager License (1)	Further license for one additional PC (both versions)	8321857	D
Dräger X-dock Manager License (5)	Further license for five additional PCs (both versions)	8321858	D

PORTABLE GAS DETECTION

PRODUCT	DESCRIPTION	PART NO	CATEGORY
---------	-------------	---------	----------

AUTOMATIC BUMP TEST STATIONS



Bump tests the instrument automatically. Requires 58 or 103 Litre cylinder. No printer available.

Add Test Gas as required

Bump test Station Pac Series	No link to Mobile printer	8317410	D
Bump test Station X-am 7000		8318909	D
Bump test Station X-am 7000 with Printer		8321009	D
Bump test Station X-am 125		8319131	D
Equipment for Manual Bump Testing			
Calibration adaptor for X-am 1/2/5 Family		8318752	D
Calibration adaptor for X-am 7000		8317656	D
Calibration adapter X-am 8000		8326821	H
Tygon hose PTFE lined 15 M length	good for HCL,Cl ₂ ,NH ₃	4594679	D
Stainless Steel Regulator 0.5 L/min	Good for CL ₂ or NH ₃ & HCL	6813104	D
Calibration adaptor for Pac X-am 5100 / Pac III / Pac Ex		6806291	D
PC Communication cable (mini-USB)		8318657	D

Regulators



0.5 L/min Constant Flow - C10

6813104

D

Stainless Steel Regulator



0.5 bar Constant Pressure - C10
(see X-dock Section for more options on regulators)

8324250

D

X-dock Regulator

PORTABLE GAS DETECTION

PRODUCT	DESCRIPTION	PART NO	CATEGORY
On demand regulator model 2001		8316556	
Standard regulator	0.5 l/min, nickel plated brass, 5/8"-18 UNF	6810397	
Stainless steel regulator	0.5 l/min, 5/8"-18 UNF For better results use one regulator for one gas type only	6813104	
Trigger regulator	0.5 l/min, nickel plated brass, 5/8"-18 UNF	6810649	
Multi flow regulator C-10	flow adjustable to: 0 l/min; 0.5 l/min; 0.75 l/min; 1 l/min; 1.5 l/min; 2 l/min; 2.5 l/min; 3 l/min; 4 l/min; 5 l/min	4930604	
Regulator Dräger Multi-PID 2		6810688	
Regulator Dräger E-Cal	DFR 2003 + DIN477 no. 14 adapter for refillable cylinders	6810692	
Spare O-ring for C10 valves	5/8"x18	8324288	
Accessories			
Carrying Case		6811181	
Puncher Tool		6811182	

All regulators are set to a flow of 0.5 liter/minute

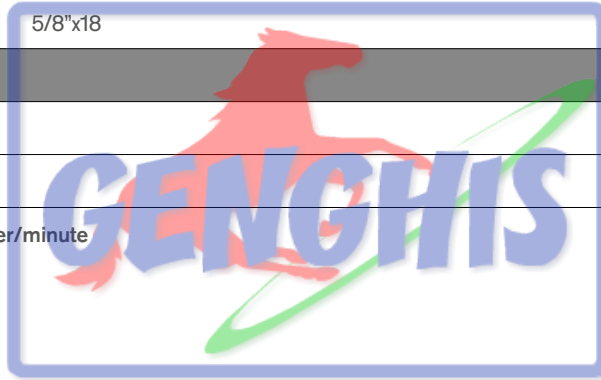

Place You Put Your Faith

PORTABLE GAS DETECTION

PRODUCT	DESCRIPTION	PART NO	CATEGORY
---------	-------------	---------	----------

PORTABLE INSTRUMENTS FOR EMISSION CONTROL - DRÄGER MSI



Measurement device for the measurement of VOCs benzene and / or 1.3 butadiene selectively

Consisting of: sensor unit and power supply, control unit with preinstalled Mobile App, power supply and charging cable, shoulder strap, 2 water and dust filter, gassing adapter

Dräger X-pid 9000

68 51 847

D



Measurement device for the measurement of VOCs - various VOCs selectively

Consisting of: sensor unit and power supply, control unit with preinstalled Mobile App, power supply and charging cable, shoulder strap, 2 water and dust filter, gassing adapter

Dräger X-pid 9500

68 51 848

D



Diesel Exhaust Emission Analyser with robust housing, datalogging, built in IR interface, sensors for CO (0-4000 ppm), NO (0-2000 ppm) & NO2 (0-200 ppm).

NOx concentration calculated based on NO+NO2 levels.

Vehicle exhaust probe inc. 3m hose, gas preconditioner with condensate trap and charger all packed in an IP67 carry case.

Place You Put Your Faith

Set Dräger FG4200 Incl. Dräger FG4200

USB plug-in charger, mini USB cable, gas probe, bumper set FG4200, bag, software*

5603061

D

Option Bluetooth

56 06 006

D



Dräger FG4200
Instrument for flue gas analysis

XXL performance in an exceptionally handy, compact format, weighing only 258 grams. The flue gas analysis device Dräger FG4200 is a master in its class and fulfils all service and maintenance requirements precisely, quickly and reliably. We offer different versions of appliance.

For the measurement of oxygen, carbon monoxide, combustion air temperature, flue gas temperature and pressure. Incl. colored touch-screen, integrated help function and customer data management. Set Dräger FG4200 Incl. printer Incl. Dräger FG4200, USB plug-in charger, mini USB cable, gas probe, infrared printer MSI IR3, bag, software*

5603068

D

The software is available for download on www.draeger-msi.de Please contact Draeger for more information

PORTABLE GAS DETECTION

PRODUCT	DESCRIPTION	PART NO	CATEGORY
 <p>Dräger FG7000 Instrument for flue gas analysis</p>	<p>The new intuitive operating concept and the large coloured touchscreen simplifies the daily workflow. Measurements are quicker and easier to be done due to the plugable gaspreconditioner and the new connective probe system. We offer different versions of appliance.</p> <p>For the measurement of oxygen, carbon monoxide, nitrogen monoxide, combustion air temperature, flue gas temperature, low pressure and differential pressure. The capacitive coloured touchscreen allows a quicker and more effective operation. The Dräger FG7000 is operated using the capacitive touchscreen display. You can execute the tapping and swiping function on the screen with your finger.</p> <p>Dräger Set FG7000 NO Incl. Dräger FG7000, plug-in charger, USB cable, gas probe with integrated draft measurement, gas pressure hose, equipment case, consumable set FG7000, NO measuring channel, software*</p>	5603085	D
**The software is available for download on www.draeger-msi.de			
 <p>Dräger P4000 Instrument for pressure- and tightness measurements</p>	<p>The multi-functional Dräger P4000 for inspection assignments on Natural gas pipelines, liquefied petroleum gas pipelines and drinking water installations is remarkable for its light weight and handy size. A modern coloured touch-screen guarantees intuitive use of the device.</p> <p>For inspection assignments on natural gas pipelines, liquefied petroleum gas pipelines and drinking water installations. The Dräger P4000 leak tightness test system contains ready-made measuring programs</p> <p>Set Dräger P4000 3.5 bar (25 bar version is also available) Incl. pressure measuring instrument Dräger P4000, USB cable, USB power supply, pressure hose P4000, pump adapter 150 mbar with quick coupling and valve connection, pressure sensor EP35 with quick coupling and valve connection, 1/2" adapter with quick coupling, single pipe cap with quick coupling, hand pump, case, software*</p>	5603059	D
*The software is available for download on www.draeger-msi.de			
	<p>The leak detector for combustible gases has been developed for the location of leakage at gas installations in handcraft and industry. The Dräger GS2 is characterized by small size and easy handling</p> 	5600820	D

PORTABLE GAS DETECTION

PRODUCT	DESCRIPTION	PART NO	CATEGORY
Optional Items			
IR Printer for MSI		5600401	D
Paper for IR Printer	6 Pieces	5690151	D
Software DEXAS	Dexas allows you to transfer Data directly from a MSI EM200 E instrument to Excel, download free from: http://www.draeger-msi.de/index.php/download-en/category/6-programs		
USB-Cable	For data downloading to PC	8318657	D
Accessories and Spare Parts			
MSI EM 200-E / 150 E Vehicle Exhaust Probe		5600362	D
MSI Gas Tube per Meter		5630051	D
Gas probe	Length 150 mm, for gas and temperature measurement, Incl. 2.5 m line and mounting cone	5600298	D
Gas probe	Length 300 mm, for gas and temperature measurement, Incl. 2.5 m line and mounting cone	5600439	D
Multi hole probe	5 to 15 cm, 1.5 m line and mounting cone	5600020	D
Gas pressure probe	1.0 m hose with quick connector for measurement of gas flow and flow pressure of gas burners	5600365	D
Power Supply for MSI EM200		8315635	D
Combustion air temperature sensor	Quick response	5600352	D
Extension	3 m for combustion air temperature sensor	5600517	D
Air temperature probe	Length 270 mm	5600530	D
Magnetic holder	For 5600530	5600096	D
Magnetic holder	For 5600356	5600528	D
Disc filter for gas-preconditioner	10 Pieces	5600093	D
Filter fleece for gas-preconditioner	10 Pieces, dia. = 26 mm	5630250	D
Gas-preconditioner complete		5610456	D
Battery EM200		5680105	D

PORTABLE GAS DETECTION

PRODUCT	DESCRIPTION	PART NO	CATEGORY
---------	-------------	---------	----------

DRÄGER MULTI-PID2 (NO LONGER AVAILABLE - SPARE PARTS ONLY)



Charging Accessories		
Charger (World wide)	220 V	8317661
12 V DC Adapter		6405421
Offline Charger	For recharging external battery pack separately Requires 8317661	6405404
Accessories and Spare Parts		
10.6 eV detector lamp		8318307
UV Lamp Cleaning Kit	Includes Aluminium oxide powder and cotton swabs	8318318
Benzene Pre Tube	Packet of 10	8103511
Humidity Pre Tube	Packet of 10	8103531
Sample bag		6405429
17 cm sample probe teflon		6405412
Dilution probe	To extend measuring range to 20,000 ppm	8317678
Replacement Dilution-Probe Carbon Filter	1 piece	6405408
Sample Line	3 m Teflon	6405411

PORTABLE GAS DETECTION

PRODUCT	DESCRIPTION	PART NO	CATEGORY
---------	-------------	---------	----------

DRÄGER X-ACT® 5000



Dräger X-act 5000 is the new Ex-approved automatic Dräger-Tube pump for the Measurement OR Sample taking of gasses, vapours and aerosols.

The Dräger X-act 5000 is used in conjunction with Dräger Short Term OR Sampling Tubes and systems. It is corrosion resist and its robust housing allows for it to be used under tough conditions on a daily basis while the user replaceable sulphur trioxide aerosol filter will protect the pump for up to 2 years.

Dräger X-act 5000	With shoulder strap. Add Power Supply	4523500	D
Power Packs			
Rechargeable Battery NiMH, T4		4523520	D
Alkaline Battery Pack, T4 w/o Batteries	Batteries needed	4523525	D
Charging Accessories			
Wall-Wart Charger (100 - 240 VAC)	Worldwide	4523545	D
Car Charger (12 / 24 VDC)		4523511	D
Accessories			
SO3 Filter Replacement		8103525	D
Shoulder Strap		4523565	D
Resistant Tube (Dosage)		6527562	D



Tube Opener Dräger TO 7000

Extension Hose			
----------------	--	--	--





Incl. Adapter for Simultaneous Test Set

6400561

D

Extension hose 1 m,
Dräger Accuro & Dräger X-act 5000

PORTABLE GAS DETECTION

PRODUCT	DESCRIPTION	PART NO	CATEGORY
	Incl. Adapter for tubes, adapter for hose in a carry box	6400077	D
Extension hose 3 m, Dräger Accuro & Dräger X-act 5000			
	Incl. Adapter for tubes, adapter for hose	6400078	D
Extension hose 10 m, Dräger Accuro & Dräger X-act 5000			
Extension hose 30 m, Dräger X-act 5000	Incl. Adapter for tubes, adapter for hose	6401175	D

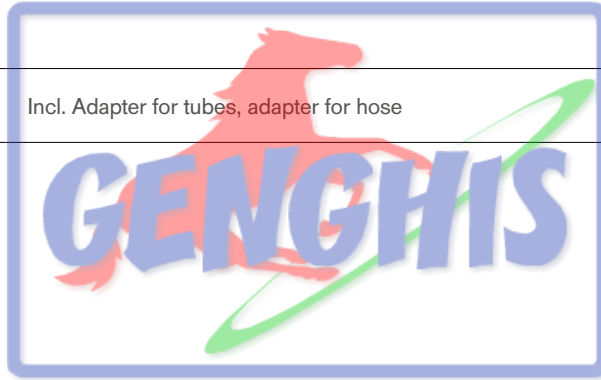

Place You Put Your Faith

PORTABLE GAS DETECTION

PRODUCT	DESCRIPTION	PART NO	CATEGORY
---------	-------------	---------	----------

SHORT TERM MONITORING PUMP - ACCURO



The Accuro pump together with Dräger's broad range of short term detector tubes, provide a convenient and simple method for determining the presence and or concentration of specific airborne contaminants. This bellows type pump draws 100cm³ of air with each pump stroke. It has a pressure controlled end of stroke indicator located in the pump head. An internal spring loaded scissors mechanism ensures an even and reproducible compression of the bellows is achieved with each pump stroke.

Accuro Multigas Detector Pump

Includes heavy duty tube opener

6400000

D



Accuro Multigas Detector Kit

Includes carry case, spares kit and heavy duty tube opener

6400260

D



Tube Opener Dräger TO 7000

6401200

D

Place You Put Your Faith

Extension Hose



Extension hose 1 m,
Dräger Accuro & Dräger X-act 5000

Incl. Adapter for Simultaneous Test Set

6400561

D



Extension hose 3 m,
Dräger Accuro & Dräger X-act 5000

Incl. Adapter for tubes, adapter for hose in a carry box

6400077

D

PORTABLE GAS DETECTION

PRODUCT	DESCRIPTION	PART NO	CATEGORY
---------	-------------	---------	----------



Extension hose 10 m,
Dräger Accuro & Dräger X-act 5000

Incl. Adapter for tubes, adapter for hose

6400078

D

Extension hose 15 m ,
Dräger Accuro & Dräger X-act 5000

Incl. Adapter for tubes, adapter for hose

6400079

D

Accessories and Spare Parts for Multigas Detector Pumps

The hot air probe is engineered for the measurement of hot gases, such as flue gases above 40 degrees Celsius. Dräger's hot air probe is designed to cool down hot gases so they can be measured quickly and directly using Dräger's detector tubes. Probe length 250 mm.



Hot Air Probe

Dräger's Exhaust Probe is designed to directly analyse the exhaust emissions expelled from internal combustion engines.

CH00213

D

Dräger's Exhaust Probe is designed to directly analyse the exhaust emissions expelled from internal combustion engines.



Vehicle Exhaust Probe

Dräger's manifold probe was designed to meet the specific requirements of the coal mines in Australia. Attached to the manifold, the manifold probe is used as an accessory to quickly and easily analyse the emissions from internal combustion engines.

CH00214

D

Dräger's manifold probe was designed to meet the specific requirements of the coal mines in Australia. Attached to the manifold, the manifold probe is used as an accessory to quickly and easily analyse the emissions from internal combustion engines.

PORTABLE GAS DETECTION

PRODUCT	DESCRIPTION	PART NO	CATEGORY
---------	-------------	---------	----------

SHORT TERM MONITORING TUBES (ALPHABETICAL ORDER)



For use with Däger Accuro Hand Pump or Däger X-act 5000 Automatic Pump.

	Measuring Range	DG Status		
Acetaldehyde 100/a	100 - 1000 ppm		6726665	C
Acetic Acid 5/a	5 - 80 ppm		6722101	C
Acetone 40/a (5)	40 - 800 ppm		8103381	C
Acetone 100/b	100 -12,000 ppm		CH22901	C
Acid Test	Qualitative		8101121	C
Acrylonitrile 0.2/a			8103701	C
Air Current Tubes	Qualitative	DG	CH25301	C
Amine Test	Qualitative		8101061	C
Ammonia 0.25/a	0.25 - 3 ppm		8101711	C
Ammonia 2/a	2 -30 ppm		6733231	C
Ammonia 5/a	5 - 700 ppm		CH20501	C
Ammonia 5/b	5 - 100 ppm		8101941	C
Ammonia 0.5%/a	0.5 - 10 %Vol		CH31901	C
Aniline 0.5/a	0.5 - 10 ppm		6733171	C
Aniline 5/a	1 - 20 ppm		CH20401	C
Arsine 0.05/a	0.05 - 60 ppm		CH25001	C
Benzene 0.25/a	0.25-10ppm		8103691	C
Benzene 1/a	1 ppm		8103641	C
Benzene 2/a (5)	2 - 60 ppm	DG	8101231	C
Benzene 5/a	5 - 40 ppm		6718801	C
Benzene 5/b	5 - 50 ppm	DG	6728071	C
Benzene 15/A	15 - 420 ppm	DG	8101741	C
Benzene Pre Tube	Used with PID		8103511	C
n-Butanol 10/a	10-2000ppm		8103861	C
Carbon Dioxide 100/a	100 - 3000 ppm		8101811	C
Carbon Dioxide 100/a-P	100 - 3000 ppm		6728521	C
Carbon Dioxide 0.1%/a	0.1 - 6 %Vol		CH23501	C
Carbon Dioxide 0.5/a	0.5 - 10 %Vol		CH31401	C
Carbon Dioxide 1%/a	1 - 20 %Vol		CH25101	C
Carbon Dioxide 5%/A	5 - 60 %Vol		CH20301	C
Carbon Disulphide 3/a	3 - 95 ppm		8101891	C

Dräger Region South East Europe | Rev: 0 | Subject to modification! | www.draeger.com

Place You Put Your Faith

PORTABLE
GAS DETECTION

PERSONAL
PROTECTION
EQUIPMENT

DRUG & ALCOHOL
DETECTION

MASKS & FILTERS

FIRE & GAS
DETECTION
SYSTEMS

ENGINEERED
SOLUTIONS

SERVICE,
TRAINING & RENTAL

DIVING
TECHNOLOGY

PORTABLE GAS DETECTION

PRODUCT	DESCRIPTION	PART NO	CATEGORY	
Carbon Disulphide 5/a	5 - 60 ppm	DG	6728351	C
Carbon Disulphide 30/a	0.1 - 10 mg/L		CH23201	C
Carbon Monoxide 2/a	2 - 300 ppm	DG	6733051	C
Carbon Monoxide 5/c	5 - 700 ppm	DG	CH25601	C
Carbon Monoxide 8/a (Only For CO In H2)	8 - 150 ppm	DG	CH19701	C
Carbon Monoxide 10/b	10 - 3000 ppm	DG	CH20601	C
Carbon Monoxide 0.3%/b	0.3 - 7 %Vol	DG	CH29901	C
Carbon Tetrachloride 0.1/a	0.1 - 5 ppm		8103501	C
Carbon Tetrachloride 1/a (5)	1 - 15 ppm		8101021	C
Chlorine 0.2/a	0.2 - 30 ppm		CH24301	C
Chlorine 0.3/b	0.3 - 10 ppm		6728411	C
Chlorine 50/a	50 - 500 ppm		CH20701	C
Chlorine Dioxide 0.025/a Specific	0.025 - 1 ppm		8103491	C
Chloroform 2/a (5)	2 - 10 ppm	DG	6728861	C
Chloroformates 0.2/b	0.2 - 10 ppm		6718601	C
Chloroprene 5/a	5 - 90 ppm		6718901	C
Chlorpicrine 0.1/a	0.1 - 2 ppm		8103421	C
Chromic Acid 0.1/a (9)	0.1 - 0.5 mg/m3		6728681	C
Cyanide 2/a	2 - 15 mg/m3		6728791	C
Cyanogen Chloride 0.25/a	0.25 - 5 ppm		CH19801	C
Cyclohexane 40/a	40- ppm		8103671	C
Dichloropropene 0.1/a	0.1 - 10 ppm		8103551	C
Diesel Fuel	25 - 200 mg/m3		8103475	C
Diethyl Ether 100/a	100 - 4000 ppm		6730501	C
Dimethyl Formamide 10/b	10 - 40 ppm		6718501	C
Dimethyl Sulphate 05/c (9)	05 - 0.05 ppm		6718701	C
Dimethyl Sulphide 1/a (5)	1 - 15 ppm		6728451	C
Epichlorohydrin 5/c	5 - 80 ppm		6728111	C
Ethanol 100/a	100-3000ppm		8103761	C
Ethyl Benzene 30/a	30 - 400 ppm		6728381	C
Ethyl Glycol Acetate 50/a	50 - 700 ppm		6726801	C
Ethylene 0.1/a (5)	0.2 - 5 ppm		8101331	C
Ethylene 50/a	50 - 2500 ppm	DG	6728051	C
Ethylene Glycol 10 (5)	10 - 180 mg/m3		8101351	C
Ethylene Oxide 1/a (5)	1 - 15 ppm		6728961	C
Ethylene Oxide 25/a	25 - 500 ppm		6728241	C
Fluorine 0.1/a	0.1 - 2 ppm		8101491	C
Formaldehyde 0.2/a	0.2 - 5 ppm		6733081	C

PORTABLE GAS DETECTION

PRODUCT	DESCRIPTION	PART NO	CATEGORY
Formaldehyde Activation Tube	Only for use with Formaldehyde 0.2/a (6733081).	8101141	C
Formaldehyde 2/a	2 - 40 ppm	8101751	C
Halogenated Hydrocarbon 100/a (8)	200 - 2600 ppm	DG 8101601	C
Hydrocarbon 0.1%/c	0.1 - 1.3 Vol%	DG 8103571	C
Hexane 10/a	10- ppm	8103681	C
Hydrazine 0.01/a	0.01 - 6 ppm	8103351	C
Hydrazine 0.25/a	0.1 - 10 ppm	CH31801	C
Hydrochloric Acid 1/a	1 - 10 ppm	CH29501	C
Hydrochloric Acid / Nitric Acid 1/a	1 - 10 ppm	8101681	C
Hydrochloric Acid Nitric Acid	1 - 15 ppm		
Hydrocyanic Acid 0.5/a	0.5 - 50 ppm	8103601	C
Hydrogen 0.2%/a	0.2 - 2 %Vol	8101511	C
Hydrogen 0.5%/a	0.5 - 3 %Vol	CH30901	C
Hydrogen Fluoride 0.5/a	0.5 - 90 ppm	8103251	C
Hydrogen Fluoride 1.5/b	1.5 - 15 ppm	CH30301	C
Hydrogen Peroxide 0.1/a	0.1 - 3 ppm	8101041	C
Hydrogen Sulphide 0.2/a	0.2 - 5 ppm	8101461	C
Hydrogen Sulphide 0.2/b	0.2 - 6 ppm	8101991	C
Hydrogen Sulphide 0.5/a	0.5 - 15 ppm	6728041	C
Hydrogen Sulphide 1/c	1 - 200 ppm	6719001	C
Hydrogen Sulphide 1/d	1 - 200 ppm	8101831	C
Hydrogen Sulphide 2/a	2 - 200 ppm	6728821	C
Hydrogen Sulphide 2/b	2 - 60 ppm	8101961	C
Hydrogen Sulphide 5/b	5 - 600 ppm	CH29801	C
Hydrogen Sulphide 100/a	100 - 2000 ppm	CH29101	C
Hydrogen Sulphide 0.2%/A	0.2 - 7 %Vol	CH28101	C
Hydrogen Sulphide 2%/a	2 - 40 %Vol	8101211	C
Hydrogen Sulphide & Sulphur Dioxide 0.2%/a	0.2 - 7 %Vol	CH28201	C
Iodine 0.1/a	0.1 - 5 ppm	8103521	C
Mercaptan 0.1/a	0.1 - 15 ppm	8103281	C
Mercaptan 0.5/a	0.5 - 5 ppm	6728981	C
Mercaptan 20/a	20 - 100 ppm	8101871	C
Mercury Vapour 0.1/b	0.05 - 2 mg/m ³	CH23101	C
Methanol 20/a	20-5000ppm	8103801	C
Methyl Acrylate 5/a	5 - 200 ppm	DG 6728161	C
Methyl Bromide 0.2/a	0.2 - 8 ppm	8103391	C

PORTABLE GAS DETECTION

PRODUCT	DESCRIPTION	PART NO	CATEGORY
Methyl Bromide 0.5/a	0.2 - 30 ppm	8101671	C
Methyl Bromide 3/a (5)	3 - 100 ppm	6728211	C
Methyl Bromide 5/b	5 - 50 ppm	CH27301	C
Motor Fuels Detector (as n-Octane)	200 - 5000 ppm	DG 6400491	C
Natural Gas Odorization (Tertiary Butyl mercaptan)	1 - 15 mg/m ³	8103071	C
Nickel Tetracarbonyl 0.1/a (9)	0.1 - 1 ppm	CH19501	C
Nitrogen Dioxide 0.1/a	0.1 - 30 ppm	8103631	C
Nitrogen Dioxide 2/c	2 - 100 ppm	6719101	C
Nitrous Fumes 0.2/a [NO+NO ₂]	0.2 - 6ppm	8103661	C
Nitrous Fumes 2/a [NO+NO ₂]	2 - 100 ppm	CH31001	C
Nitrous Fumes 20/a [NO+NO ₂]	20 - 500 ppm	6724001	C
Nitrous Fumes 50/b	50-4000ppm	8103941	C
Oil Mist 1/a	1 - 10 mg/m ³	DG 6733031	C
Oil 10/a-P	0.1 - 10 mg/m ³	DG 6728371	C
Olefine 0.05%/a Butylene	0.04 - 2.4 %Vol	CH31201	C
Organic Based Nitrogen Compounds	1 mg/m ³ threshold	CH25903	C
Oxygen 5%/B (8)	5 - 23 %Vol	DG 6728081	C
Oxygen 5%/C	5 - 23 %Vol	DG 8103261	C
Ozone 0.05/b	0.5 - 1.4 ppm	6733181	C
Ozone 10/a	20 - 300 ppm	CH21001	C
Pentane 100/a	100-1500 ppm	6724701	C
Perchloroethylene 0.1/a	0.1 - 4 ppm	8101551	C
Perchloroethylene 2/a	2 - 300 ppm	8101501	C
Perchloroethylene 10/b	10 - 500 ppm	CH30701	C
Petroleum Hydrocarbons 10/a [N-Octane]	10 - 300 ppm	8101691	C
Petroleum Hydrocarbons 100/a [N-Octane]	100 - 2500 ppm	6730201	C
Phenol 1/b	1 - 20 ppm	8101641	C
Phosgene 0.02/a	0.02 - 1 ppm	8101521	C
Phosgene 0.05/a	0.04 - 1.5 ppm	CH19401	C
Phosgene 0.25/c	0.25 - 5 ppm	CH28301	C
Phosphine 0.01/a	0.01 - 1 ppm	8101611	C
Phosphine 0.1/c	0.1-3ppm	8103711	C
i-Propanol 50/a	50-4000ppm	8103741	C
Phosphine 0.1/b in Acetylene	0.1 - 15 ppm	8103341	C
Phosphine 1/a	1 - 100 ppm	8101801	C
Phosphine 50/a	50 - 1000 ppm	CH21201	C
Phosphoric Acid Esters 0.05/a	0.05 ppm	6728461	C

PORTABLE GAS DETECTION

PRODUCT	DESCRIPTION	PART NO	CATEGORY	
Polytest	Qualitative	DG	CH28401	C
Simultaneous Test Set I (5) (Inorganic)			8101735	C
Simultaneous Test Set II (5) (Inorganic)			8101736	C
Simultaneous Test Set III (5) (Organic)			8101770	C
Simultantest Container Fumigation			8103380	C
Styrene 10/a	10 - 200 ppm		6723301	C
Styrene 50/a	50 - 400 ppm		CH27601	C
Sulphuryl Fluoride 1/a	1 - 5 ppm		8103471	C
Sulphur Dioxide 0.1/a	0.1 - 3 ppm		6727101	C
Sulphur Dioxide 0.5/a	0.5 - 25 ppm		6728491	C
Sulphur Dioxide 1/a	1 - 25 ppm		CH31701	C
Sulphur Dioxide 20/a	20 - 200 ppm		CH24201	C
Sulphur Dioxide 50/b	50 - 8000 ppm		8101531	C
Sulphuric Acid 1/a (9)	1 - 5 mg/m ³		6728781	C
Tertiary Butylmercaptan - Natural Gas Odorization	1 - 15 mg/m ³		8103071	C
Thioether	1 mg/m ³ threshold		CH25803	C
Toluene 5/b	5-300 ppm		8101661	C
Toluene 50/a	50 - 400 ppm		8101701	C
Toluene 100/a	100 - 1800 ppm		8101731	C
Toluene Diisocyanate 0.02/A (9)	0.02 - 0.2 ppm		6724501	C
Trichlorethylene 2/a	2 - 250 ppm		6728541	C
Trichlorethylene 50/a	50 - 500 ppm		8101881	C
Triethylamine 5/a	5 - 60 ppm		6718401	C
Vinyl Chloride 100/a	100 - 3000 ppm		CH19601	C
Water Vapour 0.1	1 - 40 mg/L		CH23401	C
Water Vapour 0.1/a	0.1 - 1.0 mg/L		8101321	C
Water Vapour 1/b	1 - 40 mg/L		8101781	C
Xylene 10/a	10 - 400 ppm	DG	6733161	C

PORTABLE GAS DETECTION

PRODUCT	DESCRIPTION	PART NO	CATEGORY
---------	-------------	---------	----------

LONG TERM MONITORING - DIFFUSION TUBES



Direct Indicating Diffusion Tubes (for long term monitoring - 8 hours).

The Dräger Direct-Reading Diffusion Tubes employ the principles of gaseous diffusion to enable the user to measure time weighted average concentrations for periods of up to 8 hours. To use simply insert the opened diffusion tube into the tube holder and attach to a pocket or lapel and note the starting time.

Diffusion Tube	Standard Range of measurement for 1 hour	Measurement range for 8 hrs		
Diffusion Tube Holder	(Packet of 3)		6733014	C
Acetic Acid 10/a-D	10 - 200 ppm	1.3 - 25 ppm	8101071	C
Ammonia 20/a-D	20 - 1500 ppm	2.5 - 200 ppm	8101301	C
Butadiene 10/a-D	10 - 300 ppm	1.3 - 40 ppm	8101161	C
Carbon Dioxide 1%/a-D	1 - 30 %Vol	0.13 - 4 %Vol	8101051	C
Carbon Dioxide 500/a-D	500 - 20000 ppm	65 - 2500 ppm	8101381	C
Carbon Monoxide 50/a-D	50 - 600 ppm	6 - 75 ppm	6733191	C
Ethanol 1000/a-D	1000 - 25000 ppm	125-3100 ppm	8101151	C
Hydrochloric Acid 10/a-D	10 - 200 ppm	1.3 - 25 ppm	6733111	C
Hydrocyanic Acid 20/a-D	20 - 200 ppm	2.5 - 25 ppm	6733221	C
Hydrogen Sulfide 10/a-D	10 - 300 ppm	1.3 - 40 ppm	6733091	C
Nitrogen Dioxide 10/a-D	10 - 200 ppm	1.3 - 25 ppm	8101111	C
Sulfur Dioxide 5/a-D	5 - 150 ppm	0.7 - 19 ppm	8101091	C
Toluene 100/a-D	100 - 3000 ppm	13 - 380 ppm	8101421	C
Trichloroethylene 200/a-D	200 - 1000 ppm	25 - 125 ppm	8101441	C

PORTABLE GAS DETECTION

PRODUCT	DESCRIPTION	PART NO	CATEGORY
---------	-------------	---------	----------

DRÄGER SAMPLING TUBES FOR PASSIVE MONITORING



Passive sampling is performed with diffusion samplers like the Dräger ORSA or the Dräger Nitrous Oxide diffusion samplers. In contrast to active sampling the transport of the contaminant molecules is achieved by diffusion processes and not by using a pump. Contaminant molecules from the ambient air follow a defined diffusion course and are absorbed by the sorption agent of the diffusion sampler. The sample is then analysed in the laboratory by means of various analytical methods.

ORSA 5	Activated Charcoal from coconut shell charcoal with: 5 x sampling tubes, 5 x transportation jars, 5 x tube holders sample protocols & user instructions.	6728891	C
ORSA 25	Activated Charcoal from coconut shell charcoal with: 25 x sampling tubes, 25 x transportation jars, 25 x tube holders sample protocols & user instructions.	6728919	C
Nitrous Oxide	Molecular Sieve (Laughing Gas) Requires holder 6733014 (Packet of 10)	8101472	C
	(Packet of 3)	6733014	C
Diffusion Tube Holder			

Place You Put Your Faith

PORTABLE GAS DETECTION

PRODUCT	DESCRIPTION	PART NO	CATEGORY
---------	-------------	---------	----------

LONG TERM MONITORING



Dräger Sampling Tubes and Systems for Active Sampling. For active sampling the air to be evaluated is drawn through the sampling tube with a constant flow pump or X-act 5000. The substance to be collected accumulates on the adsorbent. The sample is then analysed in the laboratory by means of various analytical methods.

Dräger Tube	Primary Adsorption Layer	Backup Adsorption Layer		
Activated Charcoal Tube Type NIOSH	100 mg	50 mg	6728631	C
Activated Charcoal Tube Type B/G	300 mg	700 mg	8101821	C
Activated Charcoal Tube Type B	300 mg	700 mg	6733011	C
Activated Charcoal Tube Type G	750 mg	250 mg	6728831	C
Silica Gel Tube Type NIOSH	140 mg	70 mg	6728811	C
Silica Gel Tube Type B/G	480 mg	1100 mg	8101861	C
Silica Gel Tube Type B	480 mg	110 mg	6733021	C
Silica Gel Tube Type G	1100 mg	45 mg	6728851	C
Sampling Tube for Amines	300 mg	300 mg	8101271	C
Accessories and Spare Parts				
Aldehyde / Isocyanate Starter Set	Set required for sampling with the Aldehyde and / or Isocyanate Sampling Filter Set: consisting of 1 filter holder, connecting hose, adaptor, transport bottle.		6400872	C
Aldehyde Sampling Set	For sampling of aldehyde, including analysis (e.g. Formaldehyde, Acetaldehyde, Glutardialdehyde) in air		6400271	C
Isocyanate Sampling Filters	20 impregnated filter for 10 measurements and transport bottle		6400870	C
Isocyanate Sampling Set	For sampling of isocyanate, including analysis (e.g. TDI, HDI, MDI) in air.		6400131	C
Adaptor for sampling tubes (NIOSH)			6728639	C
Rubber sealing caps			CH16631	C
Aldehyde Sampling Filters	20 impregnated filter for 10 measurements and transport bottle		6400871	C

PORTABLE GAS DETECTION

PRODUCT	DESCRIPTION	PART NO	CATEGORY
GAS DETECTION KIT			
Simultaneous Test Sets - Hazardous Gas Screening System, for after Fires, Fumigation, Cladestine Lab Investigation and Civil Defence.			
 <p>The simultaneous test system offers different sets which are used with an adaptor (purchased separately) and a Dräger gas detector pump for the semi-quantitative determination of inorganic gases and organic vapours. Each test set is able to test for five different gases simultaneously. The simultaneous test sets provide on-site information to firefighter, HazMat teams, environmental agencies, First Responders, Police, Customs Authorities or any organisation with chemicals on site.</p>			
Simultaneous Test Set 1 (Inorganic Fumes)	Includes one each of the following tubes: Acid Gases (e.g. Hydrochloric Acid) Basic Gases (e.g. Ammonia) Carbon Monoxide Hydrocyanic Acid Nitrous Gases (e.g. Nitrogen Dioxide)	8101735	C
Simultaneous Test Set II (Inorganic Fumes)	Includes one each of the following tubes: Carbon Dioxide Chlorine Hydrogen Sulphide Phosgene Sulphur Dioxide	8101736	C
Simultaneous Test Set III (Organic Fumes)	Includes one each of the following tubes: Alcohols (e.g. Methanol) Aliphatic Hydrocarbons (e.g. n-Hexane) Aromatics (e.g. Toluene) Chlorinated Hydrocarbons (e.g. Perchloroethylene) Ketones (e.g. Acetone)	8101770	C
Simultaneous Test Indicator substances (Inorganic Fumes)	Includes one each of the following tubes: Carbon Monoxide Hydrocyanic Acid Hydrochloric Acid Nitrous Fumes Formaldehyde	8103170	C
Fumigation Test Set I For detection of gases used in Fumigation	Includes one each of the following tubes: Formaldehyde Phosphine Hydrogen Cyanide Methyl Bromide Ethylene Oxide	8103380	C

PORTABLE GAS DETECTION

PRODUCT	DESCRIPTION	PART NO	CATEGORY
CDS Test Set I For Chemical Warfare Gases	Includes one each of the following tubes: Hydrocyanic Acid Phosgene Lewesite N-Mustard S-Mustard	8103140	C
CDS Test Set V For Chemical Warfare Gases	Includes one each of the following tubes: Phosphoric Acid Esters Phosgene Cyanogen Chloride Chlorine Thioether	8103200	C
Training CDS Set I	Used in training	8103230	C
Training CDS Set V	Used in training	8103240	C
Clandestine Lab Kit	Includes one each of the following tubes: Iodine Hydrochloric Acid Ammonia Phosgene Phosphine	8103310	C

Accessories and Spare Parts



Place You Put Your Faith

Includes scoring element to open tubes

6400090

C

Adaptor (Simultaneous Test Sets)

Adaption Set Fumigation -magnetic	Fit up aid for 8103380	8318110	C
-----------------------------------	------------------------	---------	---

Note: Dräger Tubes in the Simultaneous Test Sets are specifically calibrated to be used as a set. It is not recommended to mix tubes from any of the sets or use standard tubes with the simultaneous test set adaptor.

PORTABLE GAS DETECTION

PRODUCT	DESCRIPTION	PART NO	CATEGORY
---------	-------------	---------	----------

AIR CURRENT DETECTION KIT



Dräger's Air Current Detector Kit is used to detect air currents and their direction in the following circumstances:

- * Checking fume hoods
- * Determining ventilation in mines
- * Detecting leaks in pipelines
- * Accessing a HazMat incident
- * Testing ventilating and air conditioning systems

Air Current Detector Kit



Complete with Rubber Ball Pump, Smoke Tubes, Tube Opener, Rubber Caps & User Instructions.

CH00216

C

Air Current Tubes (pack of 10)

DG

CH25301

C

Rubber Sealing Caps (pack of 10)

CH16631

C

Aspirater Bulb

CH12868

C

Place You Put Your Faith

AIR FLOW CHECK



Produces an environmentally harmless cloud of smoke allowing slight air currents and leaks to become visible.

Air Flow Check

Requires battery charger 8316993

6400761

C

Battery Charger

8316993

C

Air Flow Check Ampoules

3 ampoules per pack , Includes one nozzle

6400812

C

Battery Pack

6400817

C

In-car charger

6400803

C

PORTABLE GAS DETECTION

PRODUCT	DESCRIPTION	PART NO	CATEGORY
---------	-------------	---------	----------

DLE KIT



The Draeger Liquid Extraction Kit (DLE) is a contaminant detection method for analysis of liquid samples. The DLE kit is the most economical screening method available for fast, on-site determination of contaminants in industrial waste water, sewage treatment and hazardous material spills.

The measurement consists of 2 basic steps:

1. Extraction of the contaminant - During the extraction process, the contaminant in the liquid sample is transferred from the liquid phase into the gas phase.
2. Measurement of the contaminant - The extracted contaminant is measured from the headspace of the bottle by the Draeger tube.

DLE Kit

Including calibrated gas washing bottle, Accuro Multigas Detector, tube opener, measuring flask, thermometer, carbon pretubes, pH indicator, calculator, measuring report, handbook, instructions for use and measurement specification.

6400030

C

Place You Put Your Faith

PORTABLE GAS DETECTION

PRODUCT	DESCRIPTION	PART NO	CATEGORY
---------	-------------	---------	----------

GAS DETECTION KIT - DRÄGER AEROTEST

The Dräger AEROTEST 5000 is used to measure the quality of breathing air straight from either a low or a high pressure line.



Use the Dräger Aerotest 5000 to check the breathing air purity of a low pressure system (or high pressure system, with the corresponding accessories) in accordance with country-specific standards.

The system is automatic and extremely user-friendly.

Menu-driven measurement, downloading data and printing test certificates make testing and documenting with the Dräger Aerotest 5000 much easier.

Includes:

- * Carrying case
- * Connecting hose w. quick connect
- * Wall wart supply (240 VAC)
- * 6 x AA Alkaline batteries
- * USB stick Incl. PC software
- * Tube opener Dräger TO 7000
- * Stylus pen
- * Container for used Dräger-tubes
(No tubes or Oil Impactor Included)

Dräger Aerotest 5000

6401220

C

Pressure Reducer F 3002

Required for high pressure systems

3310794

C

PORTABLE GAS DETECTION

PRODUCT	DESCRIPTION	PART NO	CATEGORY
---------	-------------	---------	----------

The Draeger AEROTEST ALPHA is used to measure the quality of breathing air delivered by a low pressure system.



- 3 to 15 bar
- * carrying case
- * manifold with four tube holders
- * 1 x Barbed Nipple
- * 1 x Bubble test hose
- * packet of 5 sinter filters
- * stop watch
- * 1 Box of 10 Dräger-Tubes, Carbon Dioxide 100/a-P
- * 1 Box of 10 Dräger-Tubes, Carbon Monoxide 5/a-P
- * 1 Box of 10 Dräger-Tubes, Water Vapour 20/a-P
- * tube cutter
- * impactor adaptor
- * 1 box of 10 oil impactor

Aerotest ALPHA		6527150	C
Aerotest ALPHA	(without Dräger tubes)	6527149	C

The Draeger AEROTEST SIMULTAN HP is used to measure the quality of breathing air straight from a high pressure line e.g. compressor fill point.



- 8 to 300 bar
- * carrying case
- * manifold with four tube holders
- * 1 x Bubble test hose
- * packet of 5 sinter filters
- * high pressure reducer
- * stop watch
- * high pressure DIN adaptor
- * 1 Box of 10 Dräger-Tubes, Carbon Dioxide 100/a-P
- * 1 Box of 10 Dräger-Tubes, Carbon Monoxide 5/a-P
- * 1 Box of 10 Dräger-Tubes, Water Vapour 20/a-P
- * tube cutter
- * impactor adaptor
- * 1 box of 10 oil impactor

Aerotest Simultan HP		6525951	C
Aerotest Simultan HP	(without Dräger tubes)	6525937	C

The Draeger AEROTEST SIMULTAN CO2 is used for quantitative measurement of contaminants in carbonic acid supply systems.



- * carrying case
- * manifold with four tube holders
- * stop watch
- * seven packets of tubes
(H2O, CO, CO2, SO2, H2S, N)
- * tube opener

Aero test Simultan CO2		6526170	C
Aero test Simultan CO2	(without Dräger tubes)	6526743	C

Draeger Region South East Europe | Rev: 0 | Subject to modification! | www.draeger.com

PORTABLE GAS DETECTION

PRODUCT	DESCRIPTION	PART NO	CATEGORY
---------	-------------	---------	----------

Multi Test - Medical Gases

With the Draeger AEROTEST MEDICAL INT. contaminants low-pressure systems in compressed air, nitrous oxide, carbon dioxide and oxygen according to USP (United States Pharmacopaea) requirements can be measured.



- * carrying case
- * manifold with four tube holders
- * stop watch
- * six packets of tubes (Ammonia, H₂O, CO, CO₂, SO₂, H₂S, NO_x)
- * tube cutter
- * impactor adaptor / Oil Tubes
- * one packet of oil impactor devices

MultiTest - Medical Gases	With Oil Impactors	6520260	C
MultiTest - Medical Gases	With Oil Tubes	6535122	C
MultiTest - Medical Gases	(without Dräger tubes)	6527319	C

Aerotest - Navy

The Dräger AEROTEST NAVY is used to measure the quality of breathing air including O₂ straight from a high pressure line e.g. compressor fill point.



- * carrying case
- * manifold with four tube holders
- * stop watch
- * two high pressure DIN adaptors
- * five packets of tubes (H₂O, CO, CO₂, O₂, oil)
- * Accuro pump
- * tube cutter

Aero Test - NAVY		6525960	C
Aero Test - NAVY	(without Dräger tubes)	6525970	C

Accessories and Spare Parts

Carbon Dioxide 100a/P		6728521	C
Carbon Monoxide 5/a-P	DG	6728511	C
Oil 10/a-P		6728371	C
Oxygen 5%/C		8103261	C
Sulphur Dioxide 0.5/a		6728491	C
Water Vapour 5/a-P		6728531	C
Water Vapour 20/a-P		8103061	C
Hydrogen Sulphide 1/d		8101831	C
Oil Impactor	(Box of 10)	8103560	C



Tube Opener Dräger TO 7000

Impactor Adaptor		8103557	C
------------------	--	---------	---

PERSONAL PROTECTION EQUIPMENT

BREATHING APPARATUS CABE

PAS Lite / Accessories / Spare Parts	64
PSS 3000 / Lung Demand Valve	65
PSS 4000	66
PSS 5000	69
Bodyguard 7000 version / LDV / Complete Sets	70
PSS 7000 / Accessories / Lines / LDV	71
PAS Colt Hip Mounted Unit	78
PAS Micro	82

AIRLINE TROLLEYS AND BREATHING PROTECTION

Automatic Switch Over Valve (PAS ASV)	85
Airline Hoses	87
PAS AirPack	89
PAS Filter	92
PAS Reducer	94
PAS MAC	96

PERSONAL AIRLINE SYSTEMS

PAS X-plore	98
X-plore 9300	99
X-plore 9500	103
Bodyguard 1000 Personal Alert System (PASS)	104

ENTRY CONTROL BOARDS

PSS Merlin - Telemetry	107
Regis Entry Control Board	109

FULL FACE MASKS

Positive Pressure	110
Communication systems - Mask Communication	111

ESCAPE SETS

Saver CF	120
Saver PP	121
Dräger CF (N)	122

TEST EQUIPMENT

Testor	124
Questor 5000	125
Quastor 7000	126

PROTECTIVE CLOTHING

Cool Vest	128
Air Fed Chemical Protection Suits - CVA 0700 / SPC 3700	130
Splash Protection - Protec Plus / SPC 2400 / SPC 3800	137
Limited Use - CPS 5800 / CPS 5900	143
Reusable Gas Suit -	
CPS 6800 / CPS 6900 / CPS 7800 / CPS 7900	147
Gloves	174
Boots	176

HELMETS

HPS 3500	178
Accessories (inc. Goggles, Visors, Lamps) / Spare Parts	179
HPS 7000	180
Communication Systems - Helmet Communication	182

THERMAL IMAGING CAMERA

UCF 6000, 7000, 8000, 9000	186
----------------------------	-----

SELF RESCUERS

Dräger Oxy 3000 MKII & Accessories	187
Dräger Oxy 6000 MKII & Accessories	189
Dräger Oxy K Series & Accessories	191

CLOSED CIRCUIT BREATHING APPARATUS

PSS BG4 Plus / Face Masks	193
Anti-Mist	194
BG4 Kit & Test / Accessories	195

PERSONAL PROTECTIVE EQUIPMENT

PRODUCT	DESCRIPTION	PART NO	PACKAGING UNIT	CATEGORY
---------	-------------	---------	----------------	----------

BREATHING APPARATUS - CABE



Dräger PAS® Lite Compressed Air Breathing Apparatus for use in industrial applications where a simple, robust and easy to use breathing apparatus is required, the Dräger PAS® Lite Self-Contained Breathing Apparatus (SCBA) combines reliability with comfort and performance. Lightweight yet robust, this pneumatic gauge SCBA offers excellent service life as well as being easy to maintain.

Basic set consisting of:

- Basic set with Integrated Lung Demand Valve, Ruberised shoulder straps and webbing waistbelt - the waistpad is an option only
- Carbon composite antistatic space frame
- Moulded handles for easy carrying
- Pull sideways waistbelt adjustment
- Camlock rubberised cylinder strap
- Accommodates single steel and carbon composite cylinders
- Sizes in the range 4L 200 bar to 9L 300 bar
- Balanced 1st stage reducer for 200 bar or 300 bar cylinder
- EN 137:2006 Type 2 (Fire Fighting)
- Photo-luminescent pneumatic pressure gauge
- Pneumatic warning whistle at reducer

Basic Set				
PAS Lite - A	PAS Lite with integrated lung demand valve (LDV)	3357774	1	D
PAS Lite - Airline A	PAS Lite with integrated lung demand valve (LDV) and integrated Airline complete with an automatic switch over device	3358255	1	D
Complete Set				
Accessories and Spare Parts for PAS Series				
Dräger PAS ASV for PAS Lite - permanent fit	Permanent fit PAS ASV for use in conjunction with Dräger PAS Lite Breathing Apparatus and an external air supply	3358874	1	D
Dräger PAS ASV CPS for PAS Lite - permanent fit	Permanent fit ASOV for use in conjunction with Dräger PAS Lite Breathing Apparatus and an external air supply	3358850	1	D

PERSONAL PROTECTIVE EQUIPMENT

PRODUCT	DESCRIPTION	PART NO	PACKAGING UNIT	CATEGORY
---------	-------------	---------	----------------	----------



The Dräger PSS® 3000 is a new generation of high performing breathing apparatus for firefighters. Combining comfort with exceptional pneumatic performance, it is designed for applications where simplicity and ease of use are key essentials.

Basic set consisting of:

- Basic set with QRC, shoulder pads and waist pad
- Carbon composite antistatic space frame
- Moulded handles for easy carrying
- Pull sideways waistbelt adjustment
- Camlock rubberised cylinder strap
- Accommodates single steel and carbon composite cylinders
- Sizes in the range 4L 200 bar to 9L 300 bar
- Balanced 1st stage reducer for 200 bar or 300 bar cylinder
- EN 137:2006 Type 2 (Fire Fighting)
- Photo-luminescent pneumatic pressure gauge
- Pneumatic warning whistle integrated with gauge at chest

Gauge Version				
PSS3000 with gauge	Mask, LDV & Cylinder required for operation.	3357794	1	D
Complete Sets				
PSS 3000 fixed LDV DIN		3358906		D
PSS 3000 ChargAir DIN		3358657		D
PSS 3000	with Tx Gauge DIN	3360984		D
PSS 3000 fixed LDV	with Tx Gauge DIN	3360985		D
PSS 3000 CH	with TX Gauge DIN	3360986		D
PSS 3000	with TX Gauge & Bodyguard 1500 PASS DIN	3360987		D
PSS 3000 Fixed LDV	with TX Gauge & Bodyguard 1500 PASS DIN	3360988		D
PSS 3000 CH	with TX Gauge & Bodyguard 1500 PASS DIN	3360989		D
Lung Demand Valve				
Plus Lung Demand Valve	LDV with standard length hose	3338700	1	D
H2S Plus Lung Demand Valve	LDV with standard length hose with H2S resistant diaphragm	3338967	1	D
LDV anti tamper labels	The LDV Anti-Tamper label allows gives a clear visual indication if the LDV cover has been removed outside of the workshop environment, offering the wearer additional peace of mind and confidence in the product.	3360475	1	D

PERSONAL PROTECTIVE EQUIPMENT

PRODUCT	DESCRIPTION	PART NO	PACKAGING UNIT	CATEGORY
---------	-------------	---------	----------------	----------



The Dräger PSS® 4000 SCBA is a new generation high performance light weight breathing apparatus for the professional fire fighter. Combining advanced ergonomics with a wide range of configurable options the Dräger PSS® 4000 provides the user with comfort and versatility to meet the demands of first responders whenever breathing protection is required.

- Ergonomic carrying system
- Advanced harness choice
- Service friendly & easy to maintain
- Integrated and concealed hose routing
- Wide variety of system configurations and accessories
- Electronic Monitoring with the Dräger Bodyguard 1500 Tx Gauge

Utilising the established Dräger PSS® Pneumatics and cylinder strap design, the Dräger PSS® 4000 combines established technology, state-of-the-art materials and innovative thinking to create an SCBA for virtually any application. To allow the breathing apparatus to be tailored to the required application, the new Dräger PSS® 4000 utilises state-of-the-art harness materials. The Dräger PSS® 4000 utilises materials to withstand the high wear and tear that firefighters face daily, whilst providing an enhanced level of comfort and function. Incorporating hardwearing stainless steel buckles and long-life Aramid blend webbing, the PSS® 4000 is suitable for frequent use.

Dräger PSS® 4000				
PSS 4000 Pneumatic Gauge SCS		3363988	1	D
PSS 4000 Pneumatic Gauge TCS		3366863	1	D
PSS 4000 Fixed LDV Pneumatic Gauge SCS		3363989	1	D
PSS 4000 Fixed LDV Pneumatic Gauge TCS		3366864	1	D
PSS 4000 TX Gauge SCS		3363990	1	D
PSS 4000 TX Gauge TCS		3366865	1	D
PSS 4000 Fixed LDV TX Gauge SCS		3363991	1	D
PSS 4000 Fixed LDV TX Gauge TCS		3366866	1	D
PSS 4000 TX Gauge & Bodyguard 1500 SCS		3364018	1	D
PSS 4000 TX Gauge & Bodyguard 1500 TCS		3366867	1	D
PSS 4000 Fixed LDV TX Gauge & Bodyguard 1500 SCS		3364019	1	D
PSS 4000 Fixed LDV TX Gauge & Bodyguard 1500 TCS		3366868	1	D
PSS 4000 Charge Air Pneumatic Gauge SCS		3364020	1	D
PSS 4000 Charge Air Pneumatic Gauge TCS		3366870	1	D
PSS 4000 Charge Air Fixed LDV Pneumatic Gauge SCS		3364021	1	D
PSS 4000 Charge Air Fixed LDV Pneumatic Gauge TCS		3366871	1	D
PSS 4000 Charge Air TX Gauge SCS		3364022	1	D

PERSONAL PROTECTIVE EQUIPMENT

PRODUCT	DESCRIPTION	PART NO	PACKAGING UNIT	CATEGORY
Electronics				
TX Gauge Kit (Including Bodyguard 1500 Pass)		3360992		
TX Gauge Kit		3360139		
Bodyguard 1500 Pass (Button)		3360839		
Bodyguard 1500 Pass (Tally)		3360840		
FPS 7000 HUD receiver		3356555		
Battery (CR123A)		3356715		
PC Link Module-Incl PC Software		3356560		
Harness Pack PSS 4000		3364173		
Secondary Supply and Airline Accessories				
Y-Piece Twin QRC MP Hose Kit		3355848		
2nd Supply MP Combined Hose: Waist – Unsecured		3356530		
2nd Supply MP Combined Hose Backward: Waist – Secured		3358403		
2nd Supply MP Combined Hose Forward: Waist – Secured		3358406		
2nd MP Rescue Coupling Hose (QRC) Kit (female)		3358867		
2nd MP Male Decon' Hose Kit (male inlet)		3358869		
Buddy Breather Pouch		3358596		
Complimentary Products <i>Place You Put Your Faith</i>				
PSS® Rescue Hood		3354982		
RPS 3500		3356824		
Breathing Apparatus Set Hardshell Carrying Case (Orange)		3335412		
Breathing Apparatus Holdall Carry Bag		3356473		
Bodyguard 1000 - Button Version		3358684		
Bodyguard 1000 - Tally Version		3358685		
Bodyguard 1000 - Tally, Button Version		3359131		

PERSONAL PROTECTIVE EQUIPMENT

PRODUCT	DESCRIPTION	PART NO	PACKAGING UNIT	CATEGORY
General accessories				
Chest Strap		3339280		
LDV Holder (PI)		3357527		
LDV Holder (M45)		3357528		
LDV Holder (ESA / RD40)		3357526		
Lung Demand Valves (LDV)				
PSS LDV Short Hose Push In		3338700		
PSS LDV Short Hose Push In (H2S)		3338967		
As 3338700 but with polymer diaphragm for use in H2S environments				
PSS LDV Short Hose M45		3338706		
PSS LDV Short Hose M45 (H2S)		3338968		
As 3338706 but with polymer diaphragm for use in H2S environments				
PSS LDV Short Hose RD40		3350501		
PSS LDV Short Hose RD40 (H2S)		3338969		
As 3350501 but with polymer diaphragm for use in H2S environments				
PSS LDV RD40 1.75m (rescue only)		3350606		
PSS LDV Short Hose ESA		3351302		
PSS LDV Short Hose ESA (H2S)		3351333		
As 3351302 but with polymer diaphragm for use in H2S environments				

Place You Put Your Faith

PERSONAL PROTECTIVE EQUIPMENT

PRODUCT	DESCRIPTION	PART NO	PACKAGING UNIT	CATEGORY
---------	-------------	---------	----------------	----------

Dräger PSS® 5000

The Dräger PSS® 5000 SCBA is a new generation high performance breathing apparatus for the professional firefighter. Combining advanced ergonomics with a wide range of configurable options the Dräger PSS® 5000 provides the user with the comfort and versatility to meet the demands of first responders whenever breathing protection is required.

- Ergonomic carrying system
- Advanced harness choice
- Service friendly & easy to maintain
- Integrated and Versatile hose routing
- Wide variety of system configurations and accessories
- Electronic Monitoring with the Dräger Bodyguard® 7000

To allow the breathing apparatus to be tailored to the required application, the Dräger PSS® 5000 utilizes new state-of-the-art harness materials offered in a choice of 2 harness options.



The Dräger Standard (DS) harness is a cost effective option for everyday use, offering a high level of comfort and durability.

- Contoured/padded shoulder
- Rigid "Slide and Lock" Harness Connection
- Polyamide buckles
- Flame retardant polyester webbing



The Dräger Professional (DP) utilizes materials to withstand the high wear and tear. The DP is ideally suited to extended wear and frequent use. Incorporating:-

- Swivel & pivot waist belt for optimum wearer ergonomics
- hardwearing stainless steel buckles
- long-life Aramid blend webbing,

Gauge Version				
PSS 5000 DS with Gauge	Single cylinder strap, requires Plus LDV	3357858	1	D
PSS 5000 DS with Gauge	Universal cylinder strap, requires Plus LDV	3358338	1	D
PSS 5000 DS with Gauge & Cylinder Quick Connect	Single cylinder strap, requires Plus LDV	3358428	1	D
PSS 5000 DP with Gauge	Single cylinder strap, requires Plus LDV	3357845	1	D
PSS 5000 DP with Gauge	Universal cylinder strap, requires Plus LDV	3358333	1	D
PSS 5000 DP with Gauge & Cylinder Quick Connect	Single cylinder strap, requires Plus LDV	3358431	1	D
PSS 5000 DP with Gauge & Chargeair connection	Universal cylinder strap, requires Plus LDV	3359004	1	D

PERSONAL PROTECTIVE EQUIPMENT

PRODUCT	DESCRIPTION	PART NO	PACKAGING UNIT	CATEGORY
Bodyguard 7000 Version				
PSS 5000 DS with Bodyguard 7000 Tally	Single cylinder strap, requires Plus LDV	3358350	1	D
PSS 5000 DS with Bodyguard 7000 Tally	Universal cylinder strap, requires Plus LDV	3358352	1	D
PSS 5000 DS with Bodyguard 7000 Tally Quick Connect	QC set comes with single strap and a 300 bar quick connect cylinder adaptor. Requires Plus LDV	3358435	1	D
PSS 5000 DP with Bodyguard 7000 Tally	Single cylinder strap, requires Plus LDV	3358354	1	D
PSS 5000 DP with Bodyguard 7000 Tally	Universal cylinder strap, requires Plus LDV	3358356	1	D
PSS 5000 DP with Bodyguard 7000 Tally Quick Connect	QC set comes with single strap and a 300 bar quick connect cylinder adaptor. Requires Plus LDV	3358437	1	D
Lung Demand Valve				
Plus Lung Demand Valve	LDV with standard length hose	3338700	1	D
H2S Plus Lung Demand Valve	LDV with standard length hose with H2S resistant diaphragm	3338967	1	D
LDV anti tamper labels	The LDV Anti-Tamper label gives a clear visual indication if the LDV cover has been removed outside of the workshop environment, offering the wearer additional peace of mind and confidence in the product.	3360475	1	D

Place You Put Your Faith

PERSONAL PROTECTIVE EQUIPMENT

PRODUCT	DESCRIPTION	PART NO	PACKAGING UNIT	CATEGORY
---------	-------------	---------	----------------	----------

PSS® 7000



The PSS 7000 is the state of the art positive pressure breathing apparatus incorporating Dräger's latest ergonomic energy saving comfort design using standard cylinders.

- Unique carbon composite adjustable back plate
- New anti slip easy to clean harness
- 10 year repex pressure reducer overhaul
- patented hip belt that slides and swivels with the wearer
- shoulder waist padding
- auto positive pressure LDV with CEJN coupling
- integrated warning whistle with luminous gauge or Bodyguard 7000
- universal cylinder strap for all cylinders including 6.0 and 6.8 litre twins





Gauge Version				
PSS 7000 with Gauge	Single cylinder strap, requires Plus LDV	3355068	1	D
PSS 7000 with Gauge	Universal cylinder strap, requires Plus LDV	3355930	1	D
PSS 7000 with Gauge & Cylinder Quick Connect	Single cylinder strap, requires Plus LDV	3356542	1	D
Bodyguard 7000 Version				
PSS 7000 with Bodyguard 7000	Single cylinder strap, requires Plus LDV	3356551	1	D
PSS 7000 with Bodyguard 7000 tally	Single cylinder strap, requires Plus LDV	3356679	1	D
PSS 7000 with Bodyguard 7000	Universal cylinder strap, requires Plus LDV	3356552	1	D
PSS 7000 with Bodyguard 7000 tally	Universal cylinder strap, requires Plus LDV	3356680	1	D
PSS 7000 with Bodyguard 7000 Cylinder Quick Connect	Single cylinder strap, requires Plus LDV	3356553	1	D
PSS 7000 with Bodyguard 7000 tally Cylinder Quick Connect	Single cylinder strap, requires Plus LDV	3356825	1	D

Cylinder Quick Connect sets come with a 300 bar cylinder quick connect adaptor

PERSONAL PROTECTIVE EQUIPMENT

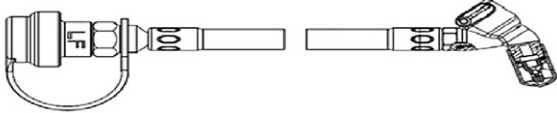
PRODUCT	DESCRIPTION	PART NO	PACKAGING UNIT	CATEGORY
Lung Demand Valve				
Plus Lung Demand Valve	LDV with standard length hose	3338700	1	D
H2S Plus Lung Demand Valve	LDV with standard length hose with H2S resistant diaphragm	3338967	1	D
LDV anti tamper labels	The LDV Anti-Tamper label gives a clear visual indication if the LDV cover has been removed outside of the workshop environment, offering the wearer additional peace of mind and confidence in the product.	3360475	1	D
Breathing Apparatus Accessories				
FPS 7000 HUD Transmitter Kit	Consisting of pressure module and HP manifold (allows upgrade from PSS 5000 or PSS 7000 with pneumatic gauge or Bodyguard II to FPS 7000 Heads-Up-Display) in mask display and power supply not Included.	3356882	1	D
AA battery pack	(set of 5 Alkaline batteries Included)	3356556	1	D
Bodyguard 7000 Upgrade Kit (Button) (Upgrade of PSS 5000 or 7000 with pneumatic gauge to PSS 5000 or 7000 with Bodyguard 7000, power supply not Included)	Consisting of Bodyguard 7000 (Tally) display module & pressure Module Including HP hose & pneumatic whistle.	3357098	1	D
Bodyguard 7000 Upgrade Kit (Tally) (Upgrade of PSS 5000 or 7000 with pneumatic gauge to PSS 5000 or 7000 with Bodyguard 7000, power supply not Included)	Consisting of Bodyguard 7000 (Button) display module & pressure Module Including HP hose & pneumatic whistle.	3357101	1	D
Dräger PSS® Safety Belt for PSS SCBA				
	The Dräger PSS Safety Belt increases wearer safety by securing the fire fighter in unstable environments or while working at height.			
	PSS Rescue belt upgrade kit for PSS 5000 only. EN approved only	3364199	1	D
	PSS Rescue belt upgrade kit for PSS 7000 only. EN approved only	3364200	1	D
Lanyard pouch Right	For PSS safety belt	3364194	1	D
Lanyard pouch left	For PSS safety belt	3364195	1	D
Lanyard	For PSS safety belt	3364196	1	D
Karabiner	For PSS safety belt	3364197	1	D

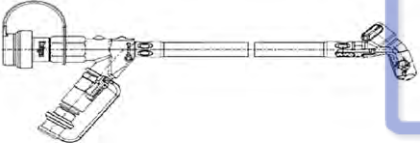
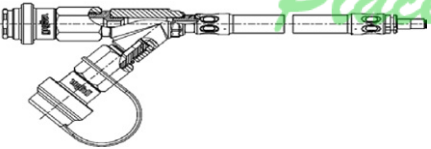
PERSONAL PROTECTIVE EQUIPMENT

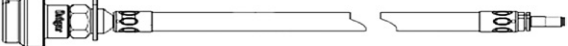
PRODUCT	DESCRIPTION	PART NO	PACKAGING UNIT	CATEGORY
BREATHING APPARATUS SECONDARY AND DECONTAMINATION LINES				
	470mm long – For PSS 5000/7000	3355748	1	D
	390mm long – For PAS Lite, PSS 3000	3358867	1	D
	900mm long – For PSS 5000/7000	3358506	1	D
	470mm long – For PSS 5000/7000	3355749	1	D
	390mm long – For PAS Lite, PSS 3000	3358869	1	D
	250mm long – For PSS 5000/7000	3358504	1	D
	300mm long	3356530	1	D
	870mm long – For PSS 7000	3355848	1	D
	880 mm (RH) – For PSS 5000/7000	3358340	1	D
	977 mm (LH) – For PSS 5000/7000	3358341	1	D

PERSONAL PROTECTIVE EQUIPMENT

PRODUCT	DESCRIPTION	PART NO	PACKAGING UNIT	CATEGORY	
	Rescue Coupling Hose, standard	470mm long – For PSS 5000/7000	3358503	1	D
	2nd MP combined connector hose (LF) - (secured)	250mm long – For PSS 5000/7000	3358406	1	D
	2nd MP combined connector hose (LF) - (secured)	250mm long – For PSS 5000/7000	3358403	1	D
	2nd MP combined connector hose (LF) - (secured)	300mm long – For PAS Lite, PSS 3000	3358868	1	D
	2nd MP combined connector hose (LF) - (unsecured)	For PAS Lite, PSS 3000	3358870	1	D
	2nd MP combined connector hose (inlet male) - (secured)	For PAS Lite, PSS 3000	3358872	1	D
MP hose identifier (Yellow)	The Medium Pressure Identifier allows easy location the medium pressure/2nd medium pressure hoses in difficult, smoke filled environments during rescue and extraction protocols. The MP Hose Identifier can be fitted to any medium pressure/2nd medium pressure hose (waist or shoulder mounted)	3360474	1	D	

PERSONAL PROTECTIVE EQUIPMENT

PRODUCT	DESCRIPTION	PART NO	PACKAGING UNIT	CATEGORY
LDV Holder (Push in)		3357527	1	D
Charging Adapter 300 bar Incl. Blanking Plug w Chain	For compressor changing line	3357198	1	D
Cylinder QC Adapter 300 bar		3357210	1	D
Cylinder Quick Connect Storage Blank 300 bar		3357197	1	D
FPS 7000 HUD In-Mask Display		3356555	1	D
PSS 7000 AA battery pack	Set of 5 batteries Included	3356556	1	D
PSS 7000 PC Link Module	Includes PC Link Software	3356560	1	D
PSS 7000 Personal ID Cards	Pack of 10	3356561	1	D
PSS 7000 NiMH Battery	For Merlin Modem Only	3358121	1	D
Lung Demand Valve				
Plus Lung Demand Valve	LDV with standard length hose	3338700	1	D
H2S Plus Lung Demand Valve	LDV with standard length hose with H2S resistant diaphragm	3338967	1	D
Plus Lung Demand Valve	LDV with long hose	3338701	1	D
LDV anti tamper labels	The LDV Anti-Tamper label gives a clear visual indication if the LDV cover has been removed outside of the workshop environment, offering the wearer additional peace of mind and confidence in the product.	3360475	1	D

Place Your Faith

PERSONAL PROTECTIVE EQUIPMENT



Professionally protected
Body protection, respiratory protected system and body cooling

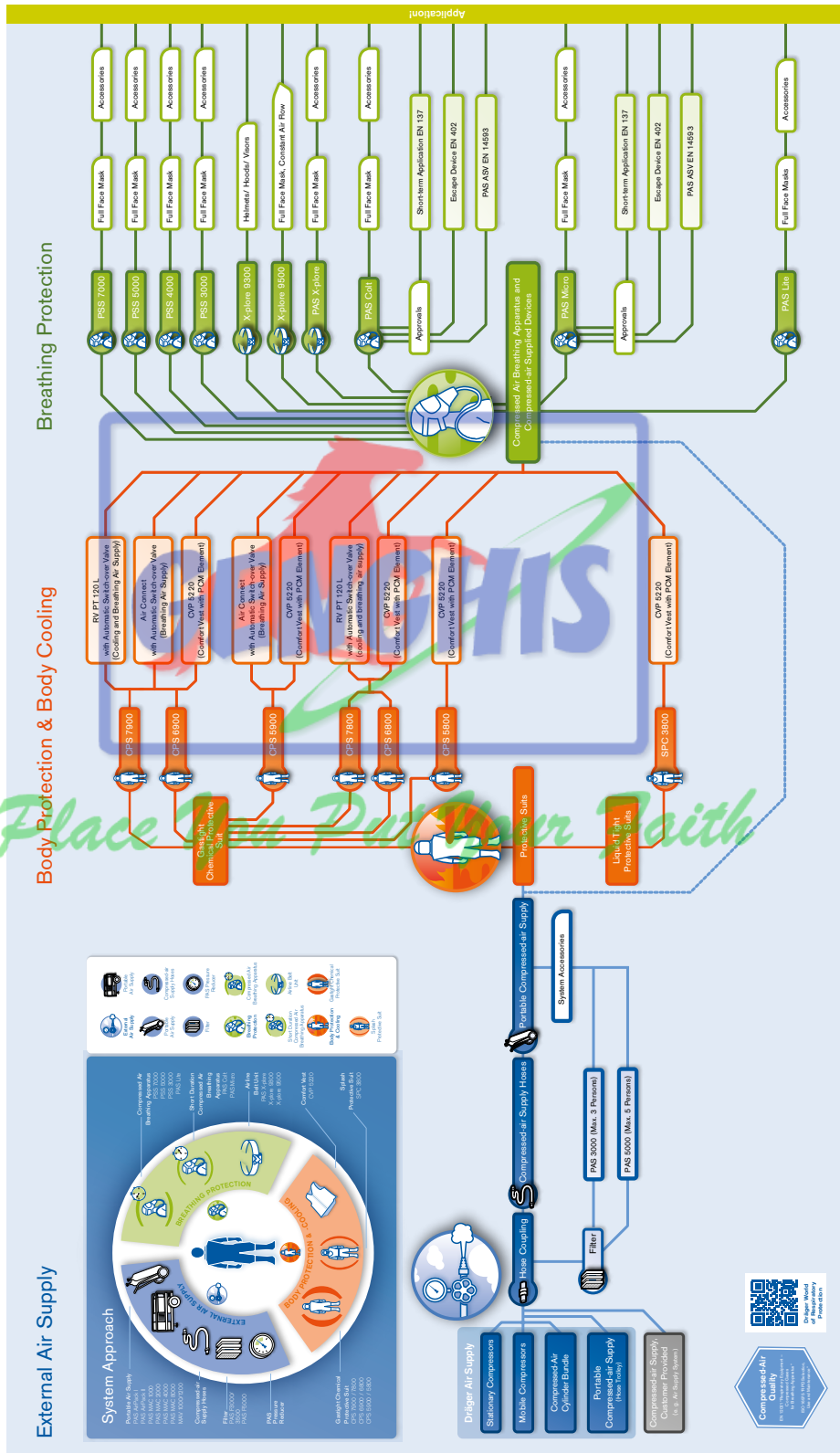

Dräger PAS[®] Colt Short Term Breathing Apparatus

Combining versatility, ease of use and the latest in breathing apparatus design, Dräger's PAS[®] Colt is among the most technologically advanced short duration and emergency escape units available.



PERSONAL PROTECTIVE EQUIPMENT

PRODUCT	DESCRIPTION	PART NO	PACKAGING UNIT	CATEGORY
---------	-------------	---------	----------------	----------

PAS COLT



PAS Colt 10, 15 and 20 minute breathing apparatus. A short duration breathing apparatus which is worn over the shoulder with the cylinder sitting on the hip. The material is durable and impervious to water, chemicals and oils. It can come with or without a lung demand valve and airline attachment. Versions that come with an LDV but no PAS ASV have the LDV integrated so it cannot be disconnected. The PAS ASV switches the air supply to the cylinder in case the airline supply pressure drops. All versions of the PAS Colt are suitable for use in explosive atmospheres (Zone 0) but are not approved for fire fighting use.

Webbing & Pneumatics						
	LDV Included	Gauge on Colt	Gauge on Cylinder	Airline Connection	PAS ASV	Cylinder & Mask to be quoted separately
Working/Entry - Warning Whistle at 55bar						
PAS Colt (3L / 200 bar ST)						3352634 1 D
PAS Colt (3L / 300 bar CC)						3352920 1 D
PAS Colt (2L / 300 bar CC)						3352635 1 D
PAS Colt (2L / 300 bar CC)						3360449 1 D
Working/Entry with Airline - Warning Whistle at 100bar						
PAS Colt (3L / 200 bar ST)						3358026 1 D
PAS Colt (3L / 300 bar CC)						3358027 1 D
PAS Colt (2L / 300 bar CC)						3358028 1 D
PAS Colt (3 L / 300 bar CC) (Hansen)						3356755 1 D
Escape						
PAS Colt (2L / 200 bar AL)						3352761 1 D
PAS Colt (3L / 200 bar ST)						3352744 1 D
PAS Colt (2L / 300 bar CC)						3352778 1 D
PAS Colt (2L / 200 bar AL)						3352626 1 D
PAS Colt (3L / 200 bar ST)						3352413 1 D
PAS Colt (2L / 300 bar CC)						3352627 1 D
PAS Colt (3 L / 200 bar ST) c/w airline (Hansen type coupling)						3354378 1 D

PERSONAL PROTECTIVE EQUIPMENT

PRODUCT	DESCRIPTION	PART NO	PACKAGING UNIT	CATEGORY
---------	-------------	---------	----------------	----------

PAS COLT

PAS Colt



Webbing & Pneumatics

	LDV Included	Gauge on Colt	Gauge on Cylinder	Airline Connection	PAS ASV	Cylinder & Mask to be quoted separately
Escape with Airline						
PAS Colt (3 L / 200 bar) c/w airline						3353354 1 D
PAS Colt (3 L / 200 bar) c/w airline						3353355 1 D
PAS Colt (3 L / 200 bar) c/w airline						3353356 1 D
PAS Colt (2 L / 200 bar) c/w airline						3358024 1 D
PAS Colt (3 L / 200 bar) c/w airline						3358023 1 D
PAS Colt (2 L / 300 bar CC) c/w airline						3358025 1 D
Airline Belt Manifold Only						
1. PAS Colt Airline Harness						3352942 1 D
Accessories						
Airline Belt Manifold		To fit to an existing Pas Colt				3352564 1 D
Airline Belt Manifold c/w WWU		To fit to an existing Pas Colt				3352565 1 D
PAS Colt leg strap						3353281 1 D
2. PAS carry bag						3354491 1 D
Face Masks						
3. FPS 7000 Medium			EPDM			R56200 1 D
3. FPS 7000 Medium			EPDM & Anti-Scratch			R57820 1 D
3. FPS 7000 Medium			Silicone			R56331 1 D
3. FPS 7000 Small			EPDM			R56249 1 D
3. FPS 7000 Large			EPDM			R56300 1 D
Lung Demand Valve						
4. Plus LDV Short Hose Push in			Standard			3338700 1 D
5. Plus LDV Short Hose Push in			For environments with H2S			3338967 1 D

PERSONAL PROTECTIVE EQUIPMENT

PRODUCT	DESCRIPTION	PART NO	PACKAGING UNIT	CATEGORY
---------	-------------	---------	----------------	----------

PAS COLT

PAS Colt



Cylinders without Integrated Valve for Entry Sets				
1. Cylinder (3 L / 200 bar ST) 15min	395x115, 4kg empty / 4.76kg full	3352684	1	D
1. Cylinder (3 L / 300 bar CC) 22.5min	439x115, 2.5kg empty / 3.54kg full	3352682	1	D
1. Cylinder (2 L / 300 bar CC) 15min	389x103, 1.9kg empty / 2.6kg full	3352683	1	D
Cylinders with Integrated Valve for Escape Sets				
1. Cylinder (3 L / 300 bar CC) 22.5min	439x115, 2.5kg empty / 3.54kg full	3352687	1	D
1. Cylinder (2 L / 300 bar CC) 15min	389x103, 1.9kg empty / 2.6kg full	3352688	1	D
1. Cylinder (2 L / 200 bar AL) 15min	395x102, 3kg empty / 3.51kg full	3352689	1	D
1. Cylinder (3 L / 200 bar ST) 15min	395x115, 4kg empty / 4.76kg full	3352690	1	D

Place You Put Your Faith

Cylinder durations are based on 40 litres per minute and are total duration not the working duration

ST - Steel

CC - Carbon Composite

AL - Aluminium

WWU - Warning whistle unit

Dräger PAS[®] Micro Short Term Breathing Apparatus

Combining versatility, ease of use and the latest in breathing apparatus design, Dräger's PAS[®] Micro is among the most technologically advanced short duration and emergency escape units available.

Robust carrying system

- Made from antistatic, highly flexible, robust material
- Machine washable
- Closed-pore pad: water, oil and chemical resistant as well as acid and alkaline resistant
- Stable form – even at extreme temperatures
- High resistance to wear and heat

Precise manometer

- (tested in accordance with EN 137)
- Positioned on the side of the body (hip-mounted): easily readable

Small, light compressed air cylinder

- No heavy burden during use

Connection for Airline

- For use in combination with an external air supply (air hose system or compressed air network) and optional automatic switch-over valve (ASV) between the external supply and the compressed air cylinder



PERSONAL PROTECTIVE EQUIPMENT

PRODUCT	DESCRIPTION	PART NO	PACKAGING UNIT	CATEGORY
---------	-------------	---------	----------------	----------

PAS MICRO



PAS Micro 10, 15 and 20 minute breathing apparatus. A short duration mini breathing apparatus which is worn on the back. The material is durable and impervious to water, chemicals and oils. It can come with or without a lung demand valve and airline attachment. Versions that come with an LDV but no PAS ASV have the LDV integrated so it cannot be disconnected. The PAS ASV switches the air supply to the cylinder in case the airline supply pressure drops. All versions of the PAS Micro are suitable for use in explosive atmospheres (Zone 0) but are not approved for fire fighting use.

	LDV Included	Gauge on Collar	Gauge on Cylinder	Airline Connection	PAS ASV		
Working/Entry - Warning Whistle 100bar							
PAS Micro						3352640	1 D
PAS Micro						3358032	1 D
Escape							
PAS Micro						3352924	1 D
PAS Micro						3352925	1 D
PAS Micro						3353357	1 D
PAS Micro						3358031	1 D



Accessories							
1. PAS Micro High Vis Vest						3356512	1 D
Face Masks							
2. FPS 7000 Medium			EPDM		R56200	1	D
2. FPS 7000 Medium			EPDM & Anti-Scratch		R57820	1	D
2. FPS 7000 Medium			Silicone		R56331	1	D
2. FPS 7000 Small			EPDM		R56249	1	D
2. FPS 7000 Large			EPDM		R56300	1	D

PERSONAL PROTECTIVE EQUIPMENT

PRODUCT	DESCRIPTION	PART NO	PACKAGING UNIT	CATEGORY
---------	-------------	---------	----------------	----------

PAS MICRO



Lung Demand Valve				
1. Plus LDV Short Hose Push in	Standard	3338700	1	D
2. Plus LDV Short Hose Push in	For environments with H2S	3338967	1	D
Cylinders without Integrated Valve for Entry Sets				
3. Cylinder (3 L / 200 bar ST) 15min	395x115, 4kg empty / 4.76kg full	3353813	1	D
3. Cylinder (3 L / 300 bar CC) 22.5min	439x115, 2.5kg empty / 3.54kg full	3353811	1	D
3. Cylinder (2 L / 300 bar CC) 15min	389x103, 1.9kg empty / 2.6kg full	3353810	1	D
Cylinders with Integrated Valve for Escape Sets				
3. Cylinder (3 L / 300 bar CC) 22.5min	439x115, 2.5kg empty / 3.54kg full	3353811	1	D
3. Cylinder (2 L / 300 bar CC) 15min	389x103, 1.9kg empty / 2.6kg full	3353810	1	D
3. Cylinder (2 L / 200 bar AL) 15min	395x102, 3kg empty / 3.51kg full	3353737	1	D
3. Cylinder (3 L / 200 bar ST) 15min	395x115, 4kg empty / 4.76kg full	3353813	1	D
Cylinder Covers				
3. Cylinder cover 2 L / 200 bar		3353089	1	D
3. Cylinder cover 3 L / 200 bar		3353090	1	D
3. Cylinder cover 2 L / 300 bar		3353088	1	D
3. Cylinder cover 3 L / 300 bar		3353091	1	D

Cylinder durations are based on 40 litres per minute and are total duration not the working duration

ST - Steel

CC - Carbon Composite

AL - Aluminium

Dräger PAS® ASV Airline Equipment

The Dräger Automatic Switch over Valve (PAS® ASV) enables the user to connect compressed air breathing apparatus to an external air supply, such as a factory ring main, and be safe in the knowledge that if the external supply were to fail, there would be a safe and uninterrupted transition to the wearer's back-up air supply.



ST-6185-2007

PERSONAL PROTECTIVE EQUIPMENT

PRODUCT	DESCRIPTION	PART NO	PACKAGING UNIT	CATEGORY
---------	-------------	---------	----------------	----------

AUTOMATIC SWITCH OVER VALVE (PAS ASV)

The Dräger Automatic Switch-Over Valve (Dräger PAS ASV) enables the user to connect compressed air breathing apparatus to an external air supply, such as a factory ring main, and be safe in the knowledge that if the external supply were to fail, there would be a safe and uninterrupted transition to the wearer's back-up air supply. During the switch-over operation the Dräger PAS ASV maintains positive pressure within the facemask at all times, ensuring the breathing apparatus wearer is provided with optimum protection throughout their wearing duration. All units, unless stated include a Dräger airline connector as standard. Also available fitted to the range of Dräger Breathing apparatus, see separate price lists for part numbers and details.



Current Draeger Breathing Apparatus				
1. PAS ASV – Colt Kit Permanent fit	For use with the PAS Colt.	3354140	1	D
1. PAS ASV – Colt Kit (Hansen) Permanent fit	For use with the PAS Colt, Includes a Hansen QRC airline connector.	3356749	1	D
2. PAS ASV – Micro Kit Permanent fit	For use with the PAS Micro.	3354141	1	D
PAS ASV – PAS Lite/PSS 3000 Permanent fit	For use with the PAS Lite and PSS 3000 Breathing Apparatus.	3358850	1	D
PAS ASV – PAS Lite/PSS 3000 Permanent fit- CPS	For use with the PAS Lite and PSS 3000. This unit is suitable for use with chemical protective suit ventilation systems.	3358874	1	D
3. PAS ASV – PSS 5000/7000 Quick fit	For use with PSS 5000 and PSS 7000	3355844	1	D
4. PAS ASV – PSS 5000/7000 Quick fit - CPS	For use with the PSS 5000 and PSS 7000. This unit is suitable for use with chemical protective suit ventilation systems.	3357007	1	D
PAS ASV – PSS 5000/7000 Permanent fit	For use with PSS 5000 and PSS 7000	3357618	1	D
PAS ASV – PSS 5000/7000 Permanent fit - CPS	For use with the PSS 5000 and PSS 7000. This unit is suitable for use with chemical protective suit ventilation systems.	3357733	1	D

PERSONAL PROTECTIVE EQUIPMENT

PRODUCT	DESCRIPTION	PART NO	PACKAGING UNIT	CATEGORY
Old Draeger Breathing Apparatus				
5. PAS ASV - Quick fit BA/CPS/QRC KIT	For use with the PSS 100, PSS 90, PA94 Plus, PA91 Plus, PSS 3000 and PAS Lite. This unit is suitable for use with chemical protective suit ventilation systems.	3354405	1	D
PAS ASV – CPS Kit Permanent fit unit	For use with the PSS 100, PSS 90, PA94 Plus, PA91 Plus, PSS 3000 and PAS Lite. This unit is suitable for use with chemical protective suit ventilation systems.	3354568	1	D
PAS ASV – Permanent BA Kit Permanent fit	For use with the PSS 100, PSS 90, PA94 Plus and PA91 Plus.	3354142	1	D
PAS ASV – Quick fit BA Kit	For use with the PSS 100, PSS 90, PA94 Plus, PA91 Plus, PSS 3000 and PAS Lite	3354244	1	D

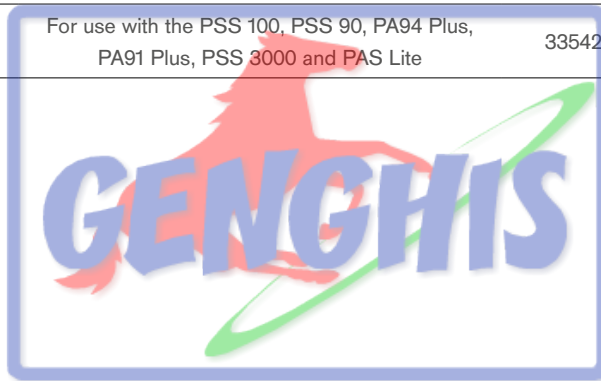

Place You Put Your Faith

PERSONAL PROTECTIVE EQUIPMENT

PRODUCT	DESCRIPTION	PART NO	PACKAGING UNIT	CATEGORY
---------	-------------	---------	----------------	----------

AIRLINE HOSES



Black Anti-static, chemical resistant				
1. 3m Airline		3352463	1	D
1. 5m Airline		AL01260	1	D
1. 10m Airline		AL01261	1	D
1. 20m Airline		AL01262	1	D
1. 25m Airline		3357409	1	D
1. 30m Airline		3352467	1	D
1. 45m Airline		AL01263	1	D
1. 50m Airline		3352468	1	D

Antistatic & Chemical Resistant CODAN Airline

Place You Put Your Faith

Dräger PAS® AirPack 1 Compressed Air Breathing Apparatus

Designed using leading technology and materials, Dräger's range of heavy-duty airline apparatus is ideal for use where an extended duration of breathing air is called for. Chemical tank cleaning, toxic spillages or certain tasks when working on offshore installations are all made easier and more comfortable when using the Dräger PAS® AirPack 1.



Anti-corrosion Polymeric Powder Coating

Pneumatic Arrangement

Hore Drum with Brake Mechanism

Extendable Hose

Twin Cylinder Support Straps

Trolley Frame with Two-wheeled
Fixed Angle

Dräger PAS® AirPack 2 Compressed Air Breathing Apparatus

Designed using leading technology and materials, Dräger's range of heavy-duty airline apparatus is ideal for use where an extended duration of breathing air is called for. Chemical tank cleaning, toxic spillages or certain tasks when working on offshore installations are all made easier and more comfortable when using the Dräger PAS® AirPack 2.



PERSONAL PROTECTIVE EQUIPMENT

PRODUCT	DESCRIPTION	PART NO	PACKAGING UNIT	CATEGORY
---------	-------------	---------	----------------	----------

PAS AIRPACK SERIES - AIRLINE TROLLEYS

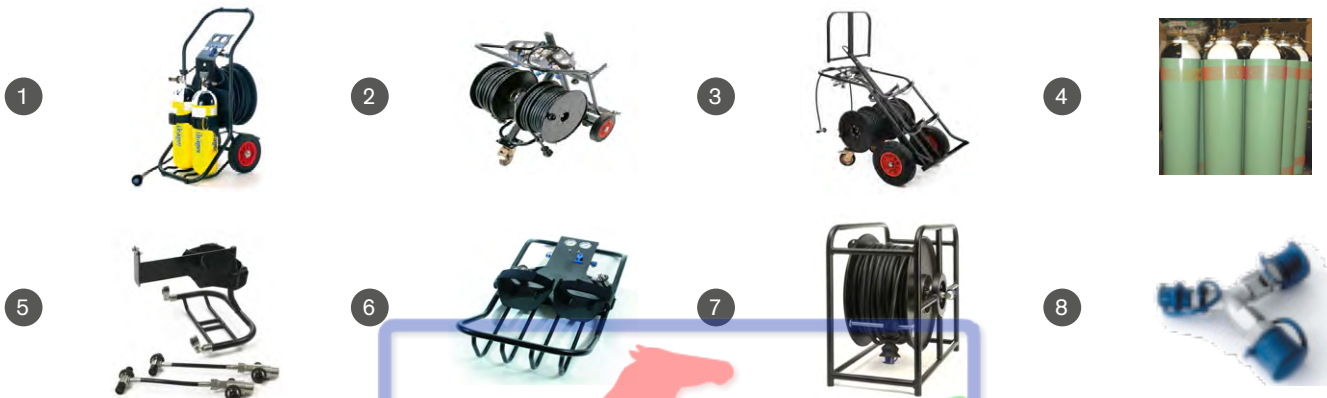

PAS AirPack One				
1. PAS Airpack 1	Includes: Pressure reducer, 50m antistatic hose reel & drum, vent valve, medium and high pressure gauge, 2 cylinder connections, cylinders can be hot swapped, rescue airline connection	3352228	1	D
PAS AirPack One	Same as above without the airline & reel	3353008	1	D
PAS AirPack Two				
PAS Airpack 2	1 person or 2 with Y Piece - 1 Pressure reducer, 1 50m hose reel	3352994	1	D
PAS AirPack Two	1 person or 2 with Y Piece - 1 Pressure reducer, 1 50m hose reel & lifting eye	3352995	1	D
2. PAS AirPack Two	2 person or 4 with Y Pieces - 2 Pressure reducer, 2 50m hose reel	3352276	1	D
3. PAS AirPack Two	2 person or 4 with Y Pieces - 2 Pressure reducer, 2 50m hose reel & lifting eye	3352236	1	D
Accessories and Spare Parts				
5. PAS Quad Pack	Allows the Pas Airpack 1 to utilise 4 cylinders at the same time	3353471	1	D
6. PAS Airpack 1 Carry Frame	Cylinder holder and Pneumatic Panel only	3352241	1	D
PAS Airpack 2 Updrade Kit	Upgrades the PAS Airpack 2 from 1/2 person to 3/4 person by adding all required parts	3358500	1	D
7. Stand Alone Hose Reel	50 metres of CODAN hose on a drum/reel with frame	3352239	1	D
8. Y piece	Allows a second person to work off the same hose reel/pressure reducer	R27945	1	D

Dräger PAS® Filter series Airline Equipment

PAS® Filters reliably clean air, e.g. from an existing high-pressure network, from liquid and solid particles, including oil vapour and smell. This not only means that you get breathing air which even exceeds the specifications of DIN EN 12021. You also save yourself the need of a separate breathing air line.



PERSONAL PROTECTIVE EQUIPMENT

PRODUCT	DESCRIPTION	PART NO	PACKAGING UNIT	CATEGORY
---------	-------------	---------	----------------	----------

PAS FILTER - BREATHING AIR FILTERS



PAS Filters reliably clean air, e.g. from an existing high-pressure network, from liquid and solid particles, including oil vapour and smell. save yourself the need of a separate breathing air line.

Key features of the Dräger PAS Filter Series:

- Wall mounted or portable
- Two connection options: for max. three (760 L/min) or max. five persons (1,080 L/min)
- Active carbon and particle filters for solid and liquid particles Incl. humidity, oil droplets and smells
- Optional pre-filter for large particles

PAS 3000 Series - 3 Outlets / 3 People				
Dräger PAS F3000	Wall mounted	3359915	1	D
Dräger PAS F3500	Wall mounted with pre-filter	3359921	1	D
Dräger PAS F3000 P	Portable	3359916	1	D
Dräger PAS F3500 P	Portable with pre-filter	3359922	1	D
PAS 5000 Series - 5 Outlets / 5 People				
Dräger PAS F5000	Wall mounted	3359923	1	D
Dräger PAS F5500 (with pre-filter)	Wall mounted with pre-filter	3359925	1	D
Dräger PAS F5000 Portable	Portable	3359924	1	D
Dräger PAS F5500 Port (w. pre-filter)	Portable with pre-filter	3359926	1	D
PAS 3000/5000 Series - Inlet Hose				
This is the hose that connects the PAS filter system to the customers compressor or workplace reticulated airline system				
PAS 3000 inlet hose connector 1/4" BSP	1 required per airline	10-320-5152	1	F
PAS 5000 inlet hose connector 3/8" BSP		10-320-5154	1	F
PAS 3/5000 inlet hose coupling 1/2" hose barb		10-320-2005		F
Hose connector for customers site	Customer to specify	POR	1	F
Braided blue inlet airline 12mm ID	per metre	19-958-1801	1	F
Please note that the client will need to provide the connector required for their site				
Replacement Filters				
Activated-carbon filter element	For PAS 3000/5000 Series	3359928	1	D
F3000/F3500 coalescing filter element		3359909	1	D
F3500 pre-filter element		3359929	1	D
F5000/F5500 coalescing filter element		3359932	1	D
F5500 pre-filter element		3359934	1	D

Replacement filters Include new O-rings

Dräger PAS Pressure Reducer

Dräger takes care of your breathing air so you can take care of yourself: the Dräger PAS Pressure Reducer.



The Dräger PAS airline range helps you deliver breathing air where you want it, when you need it. One part of this system is the new Dräger PAS Pressure Reducer, connecting your high pressure breathing air source to your airline breathing system.

The development of this product is based heavily upon Dräger's world renowned PSS range of breathing apparatus which is used by professional fire-fighters around the world. When used in combination with the Dräger's heavy duty airline (PAS) range of products the system is as flexible as possible, so that each element can be interchanged where necessary, allowing for many different sets of circumstances to be effectively and safely dealt with.

Key features of the Dräger PAS Pressure Reducer:

- G $\frac{3}{8}$ " inlet connector suitable for use with most 200 bar and 300 bar breathing air sources (an adaptor is available for connection to G $\frac{3}{8}$ " bullnose connections)
- High pressure primary gauge giving accurate indication of the input air pressure
- High pressure whistle giving warning that the input air source has fallen to a low level
- Medium pressure secondary gauge giving accurate indication of the pressure in the airline breathing system
- Dräger standard CEJN outlet connection, allowing for complete system integration with all Dräger PAS and PSS products
- Integrated relief / vent valve protecting the airline system from over pressurisation



Dräger PAS Pressure Reducer

PERSONAL PROTECTIVE EQUIPMENT

PRODUCT	DESCRIPTION	PART NO	PACKAGING UNIT	CATEGORY
---------	-------------	---------	----------------	----------

PAS PRESSURE REDUCER



PAS Pressure Reducer				
1. PAS Pressure Reducer - 1 Cylinder	Pressure reducer with one MP outlet and one HP cylinder connector	3357357	1	D
2. PAS Pneumatic Assembly - 1 Cylinder	Pressure reducer and mounting plate with one MP outlet and one HP hose for connection to HP cylinder	3355841	1	D
2. PAS pneumatic assembly - 2 Cylinders	Pressure reducer and mounting plate with one MP outlet and two HP hose for connection to HP cylinders	3358800	1	D

Place You Put Your Faith

Dräger PAS® MAC Series Airline Equipment

Providing continuous breathing quality air to safety professionals in the harshest of environments, these Mobile Breathing Air Compressors meet the needs of single or multiple users over long durations. Available in electric- or diesel-driven versions, each of the four models is fully compatible with Dräger compressed air and airline breathing equipment.



Place You Put Your Faith



D-0762-2010

PERSONAL PROTECTIVE EQUIPMENT

PRODUCT	DESCRIPTION	PART NO	PACKAGING UNIT	CATEGORY
---------	-------------	---------	----------------	----------

PAS MAC MOBILE BREATHING AIR COMPRESSOR SYSTEM

The PAS MAC provides continuous breathing quality air for single or multiple users over long durations. Available in electric or diesel driven versions, each model is fully compatible with Dräger compressed air and airline breathing equipment. The Product line Includes two electric driven models with 185 to 425 L/MIN and two diesel driven models, which provide the user with 710 to 1710 L/Min of breathing air. The electrically driven units can be supplied in ATEX versions (Zone 1).

The diesel driven compressors are fitted with spark arrestors as standard to protect the air intake and membrane dryers to ensure the quality of the air. On all diesel engine driven units a fail-safe system is fitted as standard. In the event of a failure, it sounds an alarm and automatically switches to an onboard high pressure reserve system, allowing time for users to move to a place of safety.

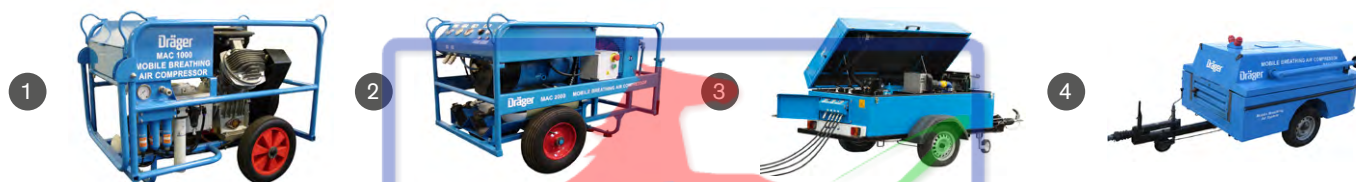

Dräger PAS MAC1000 (electric)	Single Phase 230V. For 1 user producing 185 l/min	3358223	1	D
Dräger PAS MAC1000 (electric) ATEX		3360710	1	D
Dräger PAS MAC2000 (electric)	Three phase 400V. For up to 2 users producing 510 l/min	3358224	1	D
Dräger PAS MAC2000 (electric) ATEX	Three phase 400V. For up to 2 users producing 510 l/min with escape back-up cylinders	3360711	1	D
Dräger PAS MAC2000 (electric) ATEX	Three phase 400V. For up to 2 users producing 510 l/min without escape back-up cylinders	3360712	1	D
Dräger PAS MAC4000 (diesel)	For up to 4 users producing 710 l/min Incl. membrane dryer	3358226	1	D
Dräger PAS MAC4000 (diesel)	For up to 4 users producing 710 l/min Incl. pressure swing dryer	3358227	1	D
Dräger PAS MAC8000 (diesel)	For up to 8 users producing 1710 l/min Incl. membrane dryer	3358229	1	D
Dräger PAS MAC8000 (diesel)	For up to 8 users producing 1710 l/min Incl. pressure swing dryer	3358230	1	D
Accessories				
4 man distribution panel		3358796	1	D
4 man distribution panel (alarmed)		3358799	1	D
3/4" distribution hose 15 m long		3358797	1	D
1/2" distribution hose 30 m long		3358794	1	D

PERSONAL PROTECTIVE EQUIPMENT

Dräger X-plore® 9000 and PAS X-plore® Airline breathing equipment

The new Dräger X-plore® 9000 series is designed for light duty industrial applications and provides comfortable and reliable respiratory protection. Thanks to such features as the patented safe-flow reducer and auto-test function, wearers can enjoy more operating convenience, safety and flexibility.



Range comes with
Safe-flow and Auto-test
Ensures correct airflow –
no need for pre-testing by user

**Protected flow
adjust mechanism**
Provides additional airflow to
the wearer for improved comfort

**Filter connection for
X-plore® 9500* facemask version**
For improved safety
during entry and escape

* Approval pending



Simple and easy connection
Compatible to standard Dräger
professional facemasks or
X-plore® 8000 headpieces

**Approved for the
latest versions**
EN14594 or EN14593
(WWU as standard)

**Range of input coupling
options to suit customer needs**
Dräger CEJN (96 series)
as standard options,
other options available

PERSONAL PROTECTIVE EQUIPMENT

PRODUCT	DESCRIPTION	PART NO	PACKAGING UNIT	CATEGORY
---------	-------------	---------	----------------	----------

PAS X-PLORE AIRLINE SYSTEM

Designed for use with a lung demand valve & positive pressure face mask. This variant uses 400-1200 l/min air at 5.0 to 10 bar. Ideal when a high level of protection is required



PAS X-plore				
1. PAS X-plore Airline Belt Manifold*	Comes with low pressure whistle warning	3363584	1	D
2. Plus Lung Demand Valve (LDV)	Standard length	3338700	1	D
3. FPS 7000 Face Mask EPDM PC Medium		R56200	1	D
*Waistbelt, LDV & Face mask must be ordered separately.				
Waistbelts				



4. Standard Waistbelt Medium	up to 1280mm / 50"	3363680	1	D
4. Standard Waistbelt Long	up to 1780mm / 70"	3363682	1	D
5. Decontamination waistbelt Medium	up to 1280mm / 50"	3363681	1	D
5. Decontamination waistbelt Long	up to 1780mm / 70"	3363683	1	D
6. Leather waistbelt Medium	up to 1220mm / 48"	3363461	1	D
6. Leather waistbelt Long	up to 1420mm / 56"	3363462	1	D

PERSONAL PROTECTIVE EQUIPMENT

PRODUCT	DESCRIPTION	PART NO	PACKAGING UNIT	CATEGORY
---------	-------------	---------	----------------	----------

X-PLORE 9300 AIRLINE SYSTEM

Designed for use with a hose and various constant flow Hoods, Helmets and Visors. This variant uses 200-1200 l/min air at 3.0 to 10 bar



1. X-plore 9300 Airline Belt Manifold*	Belt manifold	3363587	1	D
Waistbelt, breathing hose & hood/helmet/visor must be ordered separately.				
Waistbelts				
2. Standard Waistbelt Medium	up to 1280mm / 50"	3363680	1	D
2. Standard Waistbelt Long	up to 1780mm / 70"	3363682	1	D
3. Decontamination waistbelt Medium	up to 1280mm / 50"	3363681	1	D
3. Decontamination waistbelt Long	up to 1780mm / 70"	3363683	1	D
4. Leather waistbelt Medium	up to 1220mm / 48"	3363461	1	D
4. Leather waistbelt Long	up to 1420mm / 56"	3363462	1	D

Headpieces & hoses on next pages

Place You Put Your Faith

PERSONAL PROTECTIVE EQUIPMENT

PRODUCT	DESCRIPTION	PART NO	PACKAGING UNIT	CATEGORY
---------	-------------	---------	----------------	----------

Hoods & Hoses

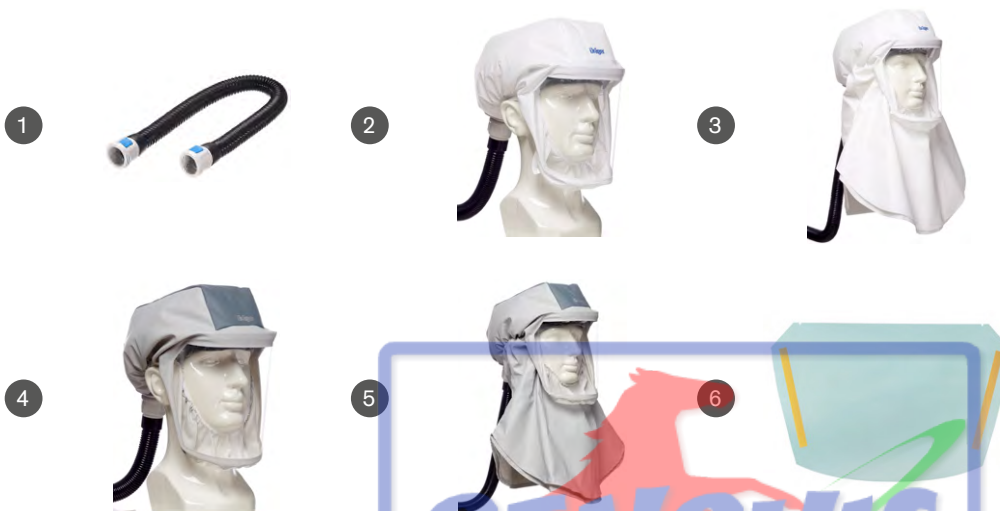

1. Standard breathing hose		R59620	1 / box	A
1. Flexible breathing hose	For hoods only	R59600	1 / box	A
2. Standard hood short (S/M)		R59800	1 / box	A
2. Standard hood short (L/XL)	For irregular use or as a disposable option.	R59810	1 / box	A
3. Standard hood long (S/M)	L/XL is the standard size.	R59820	1 / box	A
3. Standard hood long (L/XL)		R59830	1 / box	A
4. Premium hood short (S/M)		R59840	1 / box	A
4. Premium hood short (L/XL)	For regular use.	R59850	1 / box	A
5. Premium hood long (S/M)	L/XL is the standard size.	R59860	1 / box	A
5. Premium hood long (L/XL)		R59870	1 / box	A
6. Tear off visor protectors	For hoods only	R59863	10 / box	A

Spare Parts - Hoods

Hood Hose O-Ring		R59631	10 / box	H
Sweatband for Standard hood		R59826	10 / box	H
Sweatband for Premium hood		R59862	10 / box	H

PERSONAL PROTECTIVE EQUIPMENT

PRODUCT	DESCRIPTION	PART NO	PACKAGING UNIT	CATEGORY
---------	-------------	---------	----------------	----------

Helmets & Visors



1. Standard hose		R59640	1 / box	A
1. Flexible hose		R59650	1 / box	A
2. Helmet with visor, black		R58325	1 / box	A
3. Helmet with visor, white	Pivoting polycarbonate visor	R59910	1 / box	A
4. Protective Softshell visor		R59900	1 / box	A
5. Tear of visor protectors	For helmets & visors only	R58328	10 / box	A
6. Hearing protector set	for helmets only	R58329	1 / box	A

Spare Parts - Helmets

Hose O-Ring	Helmet & Visor	R59632	10 / box	H
Polycarbonate Visor	Impact Resistant	R58331	1 / box	H
Acetate Visor	Chemical resistant	R58332	1 / box	H
Face Seal	Material around chin	R58333	1 / box	H
Head Harness	Plastic internal harness	R58334	1 / box	H
Sweatband		R58330	10 / box	H

Spare Parts - Visor

Hose O-Ring	Helmet & Visor	R59632	10 / box	H
Head cover	Material over head	R59903	1 / box	H
Sweatband		R59904	10 / box	H
Polycarbonate Visor	Impact Resistant	R59901	1 / box	H
Face seal	Material around chin	R59902	1 / box	H

PERSONAL PROTECTIVE EQUIPMENT

PRODUCT	DESCRIPTION	PART NO	PACKAGING UNIT	CATEGORY
Welding Helmet				
				
1. Standard hose	for Helmets and Visors	R59640	1 / box	A
2. Flexible hose		R59650	1 / box	A
3. Welding Hose cover	Spark proof cover for hose	R59660	1 / box	A
4. Welding visor	with ADF 5-13	R59940	1 / box	A
Spare Parts - Welding Helmet				
Protective plate, inner	Spare parts	R59942	1 / box	H
Protective plate, outer	Spare parts	R59943	1 / box	H
ADF 5-13 for X-plore	Spare parts	R59944	1 / box	H
Head cover	Spare parts	R59927	1 / box	H

Place You Put Your Faith

PERSONAL PROTECTIVE EQUIPMENT

PRODUCT	DESCRIPTION	PART NO	PACKAGING UNIT	CATEGORY
---------	-------------	---------	----------------	----------

X-PLORE 9500 AIRLINE SYSTEM

X-plore 9500



Designed for use with a breathing hose and normal pressure face mask from our X-plore 6000 or FPS 7000 mask range. This variant uses 350-1200 l/min air at 3.0 to 10 bar.

Q2 2019

1		2			
1. X-plore 9500 Airline Belt Manifold*		Comes with low pressure whistle warning	TBA	1	D
2. Breathing Hose		Standard Length	TBA	1	D
2. Breathing Hose		Long	TBA	1	D

*Waistbelt, Hose & RD 40 Face mask must be ordered separately.

Waistbelts

4		5		6	
2. Standard Waistbelt Medium		up to 1280mm / 50"	3363680	1	D
2. Standard Waistbelt Long		up to 1780mm / 70"	3363682	1	D
3. Decontamination waistbelt Medium		up to 1280mm / 50"	3363681	1	D
3. Decontamination waistbelt Long		up to 1780mm / 70"	3363683	1	D
4. Leather waistbelt Medium		up to 1220mm / 48"	3363461	1	D
4. Leather waistbelt Long		up to 1420mm / 56"	3363462	1	D

Place You Put Your Faith

PERSONAL PROTECTIVE EQUIPMENT

PRODUCT	DESCRIPTION	PART NO	PACKAGING UNIT	CATEGORY
---------	-------------	---------	----------------	----------

DRÄGER BODYGUARD® 1000 PERSONAL ALERT SAFETY SYSTEM (PASS)





Dräger Bodyguard® 1000
Personal Alert Safety System (PASS)

Tough yet lightweight, the Dräger Bodyguard® 1000 is the newest addition to the Dräger Bodyguard® family of PASS devices.

Designed to protect life by alerting the team when a wearer becomes motionless or distressed, the Dräger Bodyguard® 1000 emits clear and distinctive signals and alarms to ensure quick and effective recognition, even in the worst environmental conditions.

Bodyguard 1000 (Button Version)		3358684	1	D
Bodyguard 1000 (Tally Version)		3358685	1	D
Bodyguard 1000 (Tally Version)	Two button switch off	3359131	1	D
Spare Parts				
Rubber Cover		3359332	1	D
Kit Crocodile Clip		3359333	1	D
Wireform Bracket		3359334	1	D
Seal (Battery Cover)		3359335	1	D
Battery Cover		3359336	1	D
Button Head Screw		3338367	10	D
Tally Key		3359337	1	D
Battery		3356715	1	D

PERSONAL PROTECTIVE EQUIPMENT

PRODUCT	DESCRIPTION	PART NO	PACKAGING UNIT	CATEGORY
Accessories and Spares for Breathing Apparatus				
	Breathing Apparatus Hard-shell Carrying Case	3335412	1	D
	UK Caba Wall Box Storage Cabinet (polycarbonate) Suitable for all SCBA and cylinder combinations	3310260	1	D
	Breathing Apparatus Storage Cabinet (stainless steel) Suitable for all SCBA and cylinder combinations	3358827	1	D
Bodyguard Software Kit CD and Cable		3351342	1	D
T piece for 6.0 - 6.8 ltr twin pack (Use IL Cylinder Valves)		3337660	1	D
RPS 3500 Rescue pack	The Dräger RPS3500 Rescue Pack System is designed for use by rescue teams, allowing fire fighters to supply air to trapped colleagues or members of the public in hazardous atmospheres.	3356824	1	D
Rescue hood	Can be used with RPS 3500 rescue kit or SCBA	3354982	1	D
Reflective pack PSS 5000 and 7000	The Reflective Pack for the PSS 5000 and PSS 7000 Series contains a cylinder strap, 2 pull forward straps and 4 hose loops with fire retardant reflective striping. The reflective striping allows easy identification and orientation of a wearer in dark/smoke filled environments, giving increased user safety and confidence.	3360476	1	D

PERSONAL PROTECTIVE EQUIPMENT

PRODUCT	DESCRIPTION	PART NO	PACKAGING UNIT	CATEGORY
Grab handles for PSS 5000	The Grab Handle for the PSS 5000 Series gives a clear "grab" point for a rescuer when extracting a user in distress. The Grab Handle sits across the shoulders of the wearer when not in use, but when "grabbed" extends out, giving the rescuer additional leverage.	3360480	1	D
Valve protection kit	The Valve Guide for the PSS 5000 offers protection to the cylinder valve during certain operational movements e.g. confined space entry and large impact forces to the bottom of the SCBA. Note only for PSS 5000 SCBA	3360481	1	D



Place You Put Your Faith

PERSONAL PROTECTIVE EQUIPMENT

PRODUCT	DESCRIPTION	PART NO	PACKAGING UNIT	CATEGORY
---------	-------------	---------	----------------	----------

ENTRY CONTROL BOARDS



The PSS Merlin is the state of the art telemetry system to monitor the current status of a BA wearer's breathing equipment.

Merlin allows Entry control officer to

- Monitor remaining cylinder pressure
- Monitor TTW (Time To Whistle)
- Monitor Time of Whistle
- Monitor BA wearer's ambient temperature
- Monitor elapsed time
- Receive DSU and ADSU signals
- Receive voluntary withdrawal signal
- Instigate individual or collective evacuation alarms

PSS Merlin - Telemetry

PSS Merlin 460MHz Complete		3362093	1	D
----------------------------	--	---------	---	---

The PSS Merlin is the state of the art telemetry system to monitor the current status of a BA wearer's breathing equipment.



Merlin allows Entry control officer to

- Monitor remaining cylinder pressure
- Monitor TTW (Time To Whistle)
- Monitor Time of Whistle
- Monitor BA wearer's ambient temperature
- Monitor elapsed time
- Receive DSU and ADSU signals
- Receive voluntary withdrawal signal
- Instigate individual or collective evacuation alarms

PSS Merlin Software and PC Modem

PSS Merlin PC Modem (Incl. Software)		3362093	1	D
PSS Merlin PC Modem Tablet Adaptor	Fixation of modem to Xplore tablets only	3360295	1	D

PERSONAL PROTECTIVE EQUIPMENT

PRODUCT	DESCRIPTION	PART NO	PACKAGING UNIT	CATEGORY
Radio Components				
PSS Merlin Modem Kit 450 - 470 Mhz	For PSS5000/7000 only	3362093	1	D
Repeater No.1 Assembly (450-470 MHz)		3362093	1	D
Repeater No.2 Assembly (450-470 MHz)		3362093	1	D
Merlin Accessories				
Merlin IR Service Interface Cable		3354303	1	D
Merlin / Bodyguard Datalog Cable		3354304	1	D
External Antenna & Cable		3354788	1	D
External Antenna Adaptor (N to BNC)		3355189	1	D
Protective Cover ECB		3351812	1	D
Universal Power Supply		3351804	1	D
ECB Charging Adaptor		3351819	1	D
ECB Vehicle Charging Kit (Quick Release)		3354349	1	D
4 Way Charging Adaptor	Repeater batteries	3351815	1	D
In-Cab charger PSS Modem (Quick Release)	For PSS5000/7000 only	3351681	1	D
Vehical Charging Kit ECB		3351810	1	D
Chinagraph Pencils (Pack of 12)		3351237	1	D
RFID Tallies (5 pcs.)	For PSS Merlin PC Modem	3360838	1	D
BG7000 NiMH 4-Way charger		3357885	1	D

PERSONAL PROTECTIVE EQUIPMENT

PRODUCT	DESCRIPTION	PART NO	PACKAGING UNIT	CATEGORY
---------	-------------	---------	----------------	----------

REGIS ENTRY CONTROL BOARD



The new Dräger REGIS® 300 is a handy and robust control board for monitoring the status of team members wearing breathing apparatus during an intervention. It provides a simple display of individual entry times and allows the entry control officer to set automatic intermediate alarms after expiry of predefined times.

- Illuminated stopwatch display
- Coloured name tags
- Robust
- Automatic alarms at set intervals
- Acoustic and visual alarms

Regis Entry Control Board				
Regis 300 Entry Control Board		R55950	1	D
Regis 500 Entry Control Board	With built-in signal transmitter	R54993	1	D
Accessories				
Name tags - Red	Set of 10 with carabiner hook and stickers	R54532	1	D
Name tags - Blue	Set of 10 with carabiner hook and stickers	R54533	1	D
External Signal Generator	Extend signal transmission	R54534	1	D

Place You Put Your Faith

PERSONAL PROTECTIVE EQUIPMENT

PRODUCT	DESCRIPTION	PART NO	PACKAGING UNIT	CATEGORY
---------	-------------	---------	----------------	----------

FULL FACE MASKS



Positive Pressure Masks				
1	FPS 7000 (All FPS 7000 series masks are available with anti scratch, anti fog coatings)			
2	Panorama Nova EPDM (Ethylene-Propylen-Dien-Mixture)			
3	Panorama Nova Silicone			
	Panorama Nova Mask EPDM	With push in connection	R52972	1 D
	Panorama Nova Mask Silicone	With push in connection	R53070	1 D
	FPS 7000 Mask EPDM Small	With push in connection	R56249	1 D
	FPS 7000 Mask EPDM Medium	With push in connection	R56200	1 D
	FPS 7000 Mask EPDM Medium with Hair Net	With push in connection	R56423	1 D
	FPS 7000 Mask EPDM Large	With push in connection	R56300	1 D
	FPS 7000 Mask SILICONE Medium	With push in connection	R56331	1 D
	FPS 7000 Mask EPDM Medium with anti-scratch visor	With push in connection	R57820	1 D
Negative Pressure Masks for Canisters				
	Panorama Nova Mask EPDM RA	Polycarbonate visor	R52850	1 D
	Panorama Nova Mask Silicone RA	Polycarbonate visor	R52855	1 D
	FPS7000 Mask EPDM Medium R/A	FPS 7130 With Screw in cannister connection. Anti fog visor coating	R56305	1 D
	FPS7000 Mask SILICONE Medium R/A	FPS 71110 With Screw in cannister connection.	R56332	1 D

PERSONAL PROTECTIVE EQUIPMENT

PRODUCT	DESCRIPTION	PART NO	PACKAGING UNIT	CATEGORY
---------	-------------	---------	----------------	----------

Com-Control 400



The Dräger C-C400 is an easy to operate push-to-talk button which offers an easy voice transfer in all situations. The large surface of the Dräger C-C400 makes it the first choice, for operation in all cases even when wearing the device under protective clothing. The Dräger C-C400 allows the direct connection of a headset or mask communication to the radio unit.

The C-C400 is extremely stable, robust and waterproof to resist all operational conditions. Depending on the radio it can be ATEX approved to be used in potentially explosive environments. A belt clip is included in the delivery. The Dräger C-C400 is also available with a "Mushroom PTT" to be used under a CPS. The Mushroom PTT can be retrofitted as well by a certified service workshop.

Com-Control 440



The Dräger C-C440 is an easy to operate push-to-talk button which simplifies the communication via the tactical radio.

The large push-to-talk button of the Dräger C-C440 makes it the first choice for operations when wearing the device under protective clothing (e.g. chemical protection suit).

The 4 pole Nexus adaptor allows a flexible connection of a headset or mask communication to the radio unit.

The C-C440 is extremely stable, robust and waterproof (MIL STD 810G and IP67) to resist all operational conditions. Depending on the radio, the unit can be ATEX approved for usage in potentially explosive environments. Order information and radio compatibilities shall be taken from the attached table.

Com-Control 500



The Dräger C-C500 can be combined with any type of Dräger headset. Thanks to the integrated microphone and speaker, the device can also be used without the upper unit (headset). The two large push-to-talk buttons allow an easy voice transfer, even when wearing the device under protective clothing. The C-C500 is extremely stable, robust and waterproof.

Depending on the radio it can be ATEX approved for use in potentially explosive environments.

The Dräger control units can be connected to over 400 different radios. Please use the order-code from the following table.

For Com-Control units for radios that you cannot find in the table please contact Dräger.

Com-Control 550



The Dräger C-C550 includes both an integrated microphone and speaker, which gives a flexibility of use as the device can be used with headset but also without a connected headset. It eases the use of the tactical radio significantly. The two large push-to-talk buttons allow an easy voice transfer, even when wearing the device under protective clothing.

The C-C550 is extremely stable, robust and waterproof (MIL STD 810G and IP67) to resist all operational conditions. Depending on the radio, the unit can be ATEX approved for usage in potentially explosive environments. For Com-Control units for radios that you cannot find in the table please contact Dräger.

For part numbers and pricing please see the 'Communication Systems' folder in 'Sales info from Marketing' or contact the relevant product manager

PERSONAL PROTECTIVE EQUIPMENT

PRODUCT	DESCRIPTION	PART NO	PACKAGING UNIT	CATEGORY
---------	-------------	---------	----------------	----------



The FPS Com 5000 is the successor of the FPS Coms Plus and features many design and functional improvements

- 20% louder voice amplifier than the FPS Com Plus
- Digital noise reduction filters out background noise and acoustic feedback
- Compatible with 350+ models of radio via external PTT
- Coms integrated PTT option
- "NEW" Bluetooth connectivity eliminate cables and intrinsic safety concerns
- "NEW" BG4 mask compatibility
- Simple and quick "click lock" module fitment and removal eliminates the need for tools
- No requirement to leak test mask upon fitment
- Auto shut off if no speech is detected (after 4 mins) conserves battery life
- IECEX and IP67 certified
- Improved sealing lines for battery compartment prevents water ingress

New generation FPS Coms - FPS 5000 Coms Units				
FPS-COM 5000 <u>without</u> mask:	MATRIX REQUIRED	R62700	1	D
FPS-COM 5000 with Positive Pressure mask	MATRIX REQUIRED	R62702	1	D
FPS-COM 5000 with Normal Pressure mask	MATRIX REQUIRED	R62701	1	D
FPS-COM 5000 with RP mask	MATRIX REQUIRED	R62703	1	D

Place You Put Your Faith

The FPS Com 7000 is the premium communication system for emergency responders and industry users and features many unique functions



- Hands free team communication, full duplex communication
- Team communication upto 100mtr range using integrated short range radio
- 10 team members can be grouped together, with the requirement for only one tactical radio to communicate to entry control
- 20% louder voice amplifier than the FPS Com Plus
- Digital noise reduction filters out background noise and acoustic feedback
- Compatible with 350+ models of radio via external PTT
- Coms integrated PTT option
- "NEW" Bluetooth connectivity eliminate cables and intrinsic safety concerns
- Simple and quick "click lock" module fitment and removal eliminates the need for tools
- No requirement to leak test mask upon fitment
- Auto shut off if no speech is detected (after 10 mins) conserves battery life
- IECEX and IP67 certified
- Improved sealing lines for battery compartment prevents water ingress

FPS 7000 Coms Units				
FPS-COM 7000 <u>without</u> mask:		R61100	1	D
FPS-COM 5000 w/ Positive Pressure mask		R61300	1	D
FPS-COM 5000 w/ Normal Pressure mask		R61350	1	D

PERSONAL PROTECTIVE EQUIPMENT

PRODUCT	DESCRIPTION	PART NO	PACKAGING UNIT	CATEGORY
---------	-------------	---------	----------------	----------

COMMUNICATION SYSTEMS - MASK COMMUNICATION

MS COM

A durable and easily mounted communication unit especially designed for Dräger full face masks. The speaker positioned in the temple area and the microphone positioned in the exhalation area enable an optimal communication by all dräger com-control-units to the radio.

Speaker: One speaker

Compatibility: Dräger Com-Control 400/440 500/550

Connector: Quick release plug (4 pole)

Remarks: Bracket is needed

ATEX approved*:

MS COM*	coiled cable	R35085	1	D
MS COM	coiled cable	R35025	1	D

MS COM Boom

A durable and easily mounted communication unit especially designed for Dräger full face masks. The speaker positioned in the temple area and the microphone positioned in the exhalation area enable an optimal communication by all dräger com-control-units to the radio. Easily adapted with a clip-on-system. only The bracket has to be mounted to the mask before.

Two speakers for all helmets with bone conductive microphone

Speaker: Two

Compatibility: Dräger Com-Control 400/440 500/550

Connector: Quick release plug (4 pole)

ATEX approved*:

MS-COM Boom FP*	straight, flash-over proof cable	R60918	1	D
-----------------	----------------------------------	--------	---	---

Accessories

Mounting brackets for adaption to masks

Bracket	For the assembly onto the Panorama Nova full face mask with metal frame	R35063	1	D
Bracket MS-COM	For the assembly onto the FPS 7000 full face mask	R56846	1	D

Mask caps

Protective cap for Panorama Nova P		R55086	1	D
Protective cap for Panorama Nova RA		R55088	1	D
Cap for FPS 7000 P/RA MS-COM		R56821	1	D
Cap for FPS 7000 RP MS-COM		R56981	1	D

PERSONAL PROTECTIVE EQUIPMENT

PRODUCT	DESCRIPTION	PART NO	PACKAGING UNIT	CATEGORY
---------	-------------	---------	----------------	----------

Noise-COM

The Dräger Noise-COM combines classical ear protection with a headset fitting almost any muff type hearing protection. Fits comfortably in the protection of the Dräger HPS 3100 and because of the quick assembly and disassembly the Noise-COM can be stored separately from the hearing protection, e.g. with the radio. In contrast to the in-ear-systems this headset can be used by several people without any hygiene issues.

Speaker: One
 Microphone: Boom microphone
 Compatibility: Dräger Com-Control 400/440 500550
 cable: Coiled cable
 ATEX approved*:



Noise-COM*	coiled cable	R60923	1	D
Noise-COM	coiled cable	R60939	1	D

This communication unit is available with an integrated PTT for several radios. This version can be connected with the individual radio without an external ptt. Order-codes are available at Dräger. Not ATEX approved!

TMS-COM

The Dräger TMS-COM is a comfortable and sensitive throat microphone that can be adapted to any Dräger control unit. This system can be used in high-noise environments and under protective suits. The flexible and washable neck band can be ordered as a spare part.

Speaker: One
 Microphone: Throat microphone
 Compatibility: Dräger Com-Control 400/440 500/550
 Connector: Quick release plug (4 pole)
 Cable: Coiled cable
 ATEX approved*:

Place You Put Your Faith



TMS-COM*	coiled cable	R35026	1	D
TMS-COM	coiled cable	R60920	1	D

E-COM

The Dräger E-COM is a personal speaker unit, which can be used for surveillance, incident command and police tasks. It is very small and can be adapted to either ears. The voice sensitive microphone offers good speech transmission with all Dräger control units. Not ATEX approved.

Speaker: One
 Compatibility: Dräger Com-Control 400/440 500/550
 Connector: Quick release plug (4 pole)
 Cable: Coiled cable



E-COM	coiled cable	R60913	1	D
-------	--------------	--------	---	---

This communication unit is available with an integrated PTT for several radios. This version can be connected with the individual radio without an external ptt. Order-codes are available at Dräger. Not ATEX approved!

PERSONAL PROTECTIVE EQUIPMENT

PRODUCT	DESCRIPTION	PART NO	PACKAGING UNIT	CATEGORY
---------	-------------	---------	----------------	----------

MP-H COM

The Multi-purpose-headset mounts into most helmets types and The microphone offers a good speech transmission with all Dräger control units

Speaker: One
 Compatibility: Dräger Com-Control 400/440 500/550
 Connector: Quick release plug (4 pole)
 Cable: Coiled cable



MP-H COM	coiled cable	R35036	1	D
Dräger MP-H COM EX	coiled cable	R35037	1	D
TMS-COM*	coiled cable	R35026	1	D
TMS-COM	coiled cable	R60920	1	D

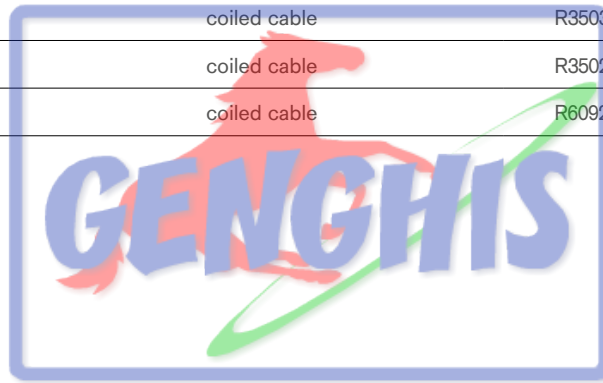

Place You Put Your Faith

PERSONAL PROTECTIVE EQUIPMENT

PRODUCT	DESCRIPTION	PART NO	PACKAGING UNIT	CATEGORY
---------	-------------	---------	----------------	----------



Hard plastic storage box for FPS 7000 mask room for mask and a filter.

- Box can be worn over the shoulder, stacked on top of each other, wall mounted or worn on the waist.

Accessories Full Face Mask				
FPS 7000 mask box		R56380	1	D
Kit waist belt attachment	Wear the mask box around the waist	R56883	1	D
Wall holder	Stainless steel bracket gives the ability to hang the mask box on the wall	R56882	1	D
Mask box I	Hard plastic storage box for Panorama Nova Mask	R53680	1	D
Mask box II	Hard plastic storage box for Panorama Nova Mask, smaller size than mask box I	R54610	1	D
Mask bag (Protex)	Dräger Protex mask bag	R54939	1	D
Spectacle frame kit	For Panorama Nova mask only	R51548	1	D
Spectacle frame kit	For FPS 7000 mask only	R56230	1	D



Available in either a gel, liquid or spray form, Dräger's ANTI-MIST agent for mask visors.

Anti - Mist				
ANTI-MIST fluid - 50 ml bottle	For NON coated visors	R52550	1	D
ANTI-MIST gel bottle 50 ml bottle	For NON coated visors	R52560	1	D
Klar-pilot comfort ANTI MIST spray	For coated visors Marked PCas or PCaf	R56542	1	D
Drying cabinet for breathing masks MTS 6	Drying capacity for 36 masks, also available for 24 or 12 masks, price on request	6573052	1	D

Dräger Saver CF Compressed Air Escape

The Dräger Saver CF constant flow Emergency Escape Breathing Apparatus allows safe, effective and uncomplicated escape from hazardous environments. Simple to put on and featuring practically automatic operation, this hood-based, positive-pressure breathing device can be used with minimal training.



Dräger Saver PP Compressed Air Escape

The Saver PP positive pressure Emergency Escape Breathing Apparatus allows safe, effective and uncomplicated escape from hazardous environments, even if H₂S is present. Simple to put on and featuring automatic operation, this positive-pressure breathing device features an integrated full-face mask and can be used in conjunction with other safety equipment such as ear protectors or helmets.



PERSONAL PROTECTIVE EQUIPMENT



Dräger Saver Series
 – Independent of ambient air
 – Escape duration 15 minutes or less

Saver CF (constant flow) with hood		Saver PP (positive pressure) with face mask	
Features – Simple and easy to use – Minimal training – Use with beard & glasses	Approvals – EN 1146:2005 – SOLAS / MED – ISO 23269-1:2008 – ISO 23269-3 / 4:2013	Features – High protection factor – Use with hard hat – Only for trained personnel	Approvals – EN 402 – SOLAS / MED
Non-ATEX applications		Non-ATEX applications	
10 Minutes Saver CF10 Soft pack 3359724	15 Minutes Saver CF15 Soft pack 3359735 Saver CF15 SE Soft pack for use in corrosive environments 3359742 Saver CF15 CC Soft pack / Cylinder option for lighter weight 3360789	10 Minutes Saver PP10 Soft pack 3359746 Saver PP10 A Soft pack / Secondary airline supply 3359754	10 Minutes Saver PP10 HC Hard case 3359791 Saver PP10 A HC Hard case / Secondary airline supply 3359799
15 Minutes Saver CF15 Soft pack 3359735 Saver CF15 SE Soft pack for use in corrosive environments 3359742 Saver CF15 HC Hard case 3359743 Saver CF15 SE HC Hard case for use in concrete environments / Anti-static 3359744 Saver CF15 SE HC Hard case / Special Beaufite for use in corrosive environments 3359744	15 Minutes Saver PP15 Soft pack 3359747 Saver PP15 A Soft pack / Secondary airline supply 3359755	15 Minutes Saver PP15 Soft pack / Anti-static 3359749 Saver PP15 A Soft pack / Anti-static / Secondary airline supply 3359757 Saver PP15 HC Hard case 3359792 Saver PP15 A HC Hard case / Secondary airline supply 3359790	15 Minutes Saver PP15 HC Hard case 3359792 Saver PP15 A HC Hard case / Secondary airline supply 3359790

Place Your PPE Here

Dräger: Technology for Life®

www.draeger.com

PERSONAL PROTECTIVE EQUIPMENT

PRODUCT	DESCRIPTION	PART NO	PACKAGING UNIT	CATEGORY
---------	-------------	---------	----------------	----------

COMPRESSED AIR ESCAPE SETS

Saver CF Escape Sets

The Saver CF is a compressed air emergency escape device (EEBD) that is used to provide safe air for escape. The CF, which is the hooded version, is the most common option due to the ease of donning in an emergency. The SE version of hood is intended for engine rooms of ships where ozone can cause the standard elastic neck seal to perish.

Maintenance - Although Draeger recommend an annual function check, there is no mandatory maintenance required apart from the 5 year cylinder hydrotest and the 10 year pressure reducer overhaul.



Soft Bag Constant Flow Variants - Hood

1. Saver CF 10 Escape Set	10 minute aluminium cylinder	3363824	1	C
2. Saver CF 10 Escape Set AS	10 minute aluminium cylinder + antistatic bag	3364313	1	C
3. Saver CF 15 Escape Set	15 minute steel cylinder	3363826	1	C
3. Saver CF 15 Escape Set SE	15 minute steel cylinder + ozone resistant hood	3363820	1	C
3. Saver CF 15 Escape Set CC	15 minute carbon composite cylinder	3360789	1	C
4. Saver CF 15 Escape Set AS	15 minute steel cylinder + antistatic bag	3364314	1	C
4. Saver CF 15 Escape Set AS SE	15 minute steel cylinder + antistatic bag + ozone resistant hood	3364315	1	C

Hard Case Constant Flow Variants - Hood

5. Saver CF 10 Escape Set HC	10 minute aluminium cylinder	3359739	1	C
5. Saver CF 15 Escape Set HC	15 minute steel cylinder	3359740	1	C
5. Saver CF 15 Escape Set HC SE	15 minute steel cylinder + ozone resistant hood	3359744	1	C

HC - Hard Case

AS - Antistatic

AC - Airline Connection

SE - Appropriate for harsh marine environments

CC - Carbon Composite

H2S - Hydrogen Sulphide Resistant

PERSONAL PROTECTIVE EQUIPMENT

PRODUCT	DESCRIPTION	PART NO	PACKAGING UNIT	CATEGORY
---------	-------------	---------	----------------	----------

COMPRESSED AIR ESCAPE SETS

Saver Escape Sets

The Saver PP is a compressed air emergency escape device (EEBD) that is used to provide safe air for escape. The PP is comes with a full face mask and lung demand valve.

Maintenance - Although Dräger recommend an annual function check, there is no mandatory maintenance required apart from the 5 year cylinder hydrotest and the 10 year pressure reducer overhaul.



Soft Bag Positive Pressure Variants - Mask

1. Saver PP10	10 minute aluminium cylinder	3363823	1	C
2. Saver PP10 AS	10 minute aluminium cylinder + antistatic bag	3364791	1	C
Saver PP10 AC	10 minute aluminium cylinder + airline connection	3364789	1	C
3. Saver PP10 AS AC	10 minute aluminium cylinder + antistatic bag + airline connection	3364790	1	C
4. Saver PP15	15 minute steel cylinder	3363825	1	C
2. Saver PP15 AS	15 minute steel cylinder + antistatic bag	3363821	1	C
Saver PP15 AC	15 minute steel + airline connection	3364311	1	C
Saver PP15 AS AC	15 minute steel cylinder + antistatic bag + airline connection	3364310	1	C
3. Saver PP15 AS H2S	15 minute steel cylinder + antistatic bag + H2S Resistant	3366859	1	C
3. Saver PP15 CC AS H2S	15 minute carbon composite cylinder + antistatic bag + H2S resistant	3366858	1	C
5. Saver PP15 CC AS H2S AC	15 minute carbon composite cylinder + antistatic bag + H2S resistant + airline connection	3366854	1	C

Hard Case Positive Pressure Variants - Mask

Saver PP10 HC	10 minute aluminium cylinder	R45005	1	C
Saver PP10 HC AC	10 minute aluminium cylinder + airline connection	R45005	1	C
Saver PP15 HC	15 minute steel cylinder	R45004	1	C
Saver PP15 HC AC	15 minute steel cylinder + airline connection	R45004	1	C

HC - Hard Case

AS - Antistatic

AC - Airline Connection

SE - Appropriate for harsh marine environments

CC - Carbon Composite

H2S - Hydrogen Sulphide Resistant

Dräger Region South East Europe | Rev: 0 | Subject to modification! | www.draeger.com

Place You Put Your Faith

PORTABLE
GAS DETECTION

PERSONAL
PROTECTION
EQUIPMENT

DRUG & ALCOHOL
DETECTION

MASKS & FILTERS

FIRE & GAS
DETECTION
SYSTEMS

ENGINEERED
SOLUTIONS

SERVICE,
TRAINING & RENTAL

DIVING
TECHNOLOGY

PERSONAL PROTECTIVE EQUIPMENT

PRODUCT	DESCRIPTION	PART NO	PACKAGING UNIT	CATEGORY
---------	-------------	---------	----------------	----------

EMERGENCY ESCAPE BREATHING DEVICE (EEBD) – DRÄGER SAVER CF (N)

Complete unit contained in an easy-to-don carrying bag for escape from hazardous environments.

Medical check-up in accordance with G 26 not required.

- Tested according to NIOSH
- ABS and SOLAS approvals

DRÄGER SAVER CF (N)

Complete unit comprising:

- Fast easy don hood
- Reliable design
- No mandatory routine service for 10 years
- Cylinder with special valve: activates automatically when opening the bag
- Standard charging connector G 5/8" at the valve, chargeable without any special tools or adapters
- Charging level indicator can read from the outside of the bag

Product Options:

The new Dräger Saver (N) series with one carry system option (orange vinyl bag) for high visibility and ease of ordering with 5, 10, 15 minute options. As standard all products provided with automatic activation for improved wearer confidence and safety.

Dräger Saver CF15 (N)	(Discharged 33 64 929) Operation period: 15 minutes. Equipped with: Charged aluminium cylinder 24 CU ft, hoop wrapped	4042057	1
Dräger Saver CF10 (N)	(Discharged 33 64 930) Operation period: 10 minutes. Equipped with: Charged aluminium cylinder 3000psi, 15 CU ft	4042056	1
Dräger Saver CF5 (N)	(Discharged 33 64 931) Operation period: 5 minutes. Equipped with: Charged aluminium cylinder 3000psi, 9CU ft	4042055	1

Spare compressed-air Cylinders			
Dräger Saver CF15 (N)		3363541	1
Dräger Saver CF10 (N)		3363540	1
Dräger Saver CF5 (N)		3363539	1
Accessories			
Saver CF15 (N) Bag Assembly		3362405	1
Saver CF10 (N) Bag Assembly		3362393	1
Saver CF5 (N) Bag Assembly		3392381	1
Storage Case Saver CF10 and 15 (N)		4055041	1
Storage Case Saver CF5 (N)		4055042	1
Wall Mount Kit (to attached storage case to wall)		4055000	1
Saver waistbelt		3350396	1
Security tab		3350388	1

Dräger Region South East Europe | Rev: 0 | Subject to modification! | www.draeger.com

Place Your Faith

PORTABLE
GAS DETECTION

PERSONAL
PROTECTION
EQUIPMENT

DRUG & ALCOHOL
DETECTION

MASKS & FILTERS

FIRE & GAS
DETECTION
SYSTEMS

ENGINEERED
SOLUTIONS

SERVICE,
TRAINING & RENTAL

DIVING
TECHNOLOGY

PERSONAL PROTECTIVE EQUIPMENT

PRODUCT	DESCRIPTION	PART NO	PACKAGING UNIT	CATEGORY
---------	-------------	---------	----------------	----------



Accessories					
1. Cylinder for Saver CF 10	Aluminium 2L, 200 bar	3350255	1	D	
1. Cylinder for Saver CF 15	Steel 3L, 200 bar	3350256	1	D	
1. Cylinder for Saver CF 15	Carbon composite 3L, 200 bar	3361587	1	D	
2. Saver waistbelt		3350396	1	D	
3. Anti-tamper seal		3350388	5	D	
Wall bracket (for hard case versions)		3360516	1	D	
4. EEBD Carry Case		3350424	1	D	
Wall mounting kit for EEBD carry case		3350431	1	D	
5. Wall Mount Storage Cabinet		3351823	1	D	

Place You Put Your Faith

PERSONAL PROTECTIVE EQUIPMENT

PRODUCT	DESCRIPTION	PART NO	PACKAGING UNIT	CATEGORY
---------	-------------	---------	----------------	----------

TEST EQUIPMENT



Ready for use following attachment to a compressed air supply, Dräger's compact table top Testor is suitable for CABA, masks, and gas suits.

- Gel Face II test head with knuckle head connection
- Low pressure gauge
- Medium pressure gauge
- Electronic stop-watch with audible signal
- Injector pump
- Pneumatic control switches, for generation of positive or negative pressures

Testor				
Testor 2500	Basic test unit & IFU no PC recording	R62950	1	D
Testor 3500	Basic test unit & IFU, USB cable and Dräger protector software	R62970	1	D
Upgrade kit Testor 2100 - Testor 3100	Upgrades post 2005 model Testor 2100 only	AG02650	1	D
Accessories and Spare Parts				
Workbench fixture	For securing the Testor 2500/3500 test device to a work bench	R62968	1	D
Shut of Valve	For isolating the medium pressure supply to the Test bench	AG02382	1	D
C-Clamp	for securing the Testor 2100/3100 test device to a work bench	R50809	1	D
Medium Pressure Hose	For connecting the test device to a stationary compressed-air pipeline NW7, 1	R46542	1	D
Positive pressure valve stopper		R53349	1	D
Positive pressure sealing stopper		R53345	1	D
Negative pressure sealing stopper		R53344	1	D
Adaptor plug into round thread		R50028	1	D

PERSONAL PROTECTIVE EQUIPMENT

PRODUCT	DESCRIPTION	PART NO	PACKAGING UNIT	CATEGORY
---------	-------------	---------	----------------	----------

DRÄGER QUAESTOR



All Static and dynamic Tests of the Dräger Quaestor 5000 take place semi-automatically as a sophisticated combination of personal handling and automated control during the test sequence. The newly developed software supports the user with intuitive user guidance.

With the Dräger Quaestor 5000 it is possible to test the following components:

- Full Face Masks
- Chemical protection Suits (Accessories necessary)
- Airline Breathing Equipment
- Compressed air breathing apparatus

Available options for further Testing:

- Closed circuit breathing apparatus
- Safety valves of pressure reducer

DRÄGER Quaestor 5000				
Dräger Quaestor 5000 Standard		R58316	1	D
Dräger Quaestor 5000 CCBA		R58318	1	D
Dräger Quaestor 5000 SV		R58365	1	D
Dräger Quaestor 5000 CCBA/SV		R58366	1	D

Place You Put Your Faith

PERSONAL PROTECTIVE EQUIPMENT

PRODUCT	DESCRIPTION	PART NO	PACKAGING UNIT	CATEGORY
---------	-------------	---------	----------------	----------



All Static and dynamic Tests of the Dräger Quaestor 7000 are carried out fully automatically. Controlled by the newly developed software each test is carried out intuitively. For the user this guarantees high efficiency through comfort and speed.

With the Dräger Quaestor 7000 it is possible to test the following components:

- Full Face Masks
- Chemical protection Suits (Accessories necessary)
- Airline Breathing Equipment
- Compressed air breathing apparatus

Available options for further Testing:

- Closed circuit breathing apparatus
- Safety valves of pressure reducer
- Diving apparatus

DRÄGER Quaestor 7000				
Dräger Quaestor 7000 Standard			R58312	1 D
Dräger Quaestor 7000 CCBA			R58313	1 D
Dräger Quaestor 7000 SV			R58314	1 D
Dräger Quaestor 7000 CCBA/SV			R58364	1 D
Accessories and Spare Parts				
Dräger QSI-Box	For the sound insulation of the low pressure warning		R58382	1 D
Helmet-Mask-Adapter	Holder to be attached to the test head for testing all Dräger Helmet-Mask combinations		R58116	1 D
Compressed air breathing apparatus holder	Used during the test to keep the compressed air breathing apparatus upright		R57420	1 D
Breathing adapter AG02535 546 1 357,00	Enables a positive leak tightness in accordance with vfdb 0408		AG02535	1 D
Gauge holder	For easy positioning of the gauge or Dräger Bodyguard on the test device		R58025	1 D
Hose CPS-Test R58504			R58504	1 D

Dräger Comfort Vest Cooling Vest

Increased performance by up to four hours - without the need for elaborate preparation or logistics: when work gets hot, the Dräger Comfort Vest CVP 5220 is always ready to use as it delivers the cooling action itself. This means: no pre-freezing, no dipping into water, no risk due to dangerous circulating air - and no time loss.



Place You Put Your Faith



D-19077-2010

PERSONAL PROTECTIVE EQUIPMENT

PRODUCT	DESCRIPTION	PART NO	PACKAGING UNIT	CATEGORY
---------	-------------	---------	----------------	----------

COOL VEST

Comfort Vest - CVP 5220



The CVP 5220 utilises 20 phase change material elements (PCM-elements) that when exposed to temperatures above 28°C will liquify and reduce the skin temperature by 3-4°C for up to 4 hours. The PCM-element contain a salt crystal mixture in a polyester/polamide pack. When returned to a cooler environment below 22°C the elements regenerate and become solid again. At 20°C they take approximatley 4 hours to regenerate and at 8°C they take approximatley 30 minutes



CVP 5220 & Accessories				
1. Comfort Vest	S/M (84cm-100cm)	R58762	1	D
1. Comfort Vest	L/XL (100cm-116cm)	R58763	1	D
1. Comfort Vest	XXL/XXXL (116cm-132cm)	R58764	1	D
1. Comfort Vest	XXXXL/XXXXXL (132cm-148m)	R58761	1	D
2. PCM Element Large	20 per vest. Max 3 year replacement interval	R45104	1	D
Transportation Bag Blue		R53373	1	D

PERSONAL PROTECTIVE EQUIPMENT

Dräger SPC 3700 with CVA 0700 Splash Suit and Vest

The Dräger constant flow disposable suit SPC 3700 in combination with the unique vest CVA 0700 offers ideal protection, comfort and flexibility. The liquid-tight protective suit (type 3) protects the wearer from contact with chemicals and allows greater movement, while the vest provides the necessary breathing and ventilation air for a pleasant cooling effect.



PERSONAL PROTECTIVE EQUIPMENT

PRODUCT	DESCRIPTION	PART NO	PACKAGING UNIT	CATEGORY
---------	-------------	---------	----------------	----------

CVA 0700 & SPC 3700 AIR FED CHEMICAL PROTECTION SUITS

CVA 0700



The CVA 0700 is an air fed cool vest intended primarily to be used inside the SPC 3700 inflatable chemical protection suits. 10 year lifetime, 300-400 l/min.

Re-release Q1/Q2 2018

CVA 0700 Air Vest	Complete vest and airline belt manifold	3363602	1	D
-------------------	---	---------	---	---

SPC 3700 Air Fed Suit

The Dräger constant flow disposable suit SPC 3700 in combination with the unique vest CVA 0700 offers ideal protection, comfort and flexibility. The liquid-tight protective suit (type 3) protects the wearer from contact with chemicals and allows greater movement, while the vest provides the necessary breathing and ventilation air for a pleasant cooling effect.



- Integrated overshoes with antistatic sole (PVC) (Boots will be worn inside the suit)
- Laminate gloves
- Arm cuffs
- 5 year storage time
- 10 year lifetime



- Integrated socks with leg cuffs (Boots will be worn over the socks)
- Camatril® gloves
- No arm cuffs
- 5 year storage time
- 10 year lifetime

Please You Put Your Faith

SPC 3700 - Grey (Tychem F)

SPC 3700 grey, size S	Height 1.62 - 1.70 m	R58765	1	D
SPC 3700 grey, size M	Height 1.68 - 1.76 m	R58766	1	D
SPC 3700 grey, size L	Height 1.74 - 1.82 m	R58767	1	D
SPC 3700 grey, size XL	Height 1.80 - 1.88 m	R58768	1	D
SPC 3700 grey, size XXL	Height 1.86 - 1.94 m	R58769	1	D
SPC 3700 grey, size XXXL	Height 1.92 - 2.00 m	R58770	1	D

SPC 3700 - Yellow (Tychem C)

SPC 3700 yellow, size S	Height 1.62 - 1.70 m	R62421	1	D
SPC 3700 yellow, size M	Height 1.68 - 1.76 m	R62422	1	D
SPC 3700 yellow, size L	Height 1.74 - 1.82 m	R62423	1	D
SPC 3700 yellow, size XL	Height 1.80 - 1.88 m	R62424	1	D
SPC 3700 yellow, size XXL	Height 1.86 - 1.94 m	R62425	1	D
SPC 3700 yellow, size XXXL	Height 1.92 - 2.00 m	R62426	1	D

Dräger Region South East Europe | Rev: 0 | Subject to modification! | www.draeger.com

Please You Put Your Faith

PORTABLE
GAS DETECTION

PERSONAL
PROTECTION
EQUIPMENT

DRUG & ALCOHOL
DETECTION

MASKS & FILTERS

FIRE & GAS
DETECTION
SYSTEMS

ENGINEERED
SOLUTIONS

SERVICE,
TRAINING & RENTAL

DIVING
TECHNOLOGY

PERSONAL PROTECTIVE EQUIPMENT

Suit Material options & their resistance to chemical permeation according to EN 369

	Tychem C	Tychem F
Acetone	0	6
Acetonitrile	0	6
Ammonia	0	6
Carbon disulphide	0	6
Chlorine	0	6
Diethylamine	0	6
Ethyl acetate	0	6
Ethylene glycol	6	6
Hexane	0	6
Hydrogen chloride	0	6
Hydrofluoric acid 70%	2	5
Mercury	6	6
Methanol	0	6
Nitric acid 70%	6	6
Phosphoric acid 85%	6	6
Sodium hydroxide	6	6
Sulphuric acid 93 %	6	6
Tetrahydrofurane	0	6
Toluene	0	6

Class 0: Immediate	0
Class 1: > 10 minutes	1
Class 2: > 30 minutes	2
Class 3: > 60 minutes	3
Class 4: > 120 minute	4
Class 5: > 240 minutes	5
Class 6: > 480 minutes	6

PERSONAL PROTECTIVE EQUIPMENT

PRODUCT	DESCRIPTION	PART NO	PACKAGING UNIT	CATEGORY
---------	-------------	---------	----------------	----------

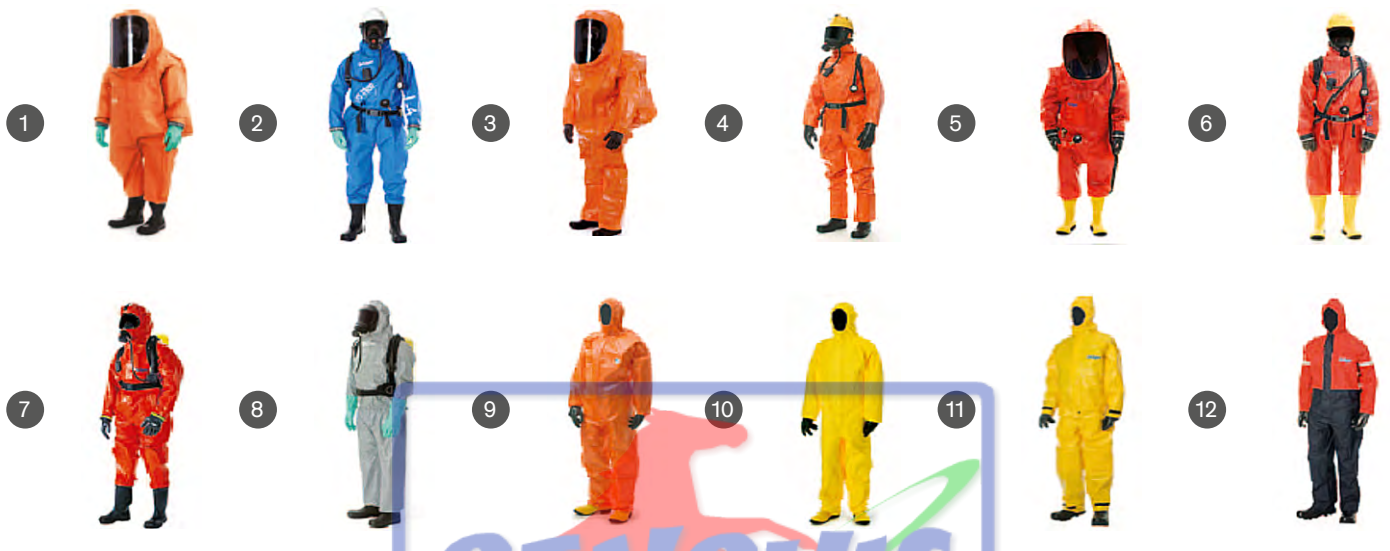

SUBSTANCE IS KNOWN AND SITUATION IS UNDER CONTROL

SUBSTANCE AND SITUATION ARE UNKNOWN (E.G. FIRST SITE EVALUATION) OR SPECIAL HAZARDS ARE TO BE EXPECTED

			Liquids / Solids	Known gases*	Unknown gases*	Mechanical stress	Liquefied gases	Working in explosive zones	Archtroughs / Breakthroughs
Dräger protective suit	Breathing apparatus								
1	CPS 7900	Inside: SCBA	•	•	•	•	•	•	•
2	CPS 7800	Outside: F / SCBA	•	•	•	•			
3	CPS 5900	Inside: SCBA	•	•	•				
4	CPS 5800	Outside: F / SCBA	•	•	•				
5	CPS 6900	Inside: SCBA	•	•			•		
6	CPS 6800	Outside: F / SCBA	•	•					
7	WorkMaster Industry	Outside: F / SCBA	•	•					
8	SPC 3800	Outside: F / SCBA	•						
9	Protec Plus TF	Outside: WO / F / SCBA	•						
10	Protec Plus TC	Outside: WO / F / SCBA	•						
11	WorkStar PVC	Outside: WO / F / SCBA	•						
12	WorkStar Flexothane	Outside: WO / F / SCBA	•						

F = Filter, SCBA = Self Contained Breathing Apparatus, WO = No Breathing Apparatus

*See VOICE (hazardous substances database) for resistance data at www.draeger.com/voice

PERSONAL PROTECTIVE EQUIPMENT

5 QUESTIONS TO OBTAIN THE RIGHT PROTECTIVE SUIT



1. Which hazardous substances are you exposed to during your work?

- If you know the hazardous substance, you can take tangible measures to protect yourself. The Dräger VOICE Hazardous Substances Database lets you know which suit protects against which hazardous materials and for how long.
- If you do not know the hazardous substance, always assume the worst case scenario and select the next higher degree of protection.

2. Do you have to wear breathing apparatus during your work?

- If no respiratory protection is needed, simple overalls or other protective clothing that protect against the respective chemical agents will be sufficient.
- If you work with filter equipment, it is best to use a suit equipped with integrated full-face mask or facial sleeve.
- If you need an SCBA, make sure the equipment is comfortable to wear either over or under your protective suit.

3. What is your work environment like

- A traffic accident requires you to reach in between or handle sharp-edged objects. A protective suit with a higher mechanical strength, such as a reusable model, is recommended when your work environment is unpredictable.
- If damage is unlikely, you can also use a limited-use suit.

4. How easily can the pollution caused by the hazardous substance be removed (decontamination)?

- If the hazardous substance is difficult to remove from surfaces, you should wear a protective suit with the breathing apparatus worn on the inside of the suit. By this means you can protect it from contamination.

5. What are the associated risks of working with the hazardous substance?

- If it is a very cold hazardous substance such as liquefied gas, the material of the suit must not become brittle or fracture when exposed to the cold.
- If the hazardous substance is flammable at ambient temperatures, the protective suit must be flame-resistant.
- If there is a risk of explosion in the area where the hazardous substance is leaking, the suit must have the relevant electrostatic properties.
- If the hazardous substance is a toxic gas, only a gas-tight chemical protection suit should be used, never a splash-guard suit.

Dräger Protec Plus Chemical protection coveralls

Chemical protection coveralls are used whenever and wherever a person's skin has to be protected from the harmful effects of hazardous substances. If there is a risk that the entire body could come into contact with solid or liquid chemicals, complete coveralls are the only way of ensuring full protection.



Dräger Protec Plus chemical protection coveralls protect against spray and splashes, and are made of coated Tychem® material. The hood, sleeves and cuffs of the trousers are fitted with elastic drawstrings keeping splashes out. The zip fastener runs down the middle of the front side and is fitted with two cover strips held in place by tape. There is an elastic seal in the neck area that ensures a seal with a fullface mask, like the Dräger X-plore®.

The welded seams of these one-piece coveralls are also impermeable to liquids and designed for use with filtering respirators and self-contained breathing equipment.

Dräger Protec Plus coveralls provide the best possible protection against ultra-fine dusts and powders, acids and alkalis, and are particularly resistant to a broad spectrum of chemicals in liquid form.

Dräger Protec Plus chemical protection coveralls are CE-certified and classified as chemical-protection Types 3, 4, 5 and 6. They are also tested for anti-static properties under EN 1149-1.

There are two types available: **DRÄGER PROTEC PLUS TC - TYCHEM® C**. These coveralls provide protection against ultra-fine dusts and powders, and are an effective barrier to many inorganic acids and alkalis as well as water-based salt solutions.

Examples of use: paint shops, agricultural chemicals, asbestos disposal, disinfection, industrial cleaning, resin and glass fibre processing, industrial paints, virus and blood protection, etc.

DRÄGER PROTEC PLUS TF - TYCHEM® F. These coveralls provide protection against many concentrated inorganic acids and alkalis and large number of organic chemicals.

Examples of use: decontamination work, inspections, handling oil.

The Chemical protection coveralls Dräger Protec Plus - another Quality Product from Dräger.

Tyvek® and Tychem® are the registered trademarks of DuPont or one of its subsidiary companies.



Dräger Protec Plus TC
Tychem® C



Dräger Protec Plus TF
Tychem® F

PERSONAL PROTECTIVE EQUIPMENT

PRODUCT	DESCRIPTION	PART NO	PACKAGING UNIT	CATEGORY
---------	-------------	---------	----------------	----------

PROTEC PLUS - SPLASH SUITS

Protec Plus TC - Splash Suits

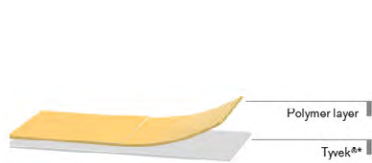

The Protec Plus TC offers protection against fine hazardous dusts and powders, many inorganic acids and bases in liquid form and water-based salt solutions.

- Material: Tychem® C; silicone-free and lint-free
- Color: yellow
- Weight: approx. 320 g
- No gloves or boots

Protec Plus TC - Splash Suits

Protec Plus TC, size M	H -162cm to 170cm, W - 84cm to 92cm	R54860	1	D
Protec Plus TC, size L	H -168cm to 176cm, W - 92cm to 100cm	R54861	1	D
Protec Plus TC, size XL	H -174cm to 182cm, W - 100cm to 108cm	R54862	1	D
Protec Plus TC, size XXL	H -180cm to 188cm, W - 108cm to 116cm	R54863	1	D
Protec Plus TC, size XXXL	H -186cm to 194cm, W - 116cm to 124cm	R58542	1	D

Protec Plus TF - Splash Suits

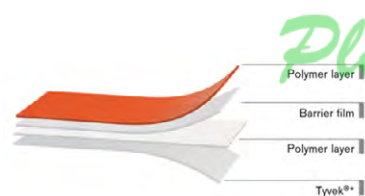

The Protec Plus TF offers protection against many concentrated inorganic acids, bases and a wide range of organic chemicals in liquid form.

- Material: Tychem® F; silicone-free and lint-free
- Color: orange
- Weight: approx. 480 g
- No gloves or boots

Suits

Protec Plus TF, size M	H -162cm to 170cm, W - 84cm to 92cm	R54870	1	D
Protec Plus TF, size L	H -168cm to 176cm, W - 92cm to 100cm	R54871	1	D
Protec Plus TF, size XL	H -174cm to 182cm, W - 100cm to 108cm	R54872	1	D
Protec Plus TF, size XXL	H -180cm to 188cm, W - 108cm to 116cm	R54873	1	D
Protec Plus TF, size XXXL	H -186cm to 194cm, W - 116cm to 124cm	R58543	1	D

See boots and gloves page for options

PERSONAL PROTECTIVE EQUIPMENT

Dräger SPC 2400 PVC / Flexothane Splash Suit

The Dräger SPC 2400 is a reusable suit, which is reliable in protecting you from liquids and dust. The suit is available in a specially robust version made of PVC or as a light, water vapour permeable version made of flexothane.

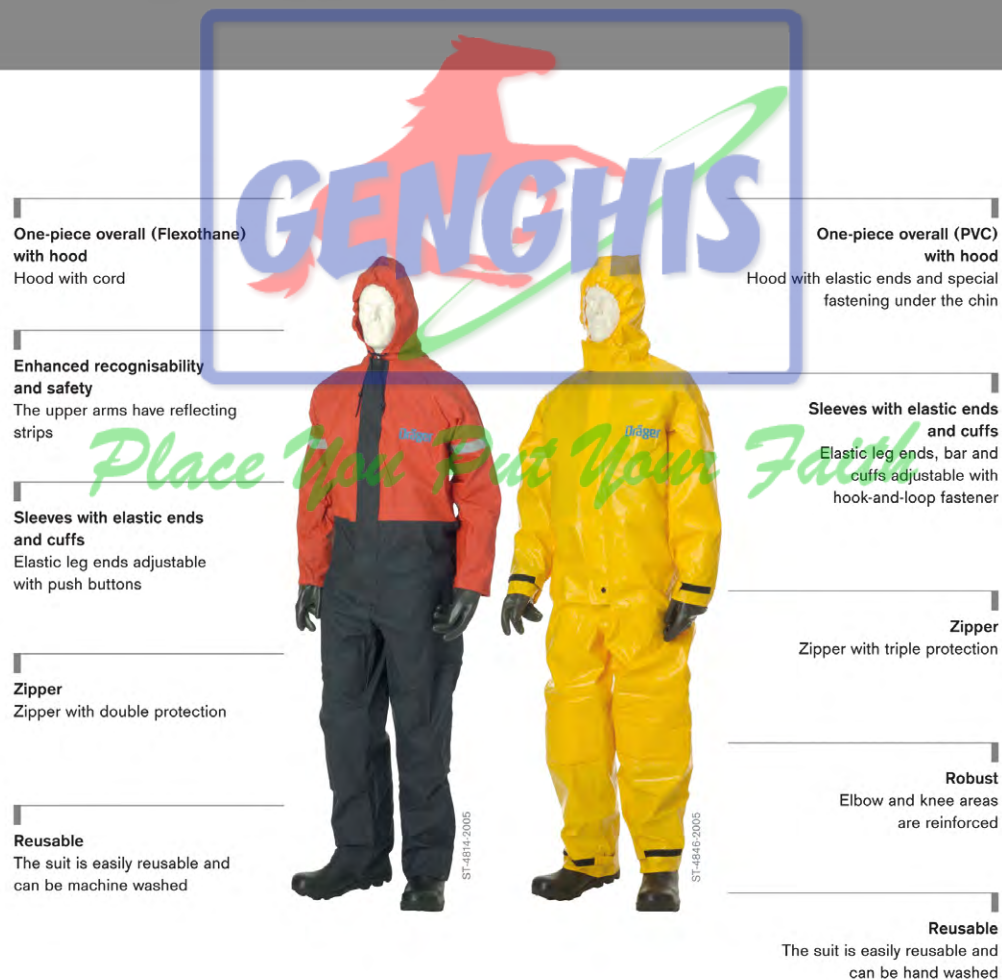

PERSONAL PROTECTIVE EQUIPMENT

PRODUCT	DESCRIPTION	PART NO	PACKAGING UNIT	CATEGORY
---------	-------------	---------	----------------	----------

PROTEC PLUS - SPLASH SUITS

Protec Plus TC - Splash Suits

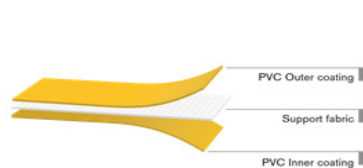

The SPC 2400 PVC is an overall with hood for protection against solid and liquid chemicals, approved to type 3 and 4. Fabric supported PVC-material, very sturdy. Especially liquid tight due to special design of covers at hood and zip fastener. Ideal for working with a broad range of hazardous liquids and solids. 5 Year storage life. No boots or gloves Included

Suits				
SPC 2400 PVC, size S	H -164cm to 182cm, W - 88cm to 96cm	R62806	1	D
SPC 2400 PVC, size M	H -164cm to 182cm, W - 96cm to 104cm	R62807	1	D
SPC 2400 PVC, size L	H -170cm to 188cm, W - 104cm to 112cm	R62808	1	D
SPC 2400 PVC, size XL	H -170cm to 188cm, W - 112cm to 120cm	R62809	1	D
SPC 2400 PVC, size XXL	H -176cm to 194cm, W - 120cm to 128cm	R62810	1	D
SPC 2400 PVC, size XXXL	H -182cm to 200cm, W - 128cm to 136cm	R62811	1	D

Protec Plus TF - Splash Suits



The WorkStar Flexothane is an overall with hood for protection against solid and liquid chemicals, approved to type 4. Material permeable to water vapour with high wearing comfort. Zip fastener with cover flap made of suit material. Ideal for work with oils, lubricants, gasoline, Diesel, etc. 2 Year storage life. No boots or gloves Included

Suits				
WorkStar Flexothane, size M	H -164cm to 182cm, W - 96cm to 104cm	R54522	1	D
WorkStar Flexothane, size L	H -170cm to 188cm, W - 104cm to 112cm	R54523	1	D
WorkStar Flexothane, size XL	H -170cm to 188cm, W - 112cm to 120cm	R54524	1	D
WorkStar Flexothane, size XXL	H -176cm to 194cm, W - 120cm to 128cm	R54998	1	D

See boots and gloves page for options

PERSONAL PROTECTIVE EQUIPMENT

Dräger SPC 3800 Splash Suit

Chemical protective suits are used whenever and wherever a person's skin has to be protected from the harmful effects of hazardous liquids. If there is a risk that the entire body may come into contact with solid or liquid chemicals, complete coveralls are the only way to ensure full protection.

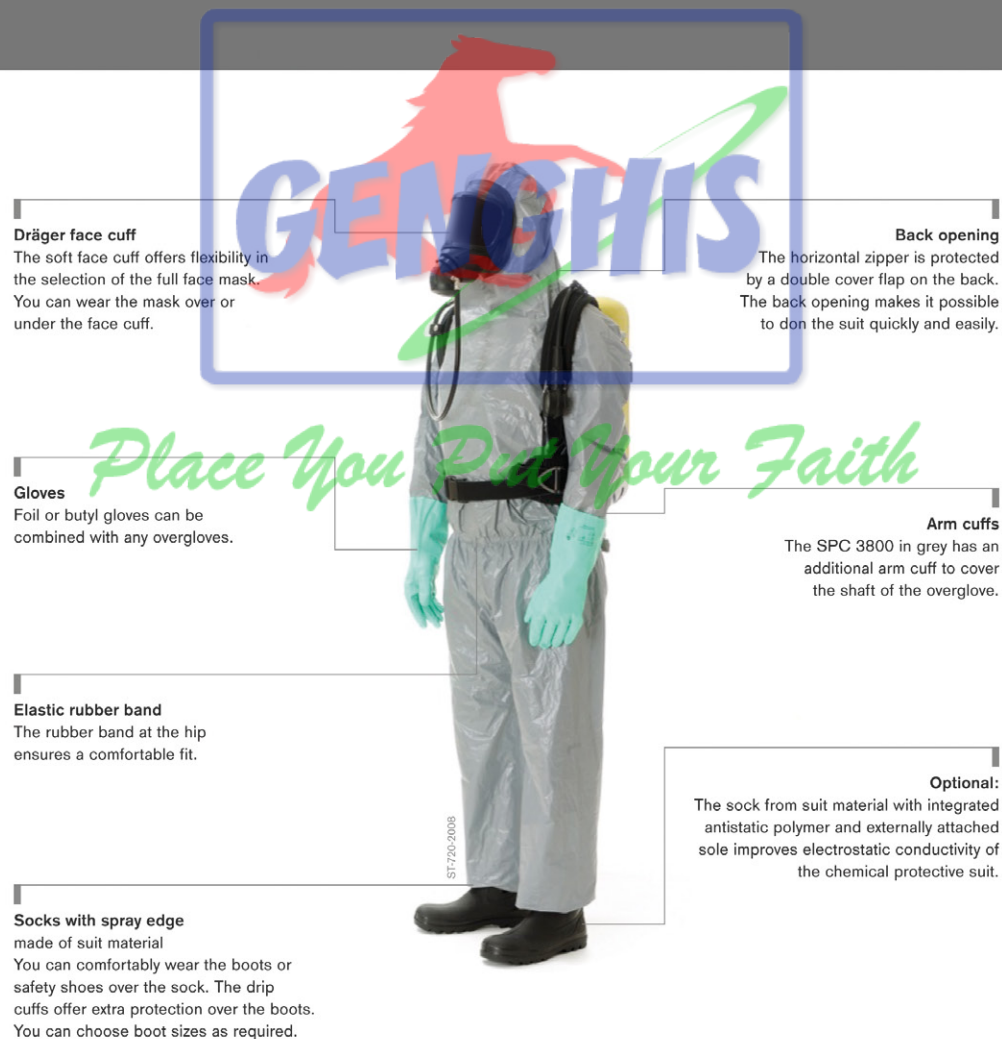

PERSONAL PROTECTIVE EQUIPMENT

PRODUCT	DESCRIPTION	PART NO	PACKAGING UNIT	CATEGORY
---------	-------------	---------	----------------	----------

SPC 3800 - SPLASH SUITS

SPC 3800 Grey - Splash Suits

The Dräger SPC 3800, type 3 & 4, offers protection against many concentrated inorganic acids, bases and a wide range of organic chemicals in liquid form.

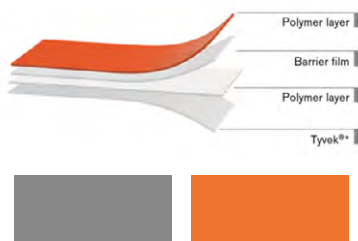

- Material: Tychem® F; silicone-free and lint-free
- Face cuff (under or over mask)
- Weight: approx. 660 g
- Welded laminate gloves & Arm cuffs
- Stitched socks with boot flaps
- Zipper horizontal on back
- Elastic waist strap
- 5 Year storage life
- Single use when contaminated or reusable if adhesive strip over zip is not sealed during use

Suits					
SPC 3800 grey, size S	H -160cm to 170cm, W - 84cm to 92cm	R58286	1	D	
SPC 3800 grey, size M	H -168cm to 176cm, W - 92cm to 100cm	R57371	1	D	
SPC 3800 grey, size L	H -174cm to 182cm, W - 100cm to 108cm	R57372	1	D	
SPC 3800 grey, size XL	H -180cm to 188cm, W - 108cm to 116cm	R57373	1	D	
SPC 3800 grey, size XXL	H -186cm to 194cm, W - 116cm to 124cm	R57374	1	D	
SPC 3800 grey, size XXXL	H -192cm to 200cm, W - 124cm to 132cm	R58280	1	D	

Over glove required

Antistatic Suits

The SPC 3800 grey suit with antistatic-polymer for low electrical resistance. Use in combination with the ESD PVC Boots

SPC 3800 grey, size S	H -160cm to 170cm, W - 84cm to 92cm	R62381	1	D	
SPC 3800 grey, size M	H -168cm to 176cm, W - 92cm to 100cm	R62382	1	D	
SPC 3800 grey, size L	H -174cm to 182cm, W - 100cm to 108cm	R62383	1	D	
SPC 3800 grey, size XL	H -180cm to 188cm, W - 108cm to 116cm	R62384	1	D	
SPC 3800 grey, size XXL	H -186cm to 194cm, W - 116cm to 124cm	R62385	1	D	
SPC 3800 grey, size XXXL	H -192cm to 200cm, W - 124cm to 132cm	R62386	1	D	

Over glove required

See boots and gloves page for options

PERSONAL PROTECTIVE EQUIPMENT

PRODUCT	DESCRIPTION	PART NO	PACKAGING UNIT	CATEGORY
---------	-------------	---------	----------------	----------

SPC 3800 Orange - Splash Suits

The Dräger SPC 3800, type 3 & 4, offers protection against many concentrated inorganic acids, bases and a wide range of organic chemicals in liquid form.

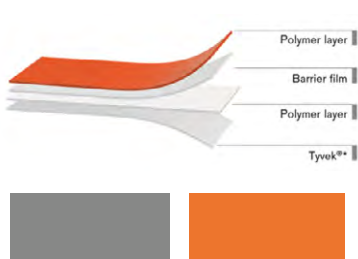

- Material: Tychem® F; silicone-free and lint-free
- Face cuff (under or over mask)
- Weight: approx. 840 g
- Welded Butyl® gloves
- Stitched socks with boot flaps
- Zipper horizontal on back
- Elastic waist strap
- 5 Year storage life
- Single use when contaminated or reusable if adhesive strip over zip is not sealed during use

Suits

SPC 3800 orange, size S	H -160cm to 170cm, W - 84cm to 92cm	R58287	1	D
SPC 3800 orange, size M	H -168cm to 176cm, W - 92cm to 100cm	R57375	1	D
SPC 3800 orange, size L	H -174cm to 182cm, W - 100cm to 108cm	R57376	1	D
SPC 3800 orange, size XL	H -180cm to 188cm, W - 108cm to 116cm	R57377	1	D
SPC 3800 orange, size XXL	H -186cm to 194cm, W - 116cm to 124cm	R57378	1	D
SPC 3800 orange, size XXXL	H -192cm to 200cm, W - 124cm to 132cm	R58285	1	D

See boots and gloves pages for options

Place You Put Your Faith

PERSONAL PROTECTIVE EQUIPMENT

Suit Material options & their resistance to chemical permeation according to EN 369

	Tychem C	Tychem F	PVC	Flexothane
Acetone	0	6	0	NT
Acetonitrile	0	6	0	NT
Ammonia	0	6	NT	NT
Carbon disulphide	0	6	NT	NT
Chlorine gas	0	6	NT	NT
Diethylamine	0	6	0	0
Ethyl acetate	0	6	0	NT
Ethylene glycol	6	6	NT	NT
Hexane	0	6	0	0
Hydrogen chloride	0	6	NT	NT
Hydrofluoric acid 70%	2	5	NT	NT
Mercury	6	6	NT	NT
Methanol	0	6	1	NT
Nitric acid 70%	6	6	NT	NT
Phosphoric acid 85%	6	6	NT	NT
Sodium hydroxide solution	6	6	6	4
Sulphuric acid 93 %	6	6	3	0
Tetrahydrofurane	0	6	NT	NT
Toluene	0	6	0	0

Class 0: Immediate	0
Class 1: > 10 minutes	1
Class 2: > 30 minutes	2
Class 3: > 60 minutes	3
Class 4: > 120 minute	4
Class 5: > 240 minutes	5
Class 6: > 480 minutes	6
NT = Not tested	

PERSONAL PROTECTIVE EQUIPMENT

Dräger CPS 5800 Gas-Tight Suit

The Dräger CPS 5800 is a limited-use chemical protective suit for industrial applications and operations on board that involve a gaseous, liquid or solid hazardous substance.



Soft and flexible face cuff made from Butyl

- Can be worn under or on top of the mask
- High degree of wearing comfort on the head and face
- Simple donning and doffing without connected mask – still gas-tight

Zippers

- Zipper with external chain – downward direction of fastening: for simple donning and doffing
- Protected by double flap with continuous Velcro strip

Permanently attached glove combination

- Increased chemical protection: laminate gloves (inside) and butyl gloves (outside)

Dräger relief valve

- To let air out of the suit: simplifies access to confined spaces

Large opening for donning and doffing (diagonally across the front)

- No help of a second person required for donning

Integrated gas-tight socks

- Suitable for use with different boot sizes
- With splash protection cover that prevents fluids from running into the boots

D-130806-2010

PERSONAL PROTECTIVE EQUIPMENT

PRODUCT	DESCRIPTION	PART NO	PACKAGING UNIT	CATEGORY
---------	-------------	---------	----------------	----------

CPS 5800 - LIMITED USE SUIT

CPS 5800

The CPS 5800 is a gas tight suit made of 3 layer Zytron 500. The breathing apparatus is worn on the outside of the suit. It provides excellent protection against a broad range of substances. It is classified as a limited use suit which means any prolonged exposure to heat or UV or if the suit was contaminated with a toxic or unknown chemical then it should be removed from service.



Shelf Life - 10 years
 Maintenance - Every Year
 Lead Times - Typically 3 weeks if not in stock
 Glove Combination - Laminate & Butyl. Optional overgloves available
 Integrated Socks - Same as suit material with boot flaps. Add boots
 Zip - Diagonal in front
 Lead Times - Typically 3 weeks if not in stock
 Storage - Comes in a transport bag

CPS 5800				
CPS 5800 Size M	160 cm to 175 cm	R57787	1	D
CPS 5800 Size L	170 cm to 185 cm	R57788	1	D
CPS 5800 Size XL	180 cm to 190 cm	R57789	1	D
CPS 5800 Size XXL	185 cm to 200 cm	R57790	1	D

See boots and gloves pages for options

Place You Put Your Faith

Dräger CPS 5900 Gas-Tight Suit

The Dräger CPS 5900 is the ideal disposable, gas-tight chemical protective suit for hazmat incidents. Where complete protection against hazardous gases, liquids and particles is of the utmost priority, this lightweight garment is the suit of choice.



Place You Put Your Faith

D-22755-2009

PERSONAL PROTECTIVE EQUIPMENT

PRODUCT	DESCRIPTION	PART NO	PACKAGING UNIT	CATEGORY
---------	-------------	---------	----------------	----------

CPS 5900 - LIMITED USE SUIT

CPS 5900

The CPS 5900 is a gas tight fully encapsulated suit made of orange 3 layer Zytron 500. It provides excellent protection against a broad range of substances. It is classified as a limited use suit which means any prolonged exposure to heat or UV or if the suit was contaminated with a toxic or unknown chemical then it should be removed from service.



Shelf Life - 10 years
 Maintenance - Every Year
 Lead Times - Typically 3 weeks if not in stock
 Glove Combination - Laminate & Butyl
 Integrated Socks - Same as suit material with boot flaps
 Zip - Diagonal in front
 Storage - Comes in a transport bag

CPS 5900 (Orange)

CPS 5900 Size S	150 cm to 165 cm	R57781	1	D
CPS 5900 Size M	160 cm to 175 cm	R57782	1	D
CPS 5900 Size L	170 cm to 185 cm	R57783	1	D
CPS 5900 Size XL	180 cm to 190 cm	R57784	1	D
CPS 5900 Size XXL	185 cm to 200 cm	R57785	1	D

CPS 5900 (Orange) - With Passthrough for airline

CPS 5900 Size S	150 cm to 165 cm	R57984	1	D
CPS 5900 Size M	160 cm to 175 cm	R57957	1	D
CPS 5900 Size L	170 cm to 185 cm	R57958	1	D
CPS 5900 Size XL	180 cm to 190 cm	R57959	1	D
CPS 5900 Size XXL	185 cm to 200 cm	R57960	1	D

See boots and gloves pages for options

CPS 5900 - Training Suit (Yellow)

CPS 5900 Size S	150 cm to 165 cm	R58671	1	D
CPS 5900 Size M	160 cm to 175 cm	R58672	1	D
CPS 5900 Size L	170 cm to 185 cm	R58673	1	D
CPS 5900 Size XL	180 cm to 190 cm	R58674	1	D
CPS 5900 Size XXL	185 cm to 200 cm	R58675	1	D

PERSONAL PROTECTIVE EQUIPMENT

Dräger CPS 6800 Gas-Tight Suit

If you are looking for protection against cryogenic hazardous substances and low concentrations of acids and alkalis then the Dräger CPS 6800 chemical protective suit is the right choice. The new and innovative suit design is more flexible and allows you to comfortably enter confined spaces.

The face cuff on the Dräger CPS 6800 offers flexibility when choosing the full face mask

Alternatively, the Dräger CPS 6800 is also available with a permanently integrated Dräger Panorama Nova full face mask. The optimized hood design increases comfort when wearing a helmet.

The optional braces significantly increase wearing comfort.

The RV PT 120 L is an adjustable ventilation unit for cooling the suit interior.

The patented Dräger glove joint allows gloves to be changed quickly and without tools.

- Integrated safety boots make donning easier.
- Alternatively, gas-tight socks offer flexibility in the choice of boots.

D-90754-2013

PERSONAL PROTECTIVE EQUIPMENT

PRODUCT	DESCRIPTION	PART NO	PACKAGING UNIT	CATEGORY
---------	-------------	---------	----------------	----------

CPS 6800 - REUSABLE SUIT

CPS 6800 - Preconfigured Version & Accessories

The CPS 6800 is a gas tight suit with a 3 layer design incorporating UMEX material. The breathing apparatus is worn on the outside of the suit. It provides excellent protection against Chlorine & Ammonia and other cryogenic substances and has been tested for short-term exposure of -80°C. If the gloves of the suit are going to be exposed to these low temperatures we recommend cryogenic over-gloves.

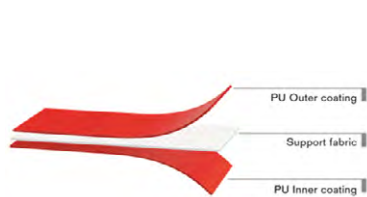

Shelf Life - 10 years

Maintenance - Every Year or every 2nd year when stored in the Transportation & Storage Bag that the preconfigured suit comes in

Lead Times - Typically 3 weeks for the preconfigured suits

CPS 6800 - Preconfigured				
CPS 6800 size L, PVC boots size 9, Butyl gloves size 10	Preconfigured Red suit that comes with face cuff, CPS storage & transport bag and cotton gloves	R62021	1	D
CPS 6800 size XL, PVC boots size 11 Butyl gloves size 11		R62022	1	D
CPS 6800 - Over & Inner Gloves				
Overgloves Tricotril, Size 10 (pair)	High cut protection from Kevlar, high mechanical resistance, good grip	R55968	1	D
Overgloves Tricotril, Size 11 (pair)		R55966	1	D
Overgloves K-Mex Gigant, Size 14 (pair)	High cut protection from Kevlar, high wearing comfort, wrist protection	R55969	1	D
Cotton gloves (Pair)	To wear inside the gloves for hygiene	R50972	1	D
CPS 6800 - Accessories				
CPS Hanger	Hanger in T-form (flexible)	R54746	1	D
Grease Sticks	Set of 2 to lubricate zip	R27494	1	D
Storage box	Blue with flap lid, stackable	T51525	1	D

Customisable suit with more options available on next page

PERSONAL PROTECTIVE EQUIPMENT

PRODUCT	DESCRIPTION	PART NO	PACKAGING UNIT	CATEGORY
---------	-------------	---------	----------------	----------

CPS 6800 - REUSABLE SUIT

CPS 6800 - Matrix Configured Version

The CPS 6800 is a gas tight suit with a 3 layer design incorporating UMEX material. The breathing apparatus is worn on the outside of the suit. It provides excellent protection against Chlorine & Ammonia and other cryogenic substances and has been tested for short-term exposure of -80°C. If the gloves of the suit are going to be exposed to these low temperatures we recommend cryogenic over-gloves.

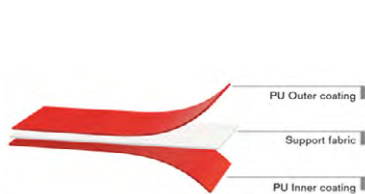

Shelf Life - 10 years

Maintenance - Every Year or every 2nd year when stored in the optional Transportation & Storage Bag

Lead Times - Typically 8 weeks for a custom designed suit via a matrix

CPS 6800 - Matrix configured - Suit				
CPS 6800 Configurator			R29460	1 D
CPS 6800 - Suit				
CPS 6800, size S	150 - 165cm	Matrix	1	D
CPS 6800, size M	160 - 175cm	Matrix	1	D
CPS 6800, size L	170 - 185cm	Matrix	1	D
CPS 6800, size XL	180 - 195cm	Matrix	1	D
CPS 6800, size XXL	190 - 205cm	Matrix	1	D
CPS 6800 - Face Connection				
Face cuff (gas-tight)	No face mask attached to suit	Matrix	1	D
Mask Panorama Nova P-Triplex	Positive pressure mask with glass visor	Matrix	1	D
Mask Panorama Nova RA-Triplex	Filter mask with glass visor	Matrix	1	D
CPS 6800 - Integrated Footwear				
Boots Nitril-P, size 9		Matrix	1	D
Boots Nitril-P, size 9.5		Matrix	1	D
Boots Nitril-P, size 10.5	Specially for fire brigades. Excellent resistance to cuts, abrasion and a wide range of chemicals.	Matrix	1	D
Boots Nitril-P, size 11.5	Antistatic, heat resistant up to 250°C for 1 hour.	Matrix	1	D
Boots Nitril-P, size 13		Matrix	1	D
Boots Nitril-P, size 14		Matrix	1	D
Boots PVC, size 9		Matrix	1	D
Boots PVC, size 9.5		Matrix	1	D
Boots PVC, size 10.5	Safety boots with steel toe and good resistance to perforation & certain chemicals	Matrix	1	D
Boots PVC, size 11.5		Matrix	1	D
Boots PVC, size 13		Matrix	1	D
Socks, size 7.5-9.5	Integrated socks instead of boots so boots can be changed easily as required. Recommend the use of boot covers found in accessories	Matrix	1	D
Socks, size 9.5-12		Matrix	1	D
Socks, size 12-14		Matrix	1	D
Sock cover	To slip easily into the boots when wearing a suit with integrated socks.	R61018	1	D

PERSONAL PROTECTIVE EQUIPMENT

PRODUCT	DESCRIPTION	PART NO	PACKAGING UNIT	CATEGORY
CPS 6800 - Integrated Gloves				
Gloves Barrier+Tricotril, Size 10	Best chemical resistant inner barrier glove & outer kevlar cut resistant glove. Single use only	Matrix	1	D
Gloves Barrier+Tricotril, Size 11		Matrix	1	D
Gloves Barrier+Tricotril, Size 10 + Cuff	Combination gloves with the gas tight arm cuff	Matrix	1	D
Gloves Barrier+Tricotril, Size 11 + Cuff		Matrix	1	D
Gloves Butyl, size 9	Lowest chemical resistance but reusable (optional Tricotril or K-mex overglove for good cut resistance)	Matrix	1	D
Gloves Butyl, size 10		Matrix	1	D
Gloves Butyl, size 11		Matrix	1	D
Gloves FKM, size 9	Lower chemical resistance but reusable (optional Tricotril or K-mex overglove for good cut resistance)	Matrix	1	D
Gloves FKM, size 10		Matrix	1	D
Gloves FKM, size 11		Matrix	1	D
Gloves FKM/Butyl, Size 9	Good chemical resistance but reusable (optional Tricotril or K-mex overglove for good cut resistance)	Matrix	1	D
Gloves FKM/Butyl, Size 10		Matrix	1	D
Gloves FKM/Butyl, Size 11		Matrix	1	D
Arm Cuffs (gas tight)	Internal seal to protect wearer in-case of glove leak	Matrix	1	D
CPS 6800 - Over & Inner Gloves				
Overgloves Tricotril, Size 10 (pair)	High cut protection from Kevlar, high mechanical resistance, good grip	Matrix	1	D
Overgloves Tricotril, Size 11 (pair)		Matrix	1	D
Overgloves K-Mex Gigant, Size 14 (pair)	High cut protection from Kevlar, high wearing comfort, wrist protection	Matrix	1	D
Cotton gloves (Pair)	To wear inside the gloves	Matrix	1	D
CPS 6800 - External Air Supply & Cooling				
Preparing suit for Regulation valve PT 120 L (assembling ventilation loops)	Preparation for ventilation so it can be added at a later date	Matrix	1	D
Regulation Valve PT 120 & Ventilation Loops	Air pass-through for cooling	Matrix	1	D
Regulation Valve cover		Matrix	1	D
CPS 6800 - Accessories				
CPS Hanger	Hanger in T-form (flexible)	R54746	1	D
Grease Sticks	Set of 2 to lubricate zip	R27494	1	D
Braces/Suspenders	Allows shorter people to use larger suits	Matrix	1	D
Transport Bag	Duffle Bag	R53373	1	D
CPS Storage and Transportation Bag	Black foldable bag	R58152	1	D
Storage box	Blue with flap lid, stackable	T51525	1	D
CPS 6800 - Customer Marking				
Customized marking on right arm, front side	In blue, white or reflective silver	Matrix	1	D
Customized marking on left arm, front side		Matrix	1	D
Customized marking on right arm, back side		Matrix	1	D
Customized marking on left arm, back side		Matrix	1	D
Customized marking on right upper leg		Matrix	1	D
Customized marking on left upper leg		Matrix	1	D

*Incl. means this accessory can be Included at no additional cost when ordered on a matrix. Other part numbers must be added separately.

PERSONAL PROTECTIVE EQUIPMENT

PRODUCT	DESCRIPTION	PART NO	PACKAGING UNIT	CATEGORY
---------	-------------	---------	----------------	----------

CPS 6800 - REUSABLE TRAINING SUIT

CPS 6800 Training - Matrix Configured Version



The CPS 6800/7800 Training is a training suit for the CPS 6800 and CPS 7800.

The training suit is not gas-tight, the seams are not welded, so that the suit does not offer any protection. It is only suitable for training exercises without real hazardous substances. The suit is distinguishable from the Dräger CPS 6800 and CPS 7800 because of the other material (blue Umex) and it is clear marked as a training suit.

Lead Times - Typically 8 weeks for a custom designed suit via a matrix

CPS 6800 - Matrix configured - Suit				
CPS 6800 Training Configurator		R29660	1	D
CPS 6800 - Suit				
CPS 6800, size S	150 - 165cm	Matrix	1	D
CPS 6800, size M	160 - 175cm	Matrix	1	D
CPS 6800, size L	170 - 185cm	Matrix	1	D
CPS 6800, size XL	180 - 195cm	Matrix	1	D
CPS 6800, size XXL	190 - 205cm	Matrix	1	D
CPS 6800 - Face Connection				
Face cuff (gas-tight)	No face mask attached to suit	Matrix	1	D
Mask Panorama Nova P-Triplex	Positive pressure mask with glass visor	Matrix	1	D
Mask Panorama Nova RA-Triplex	Filter mask with glass visor	Matrix	1	D
CPS 6800 - Integrated Footwear				
Boots PVC, size 9		Matrix	1	D
Boots PVC, size 9.5		Matrix	1	D
Boots PVC, size 10.5	Safety boots with steel toe and good resistance to perforation & certain chemicals	Matrix	1	D
Boots PVC, size 11.5		Matrix	1	D
Boots PVC, size 13		Matrix	1	D
Socks, size 7.5-9.5	Integrated socks instead of boots so boots can be changed easily as required. Recommend the use of boot covers found in accessories	Matrix	1	D
Socks, size 9.5-12		Matrix	1	D
Socks, size 12-14		Matrix	1	D
Sock cover	To slip easily into the boots when wearing a suit with integrated socks.	R61018	1	D

PERSONAL PROTECTIVE EQUIPMENT

PRODUCT	DESCRIPTION	PART NO	PACKAGING UNIT	CATEGORY
CPS 6800 - Integrated Gloves				
Gloves Barrier+Tricotril, Size 10	Best chemical resistant inner barrier glove & outer kevlar cut resistant glove. Single use only	Matrix	1	D
Gloves Barrier+Tricotril, Size 11		Matrix	1	D
Gloves Butyl, size 9	Lowest chemical resistance but reusable (optional Tricotril or K-mex overglove for good cut resistance)	Matrix	1	D
Gloves Butyl, size 10		Matrix	1	D
Gloves Butyl, size 11		Matrix	1	D
CPS 6800 - Over & Inner Gloves				
Overgloves Tricotril, Size 10 (pair)	High cut protection from Kevlar, high mechanical resistance, good grip	Matrix	1	D
Overgloves Tricotril, Size 11 (pair)		Matrix	1	D
Overgloves K-Mex Gigant, Size 14 (pair)	High cut protection from Kevlar, high wearing comfort, wrist protection	Matrix	1	D
Cotton gloves (Pair)	To wear inside the gloves	Matrix	1	D
CPS 6800 - Ventilation for Cooling				
Preparing suit for Regulation valve PT 120 L (assembling ventilation loops)	Preparation for ventilation so it can be added at a later date	Matrix	1	D
Regulation Valve PT 120 & Ventilation Loops	Air pass-through for cooling	Matrix	1	D
CPS 6800 - Accessories				
CPS Hanger	Hanger in T-form (flexible)	R54746	1	D
Grease Sticks	Set of 2 to lubricate zip	R27494	1	D
Braces/Suspenders	Allows shorter people to use larger suits	Matrix	1	D
Transport Bag	Duffle Bag	R53373	1	D
CPS Storage and Transportation Bag	Black foldable bag	R58152	1	D
Storage box	Blue with flap lid, stackable	T51525	1	D
CPS 6800 - Customer Marking				
Customized marking on right arm, front side		Matrix	1	D
Customized marking on left arm, front side		Matrix	1	D
Customized marking on right arm, back side	In blue, white or reflective silver	Matrix	1	D
Customized marking on left arm, back side		Matrix	1	D
Customized marking on right upper leg		Matrix	1	D
Customized marking on left upper leg		Matrix	1	D

*Incl. means this accessory can be Included at no additional cost when ordered on a matrix. Other part numbers must be added separately.

PERSONAL PROTECTIVE EQUIPMENT

Dräger CPS 6900 Gas-Tight Suit

If you are looking for protection against cryogenic hazardous substances and low concentrations of acids and alkalis then the Dräger CPS 6900 chemical protective suit is the right choice. The new and innovative suit design is both flexible and comfortable.

Manometer mount for attaching a manometer or Bodyguard in the field of view of the wearer.

The length adjustment can be used to adapt the suit to individual body heights.

The D-Connect serves to attach e.g. measuring devices and can also be used for crash rescue.

- The PT 120 L control valve is an adjustable ventilation unit for cooling the suit interior.
- The Air-Connect is a connection to external breathing air supply.

The patented Dräger glove joint allows gloves to be changed quickly and without tools.

- Integrated safety boots make donning easier.
- Alternatively, gas-tight socks offer flexibility in the choice of boots.

D-D-90414-2018

PERSONAL PROTECTIVE EQUIPMENT

PRODUCT	DESCRIPTION	PART NO	PACKAGING UNIT	CATEGORY
---------	-------------	---------	----------------	----------

CPS 6900 - REUSABLE SUIT

CPS 6900 Preconfigured Version & Accessories

The CPS 6900 is a gas tight full encapsulated suit with a 3 layer design incorporating UMEX material. It provides excellent protection against Chlorine & Ammonia and other cryogenic substances and has been tested for short-term exposure of -80°C. If the gloves of the suit are going to be exposed to these low temperatures we recommend cryogenic over-gloves.



Shelf Life - 10 years

Maintenance - Every Year or every 2nd year when stored in the Transportation & Storage Bag that the preconfigured suit comes in

Lead Times - Typically 3 weeks for the preconfigured suits

CPS 6900 - Preconfigured				
CPS 6900 size L, PVC boots size 9, Butyl gloves size 10	Preconfigured Red suit that comes with CPS storage & transport bag and cotton gloves	R62023	1	D
CPS 6900 size XL, PVC boots size 11 Butyl gloves size 11		R62024	1	D
CPS 6900 - Over & Under Gloves				
Overgloves Tricotril, Size 10 (pair)	High cut protection from Kevlar, high mechanical resistance, good grip	R55968	1	D
Overgloves Tricotril, Size 11 (pair)		R55966	1	D
Overgloves K-Mex Gigant, Size 14 (pair)	High cut protection from Kevlar, high wearing comfort, wrist protection	R55969	1	D
Cotton gloves (Pair)	To wear inside the gloves for hygiene	R50972	1	D
CPS 6900 - Accessories				
Outer visor (set of 10)	Scratch protection	R57859	1	D
Storage box	Blue with flap lid, stackable	T51525	1	D
Grease Sticks	Set of 2 to lubricate zip	R27494	1	D
CPS Hanger	Hanger in T-form (flexible)	R54746	1	D
Bell Hanger	Stainless steel bell shaped hanger	R33299	1	D

Customisable suit with more options available on next page

PERSONAL PROTECTIVE EQUIPMENT

PRODUCT	DESCRIPTION	PART NO	PACKAGING UNIT	CATEGORY
---------	-------------	---------	----------------	----------

CPS 6900 - REUSABLE SUIT

CPS 6900 - Matrix Configured Version

The CPS 6900 is a gas tight full encapsulated suit with a 3 layer design incorporating UMEX material. It provides excellent protection against Chlorine & Ammonia and other cryogenic substances and has been tested for short-term exposure of -80°C. If the gloves of the suit are going to be exposed to these low temperatures we recommend cryogenic over-gloves.



Shelf Life - 10 years
 Maintenance - Every year or every 2nd year when stored in the optional transportation & storage bag
 Lead Times - Typically 8 weeks for a custom designed suit via a matrix

CPS 6900 - Matrix configured - Suit

CPS 6900 Configurator		R29460	1	D
CPS 6900 - Suit				
CPS 6900, size S	150 - 165cm	Matrix	1	D
CPS 6900, size M	160 - 175cm	Matrix	1	D
CPS 6900, size L	170 - 185cm	Matrix	1	D
CPS 6900, size XL	180 - 200cm	Matrix	1	D
CPS 6900, size XXL	195 - 210cm	Matrix	1	D
CPS 6900 - Integrated Footwear				
Boots Nitril-P, size 9		Matrix	1	D
Boots Nitril-P, size 9.5		Matrix	1	D
Boots Nitril-P, size 10.5	Specially for fire brigades. Excellent resistance to cuts, abrasion and a wide range of chemicals.	Matrix	1	D
Boots Nitril-P, size 11.5	Antistatic, heat resistant up to 250°C for 1 hour.	Matrix	1	D
Boots Nitril-P, size 13		Matrix	1	D
Boots Nitril-P, size 14		Matrix	1	D
Boots PVC, size 9		Matrix	1	D
Boots PVC, size 9.5		Matrix	1	D
Boots PVC, size 10.5	Safety boots with steel toe and good resistance to perforation & certain chemicals	Matrix	1	D
Boots PVC, size 11.5		Matrix	1	D
Boots PVC, size 13		Matrix	1	D
Boots PVC, size 14		Matrix	1	D
Socks, size 7.5-9.5	Integrated socks instead of boots so boots can be	Matrix	1	D
Socks, size 9.5-12	changed easily as required. Recommend the use of	Matrix	1	D
Socks, size 12-14	boot covers found in accessories	Matrix	1	D
Sock cover	To slip easily into the boots when wearing a suit with integrated socks.	R61018	1	D

PERSONAL PROTECTIVE EQUIPMENT

PRODUCT	DESCRIPTION	PART NO	PACKAGING UNIT	CATEGORY
CPS 6900 - Integrated Gloves				
Gloves Barrier+Tricotril, Size 10	Best chemical resistant inner barrier glove & outer kevlar cut resistant glove. Single use only	Matrix	1	D
Gloves Barrier+Tricotril, Size 11		Matrix	1	D
Gloves Butyl, size 9		Matrix	1	D
Gloves Butyl, size 10	Lowest chemical resistance but reusable (optional Tricotril or K-mex overglove for good cut resistance)	Matrix	1	D
Gloves Butyl, size 11		Matrix	1	D
Gloves FKM, size 9		Matrix	1	D
Gloves FKM, size 10	Lower chemical resistance but reusable (optional Tricotril or K-mex overglove for good cut resistance)	Matrix	1	D
Gloves FKM, size 11		Matrix	1	D
Gloves FKM/Butyl, Size 9		Matrix	1	D
Gloves FKM/Butyl, Size 10	Good chemical resistance but reusable (optional Tricotril or K-mex overglove for good cut resistance)	Matrix	1	D
Gloves FKM/Butyl, Size 11		Matrix	1	D
Arm Cuffs (gas tight)	Internal seal to protect wearer in-case of glove leak	Matrix	1	D
CPS 6900 - Over & Under Gloves				
Overgloves Tricotril, Size 10 (pair)	High cut protection from Kevlar, high mechanical resistance, good grip	Matrix	1	D
Overgloves Tricotril, Size 11 (pair)		Matrix	1	D
Overgloves K-Mex Gigant, Size 14 (pair)	High cut protection from Kevlar, high wearing comfort, wrist protection	Matrix	1	D
Cotton gloves (Pair)	To wear inside the gloves	Matrix	1	D
CPS 6900 - External Air Supply & Cooling				
Preparing suit for Regulation valve PT 120 L (assembling ventilation loops)	Preparation for ventilation so it can be added at a later date	Matrix	1	D
Regulation Valve PT 120	pass-through for cooling and breathing	Matrix	1	D
Air-Connect	pass-through for breathing only	Matrix	1	D
Y-Piece Switch-Over Valve (analog)		Matrix	1	D
Automatic Switch-Over Valve (digital)	PSS 7000/5000/3000	Matrix	1	D
Automatic Switch-Over Valve (digital)	PAS and other PSS	Matrix	1	D
Adapter Male to Female Coupling	to connect LDV or any male SCBA coupling	Matrix	1	D
Adapter Male to Male Coupling	to connect any female SCBA coupling	Matrix	1	D

PERSONAL PROTECTIVE EQUIPMENT

PRODUCT	DESCRIPTION	PART NO	PACKAGING UNIT	CATEGORY
CPS 6900 - Accessories				
Outer visor (set of 10)	Scratch protection	Matrix	1	D
Anti-Fog-Visor		Matrix	1	D
Height Adjustment	Allows shorter people to use larger suits	Matrix	1	D
D-Connect on left hip	Fitting for gas meters, tools, ropes	Matrix	1	D
D-Connect on right hip	Fitting for gas meters, tools, ropes	Matrix	1	D
CPS Storage and Transportation Bag	Foldable bag	Matrix	1	D
Storage box	Blue with flap lid, stackable	Matrix	1	D
Backpack pad	For use with the BG4	Matrix	1	D
Grease Sticks	Set of 2 to lubricate zip	R27494	1	D
CPS Hanger	Hanger in T-form (flexible)	R54746	1	D
Bell Hanger	Stainless steel bell shaped hanger	R33299	1	D
CPS 6800 - Matrix configured - Customer Marking				
Customized marking on sleeve		Matrix	1	D
Customized marking on backpack		Matrix	1	D
Customized marking on chest	In blue, white or reflective silver	Matrix	1	D
Customized marking on upper leg		Matrix	1	D
Customized marking on left upper arm		Matrix	1	D

*Incl. means this accessory can be Included at no additional cost when ordered on a matrix. Other part numbers must be added separately.

Place You Put Your Faith

PERSONAL PROTECTIVE EQUIPMENT

PRODUCT	DESCRIPTION	PART NO	PACKAGING UNIT	CATEGORY
---------	-------------	---------	----------------	----------

CPS 6900 - REUSABLE TRAINING SUIT

CPS 6900 Training - Matrix Configured Version



The CPS 6900/7900 Training is a training suit for the CPS 6900 and CPS 7900.

The training suit is not gas-tight, the seams are not welded, so that the suit does not offer any protection. It is only suitable for training exercises without real hazardous substances. The suit is distinguishable from the Dräger CPS 6900 and CPS 7900 because of the other material (blue Umex) and it is clear marked as a training suit.

Lead Times - Typically 8 weeks for a custom designed suit via a matrix

CPS 6900 - Matrix configured - Suit				
CPS 6900 Training Configurator		R29511	1	D
CPS 6900 - Suit				
CPS 6900, size S	150 - 165cm	Matrix	1	D
CPS 6900, size M	160 - 175cm	Matrix	1	D
CPS 6900, size L	170 - 185cm	Matrix	1	D
CPS 6900, size XL	180 - 195cm	Matrix	1	D
CPS 6900, size XXL	190 - 205cm	Matrix	1	D
CPS 6900 - Integrated Footwear				
Boots PVC, size 9		Matrix	1	D
Boots PVC, size 9.5		Matrix	1	D
Boots PVC, size 10.5	Safety boots with steel toe and good resistance to perforation & certain chemicals	Matrix	1	D
Boots PVC, size 11.5		Matrix	1	D
Boots PVC, size 13		Matrix	1	D
Socks, size 7.5-9.5	Integrated socks instead of boots so boots can be changed easily as required. Recommend the use of boot covers found in accessories	Matrix	1	D
Socks, size 9.5-12		Matrix	1	D
Socks, size 12-14		Matrix	1	D
Sock cover	To slip easily into the boots when wearing a suit with integrated socks.	R61018	1	D
CPS 6900 - Integrated Gloves				
Gloves Barrier+Tricotril, Size 10	Best chemical resistant inner barrier glove & outer kevlar cut resistant glove. Single use only	Matrix	1	D
Gloves Barrier+Tricotril, Size 11		Matrix	1	D
Gloves Butyl, size 9	Lowest chemical resistance but reusable (optional Tricotril or K-mex overglove for good cut resistance)	Matrix	1	D
Gloves Butyl, size 10		Matrix	1	D
Gloves Butyl, size 11		Matrix	1	D
Arm Cuffs (gas tight)	Internal seal to protect wearer in-case of glove leak	Matrix	1	D

PERSONAL PROTECTIVE EQUIPMENT

PRODUCT	DESCRIPTION	PART NO	PACKAGING UNIT	CATEGORY
CPS 6900 - Over & Inner Gloves				
Overgloves Tricotril, Size 10 (pair)	High cut protection from Kevlar, high mechanical	Matrix	1	D
Overgloves Tricotril, Size 11 (pair)	resistance, good grip	Matrix	1	D
Overgloves K-Mex Gigant, Size 14 (pair)	High cut protection from Kevlar, high wearing	Matrix	1	D
	comfort, wrist protection			
Cotton gloves (Pair)	To wear inside the gloves	Matrix	1	D
CPS 6900 - External Air Supply & Cooling				
Preparing suit for Regulation valve PT 120 L (assembling ventilation loops)	Preparation for ventilation so it can be added at a later date	Matrix	1	D
Regulation Valve PT 120	pass-through for cooling and breathing	Matrix	1	D
Air-Connect	pass-through for breathing only	Matrix	1	D
Y-Piece Switch-Over Valve (analog)		Matrix	1	D
Automatic Switch-Over Valve (digital)	PSS 7000/5000/3000	Matrix	1	D
Automatic Switch-Over Valve (digital)	PAS and other PSS	Matrix	1	D
Adapter Male to Female Coupling	to connect LDV or any male SCBA coupling	Matrix	1	D
Adapter Male to Male Coupling	to connect any female SCBA coupling	Matrix	1	D
CPS 6900 - Accessories				
Outer visor (set of 10)	Scratch protection	Matrix	1	D
Anti-Fog-Visor		Matrix	1	D
Height Adjustment	Allows shorter people to use larger suits	Matrix	1	D
D-Connect on left hip	Fitting for gas meters, tools, ropes	Matrix	1	D
D-Connect on right hip	Fitting for gas meters, tools, ropes	Matrix	1	D
CPS Storage and Transportation Bag	Foldable bag	Matrix	1	D
Storage box	Blue with flap lid, stackable	Matrix	1	D
Backpack pad	For use with the BG4	Matrix	1	D
Grease Sticks	Set of 2 to lubricate zip	R27494	1	D
CPS Hanger	Hanger in T-form (flexible)	R54746	1	D
Bell Hanger	Stainless steel bell shaped hanger	R33299	1	D
CPS 6900 - Customer Marking				
Customized marking on sleeve		Matrix	1	D
Customized marking on backpac		Matrix	1	D
Customized marking on chest	In blue, white or reflective silver	Matrix	1	D
Customized marking on upper leg		Matrix	1	D
Customized marking on left upper arm		Matrix	1	D

*Incl. means this accessory can be Included at no additional cost when ordered on a matrix. Other part numbers must be added separately.

PERSONAL PROTECTIVE EQUIPMENT

Dräger CPS 7800 Gas-Tight Suit

The reusable gas-tight Dräger CPS 7800 provides excellent protection against gaseous, liquid, aerosol and solid hazardous substances even in explosive areas. Due to its innovative material and the new suit design it offers increased flexibility and comfort when entering confined spaces and working with cryogenic substances.

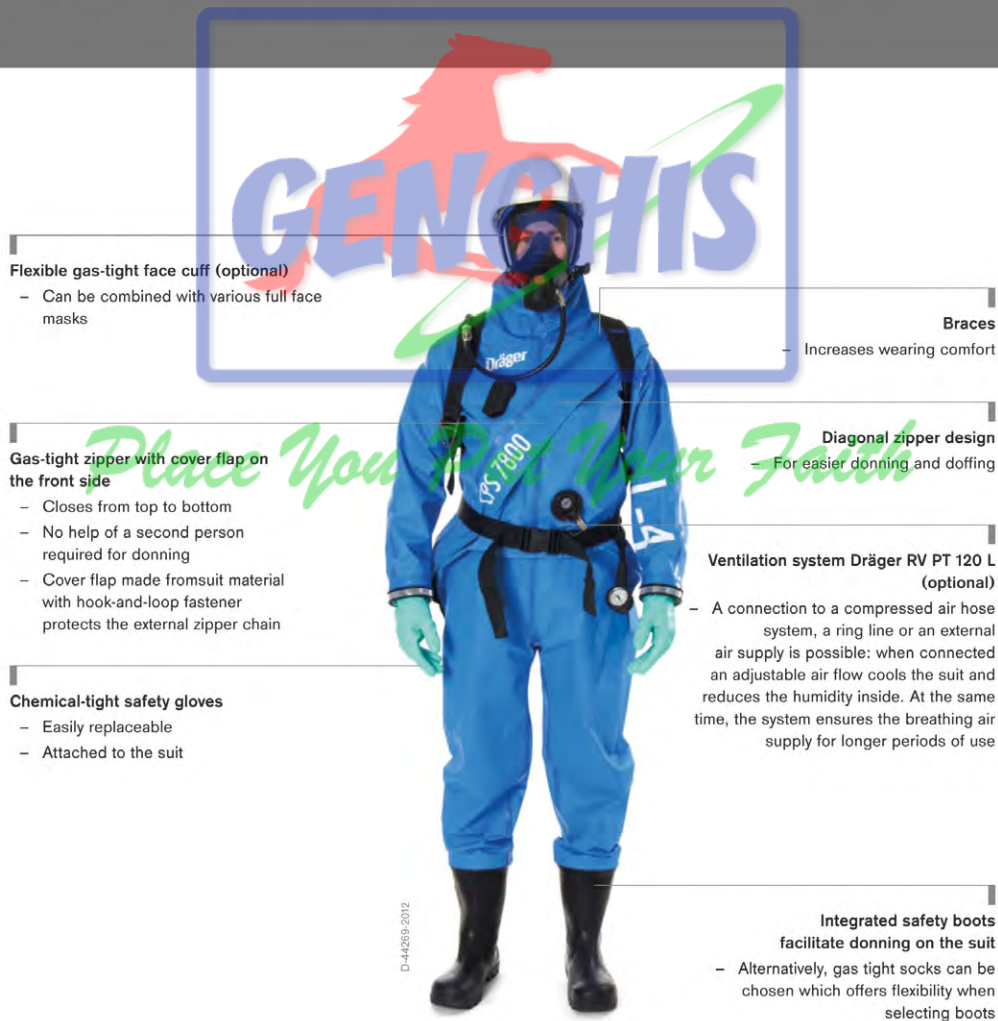

PERSONAL PROTECTIVE EQUIPMENT

PRODUCT	DESCRIPTION	PART NO	PACKAGING UNIT	CATEGORY
---------	-------------	---------	----------------	----------

CPS 7800 - REUSABLE SUIT

CPS 7800 - Preconfigured Version & Accessories

The CPS 7800 is a gas tight suit with a 5 layer design incorporating Dmex material. The breathing apparatus is worn on the outside of the suit. It provides excellent protection against a broad range of substances and can be used in explosive areas.



Shelf Life - 15 years

Maintenance - Every Year or every 2nd year when stored in the transportation & storage bag that the preconfigured suit comes in. Original & sealed suits don't require testing for the first 5 years.

Lead Times - Typically 3 weeks for the preconfigured suits

CPS 7800 - Preconfigured				
CPS 7800 size L, Nitril-P boots size 9, Laminate / Tricotril gloves size 10	Preconfigured orange suit that comes with face cuff, CPS storage & transport bag and cotton gloves	R59143	1	D
CPS 7800 size XL, Nitril-P boots size 11, Laminate / Tricotril gloves size 11		R59146	1	D
CPS 7800 - Over & Under Gloves				
Overgloves Tricotril, Size 10 (pair)	High cut protection from Kevlar, high mechanical resistance, good grip	R55968	1	D
Overgloves Tricotril, Size 11 (pair)		R55966	1	D
Overgloves K-Mex Gigant, Size 14 (pair)	High cut protection from Kevlar, high wearing comfort, wrist protection	R55969	1	D
Cotton gloves (Pair)	To wear inside the gloves for hygiene	R50972	1	D
CPS 7800 - Accessories				
Storage box	Blue with flap lid, stackable	T51525	1	D
Grease Sticks	Set of 2 to lubricate zip	R27494	1	D
CPS Hanger	Hanger in T-form (flexible)	R54746	1	D
Bell Hanger	Stainless steel bell shaped hanger	R33299	1	D

Customisable suit with more options available on next page

PERSONAL PROTECTIVE EQUIPMENT

PRODUCT	DESCRIPTION	PART NO	PACKAGING UNIT	CATEGORY
---------	-------------	---------	----------------	----------

CPS 7800 - REUSABLE SUIT

CPS 7800 - Matrix Configured Version

The CPS 7800 is a gas tight suit with a 5 layer design incorporating Dmex material. The breathing apparatus is worn on the outside of the suit. It provides excellent protection against a broad range of substances and can be used in explosive areas.



Shelf Life - 15 years

Maintenance - Every Year or every 2nd year when stored in the optional transportation & storage bag that the suit comes in. Original & sealed suits don't require testing for the first 5 years.

Lead Times - Typically 8 weeks for a custom designed suit via a matrix

CPS 7800 - Matrix configured - Suit				
CPS 7800 Configurator			R29650	1 D
CPS 7800 - Blue/Orange Suit				
CPS 7800, size S	150 - 165cm	Matrix	1	D
CPS 7800, size M	160 - 175cm	Matrix	1	D
CPS 7800, size L	170 - 185cm	Matrix	1	D
CPS 7800, size XL	180 - 195cm	Matrix	1	D
CPS 7800, size XXL	190 - 205cm	Matrix	1	D
CPS 7800 - Face Connection				
Face cuff (gas-tight)	No face mask attached to suit	Matrix	1	D
Mask Panorama Nova P-Triplex	Positive pressure mask with glass visor	Matrix	1	D
Mask Panorama Nova RA-Triplex	Filter mask with glass visor	Matrix	1	D
CPS 7800 - Integrated Footwear				
Boots Nitril-P, size 9		Matrix	1	D
Boots Nitril-P, size 9.5		Matrix	1	D
Boots Nitril-P, size 10.5	Specially for fire brigades. Excellent resistance to cuts, abrasion and a wide range of chemicals.	Matrix	1	D
Boots Nitril-P, size 11.5	Antistatic, heat resistant up to 250°C for 1 hour.	Matrix	1	D
Boots Nitril-P, size 13		Matrix	1	D
Boots Nitril-P, size 14		Matrix	1	D
Socks, size 7.5-9.5	Integrated socks instead of boots so boots can be changed easily as required. Recommend the use of boot covers found in accessories	Matrix	1	D
Socks, size 9.5-12		Matrix	1	D
Socks, size 12-14		Matrix	1	D
Sock cover	To slip easily into the boots when wearing a suit with integrated socks.	R61018	1	D

PERSONAL PROTECTIVE EQUIPMENT

PRODUCT	DESCRIPTION	PART NO	PACKAGING UNIT	CATEGORY
Gloves Barrier+Tricotril, Size 10	Best chemical resistant inner barrier glove & outer kevlar cut resistant glove. Single use only	Matrix	1	D
Gloves Barrier+Tricotril, Size 11		Matrix	1	D
Gloves Butyl, size 9	Lowest chemical resistance but reusable (optional Tricotril or K-mex overglove for good cut resistance)	Matrix	1	D
Gloves Butyl, size 10		Matrix	1	D
Gloves Butyl, size 11		Matrix	1	D
CPS 7800 - Over & Under Gloves				
Overgloves Tricotril, Size 10 (pair)	High cut protection from Kevlar, high mechanical resistance, good grip	Matrix	1	D
Overgloves Tricotril, Size 11 (pair)		Matrix	1	D
Overgloves K-Mex Gigant, Size 14 (pair)	High cut protection from Kevlar, high wearing comfort, wrist protection	Matrix	1	D
Cotton gloves (Pair)	To wear inside the gloves	Matrix	1	D
CPS 7800 - External Air Supply & Cooling				
Preparing suit for Regulation valve PT 120 L (assembling ventilation loops)	Preparation for ventilation so it can be added at a later date	Matrix	1	D
Regulation Valve PT 120	Pass-through for cooling	Matrix	1	D
Regulation Valve cover		Matrix	1	D
CPS 7800 - Accessories				
Braces	Allows shorter people to use larger suits	Matrix	1	D
Transport Bag	Duffle Bag	Matrix	1	D
CPS Storage and Transportation Bag	Foldable bag	Matrix	1	D
Storage box	Blue with flap lid, stackable	Matrix	1	D
Grease Sticks	Set of 2 to lubricate zip	R27494	1	D
CPS Hanger	Hanger in T-form (flexible)	R54746	1	D
Bell Hanger	Stainless steel bell shaped hanger	R33299	1	D
CPS 7800 - Customer Marking				
Customized marking on right arm, front side	In blue, white or reflective silver	Matrix	1	D
Customized marking on left arm, front side		Matrix	1	D
Customized marking on right arm, back side		Matrix	1	D
Customized marking on left arm, back side		Matrix	1	D
Customized marking on right upper leg		Matrix	1	D
Customized marking on left upper leg		Matrix	1	D

*Incl. means this accessory can be Included at no additional cost when ordered on a matrix. Other part numbers must be added separately.

PERSONAL PROTECTIVE EQUIPMENT

PRODUCT	DESCRIPTION	PART NO	PACKAGING UNIT	CATEGORY
---------	-------------	---------	----------------	----------

CPS 7800 - REUSABLE TRAINING SUIT

CPS 7800 Training - Matrix Configured Version



The CPS 7800/7800 Training is a training suit for the CPS 7800 and CPS 7800.

The training suit is not gas-tight, the seams are not welded, so that the suit does not offer any protection.

It is only suitable for training exercises without real hazardous substances. The suit is distinguishable from the Dräger CPS 7800 and CPS 7800 because of the other material (blue Umex) and it is clear marked as a training suit.

Lead Times - Typically 8 weeks for a custom designed suit via a matrix

CPS 7800 - Matrix configured - Suit				
CPS 7800 Configurator		R29650	1	D
CPS 7800 - Blue/Orange Suit				
CPS 7800, size S	150 - 165cm	Matrix	1	D
CPS 7800, size M	160 - 175cm	Matrix	1	D
CPS 7800, size L	170 - 185cm	Matrix	1	D
CPS 7800, size XL	180 - 195cm	Matrix	1	D
CPS 7800, size XXL	190 - 205cm	Matrix	1	D
CPS 7800 - Face Connection				
Face cuff (gas-tight)	No face mask attached to suit	Matrix	1	D
Mask Panorama Nova P-Triplex	Positive pressure mask with glass visor	Matrix	1	D
Mask Panorama Nova RA-Triplex	Filter mask with glass visor	Matrix	1	D
CPS 7800 - Integrated Footwear				
Boots PVC, size 9		Matrix	1	D
Boots PVC, size 9.5		Matrix	1	D
Boots PVC, size 10.5	Safety boots with steel toe and good resistance to perforation & certain chemicals.	Matrix	1	D
Boots PVC, size 11.5		Matrix	1	D
Boots PVC, size 13		Matrix	1	D
Socks, size 7.5-9.5	Integrated socks instead of boots so boots can be changed easily as required. Recommend the use of boot covers found in accessories	Matrix	1	D
Socks, size 9.5-12		Matrix	1	D
Socks, size 12-14		Matrix	1	D
Sock cover	To slip easily into the boots when wearing a suit with integrated socks.	R61018	1	D

PERSONAL PROTECTIVE EQUIPMENT

PRODUCT	DESCRIPTION	PART NO	PACKAGING UNIT	CATEGORY
CPS 7800 - Integrated Gloves				
Gloves Barrier+Tricotril, Size 10	Best chemical resistant inner barrier glove & outer kevlar cut resistant glove. Single use only	Matrix	1	D
Gloves Barrier+Tricotril, Size 11		Matrix	1	D
Gloves Butyl, size 9	Lowest chemical resistance but reusable (optional Tricotril or K-mex overglove for good cut resistance)	Matrix	1	D
Gloves Butyl, size 10		Matrix	1	D
Gloves Butyl, size 11		Matrix	1	D
CPS 7800 - Over & Under Gloves				
Overgloves Tricotril, Size 10 (pair)	High cut protection from Kevlar, high mechanical resistance, good grip	Matrix	1	D
Overgloves Tricotril, Size 11 (pair)		Matrix	1	D
Overgloves K-Mex Gigant, Size 14 (pair)	High cut protection from Kevlar, high wearing comfort, wrist protection	Matrix	1	D
Cotton gloves (Pair)	To wear inside the gloves	Matrix	1	D
CPS 7800 - External Air Supply & Cooling				
Preparing suit for Regulation valve PT 120 L (assembling ventilation loops)	Preparation for ventilation so it can be added at a later date	Matrix	1	D
Regulation Valve PT 120	Pass-through for cooling	Matrix	1	D
Regulation Valve cover		Matrix	1	D
CPS 7800 - Accessories				
Braces	Allows shorter people to use larger suits	Matrix	1	D
Transport Bag	Duffle Bag	Matrix	1	D
CPS Storage and Transportation Bag	Foldable bag	Matrix	1	D
Storage box	Blue with flap lid, stackable	Matrix	1	D
Grease Sticks	Set of 2 to lubricate zip	R27494	1	D
CPS Hanger	Hanger in T-form (flexible)	R54746	1	D
Bell Hanger	Stainless steel bell shaped hanger	R33299	1	D
CPS 7800 - Customer Marking				
Customized marking on right arm, front side	In blue, white or reflective silver	Matrix	1	D
Customized marking on left arm, front side		Matrix	1	D
Customized marking on right arm, back side		Matrix	1	D
Customized marking on left arm, back side		Matrix	1	D
Customized marking on right upper leg		Matrix	1	D
Customized marking on left upper leg		Matrix	1	D

*Incl. means this accessory can be Included at no additional cost when ordered on a matrix. Other part numbers must be added separately.

Dräger CPS 7900 Gas-Tight Suit

Tailor-made for use under extreme conditions: The gas-tight Dräger CPS 7900 provides excellent protection against industrial chemicals, biological agents, and other toxic substances. Its innovative material qualifies the CPS 7900 equally well for work in explosive areas and for handling cryogenic substances.



Place You Put Your Faith

Anti-fog disk (optional)

- No fogging – without pretreatment
- Large viewing window offers a nearly natural field of view

Zipper on the side

- Choose between opening from the top or bottom
- Cover flap with press studs or hook-and-loop fastener
- Especially suited to the needs of emergency teams

RV PT 120 L regulation valve (optional)

- Connection to an external breathing air source
- Adjustable ventilation rate
- Available with automatic switch-over between SCBA and external air source upon request

New backpack

- Combinable with all known PA cylinder combinations and closed-circuit devices

Gas-tight safety gloves (attachable to the suit without tools)

- Or with the new EN combination (laminated glove and Tricotril)

Integrated safety boots

- Easy to replace
- Attached to the suit
- Or gas-tight integrated socks

D-4558-2010

PERSONAL PROTECTIVE EQUIPMENT

PRODUCT	DESCRIPTION	PART NO	PACKAGING UNIT	CATEGORY
---------	-------------	---------	----------------	----------

CPS 7900 - REUSABLE SUIT

CPS 7900 Preconfigured Version

The CPS 7900 is a gas tight full encapsulated suit with a 5 layer design called Dmex material. It provides excellent protection against a broad range of substances and can be used in explosive areas.



Shelf Life - 15 years

Maintenance - Every Year or every 2nd year when stored in the Transportation & Storage Bag that the suit comes in. Original & sealed suits don't require testing for the first 5 years.

Lead Times - Typically 3 weeks for the preconfigured suits

CPS 7900 - Preconfigured				
CPS 7900 size S, boots size 9, Butyl gloves size 10		R58346	1	D
CPS 7900 size M, boots size 9, Butyl gloves size 10		R58347	1	D
CPS 7900 size L, boots size 12, Butyl gloves size 10	Orange, Zipper closes at top, anti-fog visor, pressure gauge holder, height adjustment, 2 grease sticks & CPS Storage and Transportation Bag.	R58348	1	D
CPS 7900 size XL, boots size 12, Butyl gloves size 11	Preconfigured suit, no other options possible	R58349	1	D
CPS 7900 size XXL, boots size 15, Butyl gloves size 11		R58350	1	D
CPS 7900 - Over & Under Gloves				
Overgloves Tricotril, Size 10 (pair)	High cut protection from Kevlar, high mechanical resistance, good grip	R55968	1	D
Overgloves Tricotril, Size 11 (pair)		R55966	1	D
Overgloves K-Mex Gigant, Size 14 (pair)	High cut protection from Kevlar, high wearing comfort, wrist protection	R55969	1	D
Cotton gloves (Pair)	To wear inside the gloves	R50972	1	D
CPS 7900 - Accessories				
Outer visor (set of 10)	Scratch protection	R57859	1	D
Storage box	Blue with flap lid, stackable	T51525	1	D
Grease Sticks	Set of 2 to lubricate zip	R27494	1	D
CPS Hanger	Hanger in T-form (flexible)	R54746	1	D
Bell Hanger	Stainless steel bell shaped hanger	R33299	1	D

Customisable suit with more options available on next page

PERSONAL PROTECTIVE EQUIPMENT

PRODUCT	DESCRIPTION	PART NO	PACKAGING UNIT	CATEGORY
---------	-------------	---------	----------------	----------

CPS 7900 - REUSABLE SUIT

CPS 7900 - Matrix Configured Version

The CPS 7900 is a gas tight full encapsulated suit with a 5 layer design called Dmex material. It provides excellent protection against a broad range of substances and can be used in explosive areas.



Shelf Life - 15 years

Maintenance - Every Year or every 2nd year when stored in the optional Transportation & Storage Bag.

Original & sealed suits don't require testing for the first 5 years.

Lead Times - Typically 8 weeks for a custom designed suit

CPS 7900 - Matrix configured - Suit				
CPS 7900 Training Configurator		R29500	1	D
CPS 7900 - Blue/Orange Suit				
CPS 7900, size S	150 - 165cm	Matrix	1	D
CPS 7900, size M	160 - 175cm	Matrix	1	D
CPS 7900, size L	170 - 185cm	Matrix	1	D
CPS 7900, size XL	180 - 200cm	Matrix	1	D
CPS 7900, size XXL	195 - 210cm	Matrix	1	D
CPS 7900 - Zip Cover Flap				
Single flap with velcro		Matrix	1	D
Single flap with buttons		Matrix	1	D
CPS 7900 - Integrated Footwear				
Boots Nitril-P, size 9		Matrix	1	D
Boots Nitril-P, size 9.5		Matrix	1	D
Boots Nitril-P, size 10.5	Specially for fire brigades. Excellent resistance to cuts, abrasion and a wide range of chemicals. Antistatic, heat resistant up to 250°C for 1 hour.	Matrix	1	D
Boots Nitril-P, size 11.5		Matrix	1	D
Boots Nitril-P, size 13		Matrix	1	D
Boots Nitril-P, size 14		Matrix	1	D
Socks, size 7.5-9.5	Integrated socks instead of boots so boots can be changed easily as required. Recommend the use of boot covers found in accessories	Matrix	1	D
Socks, size 9.5-12		Matrix	1	D
Socks, size 12-14		Matrix	1	D
Sock cover	To slip easily into the boots when wearing a suit with integrated socks.	R61018	1	D

PERSONAL PROTECTIVE EQUIPMENT

PRODUCT	DESCRIPTION	PART NO	PACKAGING UNIT	CATEGORY
CPS 7900 - Integrated Gloves				
Gloves Barrier+Tricotril, Size 10	Inner chemical resistant barrier glove & outer kevlar cut resistant glove. Single use only	Matrix	1	D
Gloves Barrier+Tricotril, Size 11		Matrix	1	D
Gloves FKM/Butyl, Size 9		Matrix	1	D
Gloves FKM/Butyl, Size 10	Lower chemical resistance but reusable (optional Tricotril or K-mex overglove for good cut resistance)	Matrix	1	D
Gloves FKM/Butyl, Size 11		Matrix	1	D
Arm Cuffs (gas tight)	Internal seal to protect wearer in-case of glove leak	Matrix	1	D
CPS 7900 - Over & Under Gloves				
Overgloves Tricotril, Size 10 (pair)	High cut protection from Kevlar, high mechanical resistance, good grip	Matrix	1	D
Overgloves Tricotril, Size 11 (pair)		Matrix	1	D
Overgloves K-Mex Gigant, Size 14 (pair)	High cut protection from Kevlar, high wearing comfort, wrist protection	Matrix	1	D
Cotton gloves (Pair)	To wear inside the gloves	Matrix	1	D
CPS 7900 - External Air Supply & Cooling				
Preparing suit for Regulation valve PT 120 L (assembling ventilation loops)	Preparation for ventilation so it can be added at a later date	Matrix	1	D
Regulation Valve PT 120 & Ventilation Loops	pass-through for cooling and breathing	Matrix	1	D
Air-Connect	pass-through for breathing only	Matrix	1	D
Y-Piece Switch-Over Valve (analog)		Matrix	1	D
Automatic Switch-Over Valve (digital)	PSS 7000/5000/3000	Matrix	1	D
Automatic Switch-Over Valve (digital)	PAS and other PSS	Matrix	1	D
Adapter Male to Female Coupling	to connect LDV or any male SCBA coupling	Matrix	1	D
Adapter Male to Male Coupling	to connect any female SCBA coupling	Matrix	1	D
CPS 7900 - Matrix configured - Accessories				
Outer visor (set of 10)	Scratch protection	Matrix	1	D
Anti-Fog visor		Matrix	1	D
Pressure gauge holder	Allows easier view of gauge in suit	Matrix	1	D
Height Adjustment	Allows shorter people to use larger suits	Matrix	1	D
D-Connect on left hip	Fitting for gas meters, tools, ropes	Matrix	1	D
D-Connect on right hip	Fitting for gas meters, tools, ropes	Matrix	1	D
CPS Storage and Transportation Bag	Comes with the Suit	Matrix	1	D
Storage box	Blue with flap lid, stackable	Matrix	1	D
Grease Sticks	Set of 2 to lubricate zip	R27494	1	D

PERSONAL PROTECTIVE EQUIPMENT

PRODUCT	DESCRIPTION	PART NO	PACKAGING UNIT	CATEGORY
Backpack pad	For use with BG4	Matrix	1	D
CPS Hanger	Hanger in T-form (flexible)	R54746	1	D
Bell Hanger	Stainless steel bell shaped hanger	R33299	1	D
CPS 6800 - Matrix configured - Customer Marking				
Customized marking on sleeve		Matrix	1	D
Customized marking on backpack		Matrix	1	D
Customized marking on chest	In blue, white or reflective silver	Matrix	1	D
Customized marking on upper leg		Matrix	1	D
Customized marking on left upper arm		Matrix	1	D

*Incl. means this accessory can be Included at no additional cost when ordered on a matrix. Other part numbers must be added separately.



Place You Put Your Faith

PERSONAL PROTECTIVE EQUIPMENT

PRODUCT	DESCRIPTION	PART NO	PACKAGING UNIT	CATEGORY
---------	-------------	---------	----------------	----------

CPS 7900 - REUSABLE TRAINING SUIT

CPS 7900 - Matrix Configured Version

The CPS 7900 is a gas tight full encapsulated suit with a 5 layer design called Dmex material. It provides excellent protection against a broad range of substances and can be used in explosive areas.



The CPS 6900/7900 Training is a training suit for the CPS 6900 and CPS 7900.

The training suit is not gas-tight, the seams are not welded, so that the suit does not offer any protection. It is only suitable for training exercises without real hazardous substances. The suit is distinguishable from the Dräger CPS 6900 and CPS 7900 because of the other material (blue Umex) and it is clear marked as a training suit.

Lead Times - Typically 8 weeks for a custom designed suit via a matrix.

CPS 7900 - Matrix configured - Suit				
CPS 7900 Training Configurator			R29511	1 D
CPS 7900 - Suit				
CPS 7900, size S	150 - 165cm	Matrix	1	D
CPS 7900, size M	160 - 175cm	Matrix	1	D
CPS 7900, size L	170 - 185cm	Matrix	1	D
CPS 7900, size XL	180 - 195cm	Matrix	1	D
CPS 7900, size XXL	190 - 205cm	Matrix	1	D
CPS 7900 - Zip Cover Flap				
Single flap with velcro		Matrix	1	D
Single flap with buttons		Matrix	1	D
CPS 7900 - Integrated Footwear				
Boots PVC, size 9		Matrix	1	D
Boots PVC, size 9.5		Matrix	1	D
Boots PVC, size 10.5	Safety boots with steel toe and good resistance to perforation & certain chemicals	Matrix	1	D
Boots PVC, size 11.5		Matrix	1	D
Boots PVC, size 13		Matrix	1	D
Socks, size 7.5-9.5	Integrated socks instead of boots so boots can be	Matrix	1	D
Socks, size 9.5-12	changed easily as required. Recommend the use of	Matrix	1	D
Socks, size 12-14	boot covers found in accessories	Matrix	1	D
Sock cover	To slip easily into the boots when wearing a suit with integrated socks.	R61018	1	D

PERSONAL PROTECTIVE EQUIPMENT

PRODUCT	DESCRIPTION	PART NO	PACKAGING UNIT	CATEGORY
CPS 7900 - Integrated Gloves				
Gloves Barrier+Tricotril, Size 10	Best chemical resistant inner barrier glove & outer	Matrix	1	D
Gloves Barrier+Tricotril, Size 11	kevlar cut resistant glove. Single use only	Matrix	1	D
Gloves Butyl, size 9		Matrix	1	D
Gloves Butyl, size 10	Lowest chemical resistance but reusable (optional	Matrix	1	D
Gloves Butyl, size 11	Tricotril or K-mex overglove for good cut resistance)	Matrix	1	D
Arm Cuffs (gas tight)	Internal seal to protect wearer in-case of glove leak	Matrix	1	D
CPS 7900 - Over & Inner Gloves				
Overgloves Tricotril, Size 10 (pair)	High cut protection from Kevlar, high mechanical	Matrix	1	D
Overgloves Tricotril, Size 11 (pair)	resistance, good grip	Matrix	1	D
Overgloves K-Mex Gigant, Size 14 (pair)	High cut protection from Kevlar, high wearing	Matrix	1	D
Cotton gloves (Pair)	comfort, wrist protection To wear inside the gloves	Matrix	1	D
CPS 7900 - External Air Supply & Cooling				
Preparing suit for Regulation valve PT 120 L (assembling ventilation loops)	Preperation for ventilation so it can be added at a later date	Matrix	1	D
Regulation Valve PT 120	pass-through for cooling and breathing	Matrix	1	D
Air-Connect	pass-through for breathing only	Matrix	1	D
Y-Piece Switch-Over Valve (analog)		Matrix	1	D
Automatic Switch-Over Valve (digital)	PSS 7000/5000/3000	Matrix	1	D
Automatic Switch-Over Valve (digital)	PAS and other PSS	Matrix	1	D
Adapter Male to Female Coupling	to connect LDV or any male SCBA coupling	Matrix	1	D
Adapter Male to Male Coupling	to connect any female SCBA coupling	Matrix	1	D
CPS 7900 - Accessories				
Outer visor (set of 10)	Scratch protection	Matrix	1	D
Anti-Fog-Visor		Matrix	1	D
Height Adjustment	Allows shorter people to use larger suits	Matrix	1	D
D-Connect on left hip	Fitting for gas meters, tools, ropes	Matrix	1	D
D-Connect on right hip	Fitting for gas meters, tools, ropes	Matrix	1	D
CPS Storage and Transportation Bag	Foldable bag	Matrix	1	D
Storage box	Blue with flap lid, stackable	Matrix	1	D
Backpack pad	For use with the BG4	Matrix	1	D
Grease Sticks	Set of 2 to lubricate zip	R27494	1	D
CPS Hanger	Hanger in T-form (flexible)	R54746	1	D
Bell Hanger	Stainless steel bell shaped hanger	R33299	1	D

PERSONAL PROTECTIVE EQUIPMENT

PRODUCT	DESCRIPTION	PART NO	PACKAGING UNIT	CATEGORY
CPS 7900 - Customer Marking				
Customized marking on sleeve		Matrix	1	D
Customized marking on backpack		Matrix	1	D
Customized marking on chest	In blue, white or reflective silver	Matrix	1	D
Customized marking on upper leg		Matrix	1	D
Customized marking on left upper arm		Matrix	1	D

*Incl. means this accessory can be Included at no additional cost when ordered on a matrix. Other part numbers must be added separately.



Place You Put Your Faith

PERSONAL PROTECTIVE EQUIPMENT

Suit Material options & their resistance to chemical permeation according to EN 943-2:2002

	D-mex	Umex	Zytron 500
Acetone	6	0	6
Acetonitrile	6	0	6
Ammonia	6	6	6
Carbon disulphide	6	0	6
Chlorine	6	6	6
Dichloromethane	6	0	6
Diethylamine	6	0	6
Ethyl acetate	6	0	6
Hexane	6	6	6
Hydrogen chloride	6	4	6
Hydrofluoric acid 70%	4	0	6
Methanol	6	0	6
n-heptane	6	6	6
Sodium hydroxide 40 %	6	6	6
Sulphuric acid 96 %	6	2	6
Tetrahydrofurane	6	0	6
Toluene	6	0	6

Class 0: Immediate	0	D-mex - CPS 7000 series
Class 1: > 10 minutes	1	Umex - CPS 6000 series
Class 2: > 30 minutes	2	Zytron - CPS 5000 series
Class 3: > 60 minutes	3	
Class 4: > 120 minute	4	
Class 5: > 240 minutes	5	
Class 6: > 480 minutes	6	

PERSONAL PROTECTIVE EQUIPMENT

PRODUCT	DESCRIPTION	PART NO	PACKAGING UNIT	CATEGORY
---------	-------------	---------	----------------	----------

GLOVES

Overgloves



Tricotril® Overgloves made out of cut protective Para aramid (Kevlar) according to EN 388/374 - category III
Color: green, Length: approx. 350 mm. high cut protection, high mechanical resistance, sure grip due to palm profile

1. Overglove Tricotril	size 10 (pair)	R55968	1	D
1. Overglove Tricotril	size 11 (pair)	R55966	1	D
Rubber ring		R51358	1	D

Overgloves made out of cut protective Para aramid (Kevlar) according to EN 388 - category III
Color: yellow, Length: approx. 360 mm. high wearing comfort, wrist protection

2. Overglove K-MEX GIGANT	size 14 (pair)	R55969	1	D
---------------------------	----------------	--------	---	---

Innergloves

Cotton glove (pair)	To be used inside chemical/gas suits	R50972	1	D
---------------------	--------------------------------------	--------	---	---

Replacement Glove Combinations

These are the various glove combinations that can be supplied to replace damaged gloves. See the next page for a chemical resistance guide

Glove comb. Barrier+Tricotril

3. Glove Barrier / Tricotril	size 10 (pair)	R63003	1	D
3. Glove Barrier / Tricotril	size 11 (pair)	R63004	1	D
3. Glove Barrier / Tricotril + Cuff	size 10 (pair)	R63005	1	D
3. Glove Barrier / Tricotril + Cuff	size 11 (pair)	R63006	1	D

FKM/Butyl Gloves

4. Glove FKM(Viton)/Butyl	size 9 (pair)	R55762	1	D
4. Glove FKM(Viton)/Butyl	size 10 (pair)	R55531	1	D
4. Glove FKM(Viton)/Butyl	size 11 (pair)	R55761	1	D

Butyl Gloves

4. Glove Butyl	size 9 (pair)	R55538	1	D
4. Glove Butyl	size 10 (pair)	R53531	1	D
4. Glove Butyl	size 11 (pair)	R53560	1	D

FKM Gloves

4. Glove FKM(Viton)	size 9 (pair)	R55537	1	D
4. Glove FKM(Viton)	size 10 (pair)	R53776	1	D
4. Glove FKM(Viton)	size 11 (pair)	R53554	1	D

PERSONAL PROTECTIVE EQUIPMENT

Glove options & their resistance to chemical permeation according to EN 943-2:2002

	BUTYL glove	FKM (VITON) glove	FKM(VITON)/ BUTYL glove	Barrier/Tricotril Glove
Acetone	6	0	6	6
Acetonitrile	6	1	6	6
Ammonia	6	6	6	6
Carbon disulphide	2	6	6	6
Chlorine	1	6	6	6
Dichloromethane	1	4	4	3
Diethylamine	1	4	3	6
Ethyl acetate	4	1	4	6
Hydrogen chloride	6	6	6	6
Methanol	6	4	6	6
n-heptane	1	6	6	6
Sodium hydroxide 40 %	6	6	6	6
Sulphuric acid 96 %	4	6	6	6
Tetrahydrofurane	1	1	1	6
Toluene	1	6	6	6

Class 0: Immediate	0
Class 1: > 10 minutes	1
Class 2: > 30 minutes	2
Class 3: > 60 minutes	3
Class 4: > 120 minute	4
Class 5: > 240 minutes	5
Class 6: > 480 minutes	6

PERSONAL PROTECTIVE EQUIPMENT

PRODUCT	DESCRIPTION	PART NO	PACKAGING UNIT	CATEGORY
---------	-------------	---------	----------------	----------

BOOTS

Boots



Safety boots according to EN 20345 S5

1. Boots PVC (pair)	size 9	R52653	1	D
1. Boots PVC (pair)	size 9.5	R55474	1	D
1. Boots PVC (pair)	size 10.5	R55477	1	D
1. Boots PVC (pair)	size 11.5	R52656	1	D
1. Boots PVC (pair)	size 13	R55413	1	D

Safety boots according to EN 20345 S5 SRA ideal for work in hazardous zones. ESD boots guarantee an extremely low electrical resistance under any conditions in order to prevent a strong, uncontrolled electrostatic discharge.

1. Boots ESD PVC (pair)	size 6.5	R62441	1	D
1. Boots ESD PVC (pair)	size 7.5	R62463	1	D
1. Boots ESD PVC (pair)	size 8	R62464	1	D
1. Boots ESD PVC (pair)	size 9	R62465	1	D
1. Boots ESD PVC (pair)	size 9.5	R62466	1	D
1. Boots ESD PVC (pair)	size 10.5	R62467	1	D
1. Boots ESD PVC (pair)	size 11.5	R62468	1	D
1. Boots ESD PVC (pair)	size 12.5	R62469	1	D
1. Boots ESD PVC (pair)	size 13.5	R62470	1	D

Specially for fire brigades. Safety boots according to EN 20345 und 15090.

2. Boots Nitril-P (pair)	size 9	R56863	1	D
2. Boots Nitril-P (pair)	size 9.5	R56864	1	D
2. Boots Nitril-P (pair)	size 10.5	R56865	1	D
2. Boots Nitril-P (pair)	size 11.5	R56866	1	D
2. Boots Nitril-P (pair)	size 13.5	R56867	1	D
2. Boots Nitril-P (pair)	size 14	R56868	1	D

To slip easily into the boots when wearing a suit with integrated socks. Made of Tyvek®.

Integrated Sock cover	Put over suit sock	R61018	1	D
-----------------------	--------------------	--------	---	---

PERSONAL PROTECTIVE EQUIPMENT

Boot options & their resistance to chemical permeation according to EN 943-2:2002

	PVC Boots	Nitrile Boots
Acetone		3
Acetonitrile		3*
Ammonia	6	6
Carbon disulphide		3
Caustic Soda 40 %		6
Chlorine	6	6
Dichloromethane		2
Diethylamine		4
Ethyl acetate		4
Hydrogen chloride	6	6
Methanol		3*
n-heptane	4	6
Sulphuric acid 96 %	6	6
Tetrahydrofurane		4
Toluene		4

* Testing according to EN 374-3 carried out by independent certification institutes, stopped when protection class 3 reached

Class 1: > 10 minutes	1
Class 2: > 30 minutes	2
Class 3: > 60 minutes	3
Class 4: > 120 minute	4
Class 5: > 240 minutes	5
Class 6: > 480 minutes	6

PERSONAL PROTECTIVE EQUIPMENT

PRODUCT	DESCRIPTION	PART NO	PACKAGING UNIT	CATEGORY
---------	-------------	---------	----------------	----------

HELMETS



- Dräger HPS 3500 – multi-Functional and universal safety helmet especially designed for the demands of emergency-teams, In search and rescue missions, for forest and bush firefighting, road accidents, height rescue and any kind of technical support operations in emergency situations
- High-tech materials provide an optimal head protection with very low weight
- Excellent wearing comfort due to comfortable interior design with ventilation system for optimal climate inside the helmet sealable to protect against penetration of water, flying shavings or sparks
- Individual adjustment of the head size by easy to operate adjustment wheel
- Various easy to adapt accessories for different applications available
- Available as set Incl. robust safety goggles with pinlock-technology (goggles accord. To EN 166 and EN 14458) or as version without goggles

e.g. For applications where a visor as face protection is preferred

HPS 3500 Firefighters Helmet				
Set Including safety goggles – available in 8 different PAINTED colours				
Dräger HPS 3500 Set	Red	R62651	1	D
Dräger HPS 3500 Set	White	R62652	1	D
Dräger HPS 3500 Set	Yellow	R62653	1	D
Dräger HPS 3500 Set	Black	R62654	1	D
Dräger HPS 3500 Set	Blue	R62655	1	D
Dräger HPS 3500 Set	luminescent	R62656	1	D
Dräger HPS 3500 Set	Flourescent Yellow	R62657	1	D
Dräger HPS 3500 Set	Flourescent Orange	R62658	1	D
WITHOUT safety goggles – available in 8 different PAINTED colours				
Dräger HPS 3500	Red	R62640	1	D
Dräger HPS 3500	White	R62641	1	D
Dräger HPS 3500	Yellow	R62642	1	D
Dräger HPS 3500	Black	R62643	1	D
Dräger HPS 3500	Blue	R62644	1	D
Dräger HPS 3500	luminescent	R62645	1	D
Dräger HPS 3500	Flourescent Yellow	R62646	1	D
Dräger HPS 3500	Flourescent Orange	R62647	1	D
Helmet in basic design (not painted/mass dyed) as set (with protective goggles)				
Dräger HPS 3500 Set	Red	R62659	1	D
Dräger HPS 3500 Set	White	R62660	1	D
Dräger HPS 3500 Set	Yellow	R62661	1	D
Helmet in basic design (not painted/mass dyed) as set (WITHOUT protective goggles)				
Dräger HPS 3500	Red	R62648	1	D
Dräger HPS 3500	White	R62649	1	D
Dräger HPS 3500	Yellow	R62650	1	D

PERSONAL PROTECTIVE EQUIPMENT

PRODUCT	DESCRIPTION	PART NO	PACKAGING UNIT	CATEGORY
Accessories and Spare Parts				
Goggles/Visors				
Safety goggles (WITH SILICONE STRAP) (EN 166/ EN 14458)	(in case of HPS 3500 Sets Included in scope of delivery)	R58424	1	D
PC (Polycarbonate)-Visor, clear (EN 166)	Eye protection to wear with helmet - as alternative to safety goggles	R58432	1	D
Mesh visor (EN 1731) To protect eyes against flying shavings, e.g. when working with wood		R58431	1	D
Electro-Visor (EN 166) To protect eyes against electric arcs when working in electric installations carrying heavy currents		R58433	1	D
Lamp holders / lamps				
Lamp holder for Dräger PX1-Lamps Made of high-temperature-resistant plastic		R58566	1	D
Helmet lamp Dräger PX 1 LED Lamp with ATEX-approval in longlife LED-Technology		R62350	1	D
Reflective stripes				
Self-adhesive, for individual design of helmets Available in 3 different colours:				
Reflective stripes, red		R58426	1	D
Reflective stripes, yellow		R58427	1	D
Reflective stripes, grey-silver		R58428	1	D
Further accessories				
Neck curtain HPS 3500 Nomex Neck curtain in scarf-design, made of Nomex-material		R58434	1	D
Ear muffs (EN 352-3) Hearing protection, easy to adapt to helmet		R58430	1	D
Antifog spray for visors		R56542	1	D
Helmet pouch (for dust protection and transport)		R79282	1	D
Helmet bag, small (for transport and storage)		R58555	1	D

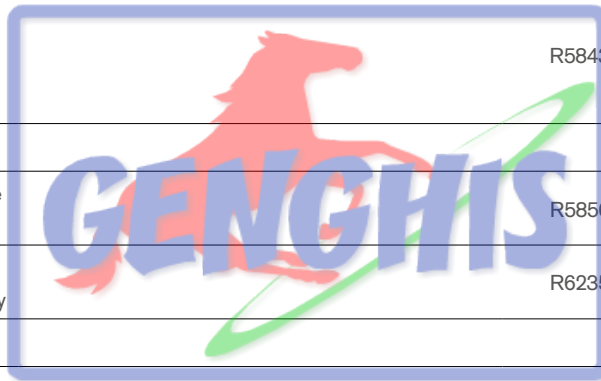

Place You Put Your Faith

PERSONAL PROTECTIVE EQUIPMENT

PRODUCT	DESCRIPTION	PART NO	PACKAGING UNIT	CATEGORY
---------	-------------	---------	----------------	----------



With integrated facial protection (clear), equipped with front plate in matt black, without integrated protective goggles, without mask adapter and without option to attach an external lamp. Integrated HPS 7000 helmet lamp can be retrofitted as an option.

HPS 7000 Basic Firefighters Helmets				
Dräger HPS 7000 BASIC (pho/mblack)	Photoluminescent, matt black front plate. Polysulfone visor, without reflective strips	R79170	1	F
Dräger HPS 7000 BASIC (white/mblack)	White, matt black front plate. Polysulfone visor, without reflective strips	R79171	1	F
Dräger HPS 7000 BASIC (red/mblack)	Red, matt black front plate. Polysulfone visor, without reflective strips	R79172	1	F
Dräger HPS 7000 BASIC (br yellow/mblack)	Bright yellow, matt black front plate. Polysulfone visor, without reflective strips	R79173	1	F
Dräger HPS 7000 BASIC (zi yellow/mblack)	Zinc yellow, matt black front plate. Polysulfone visor, without reflective strips	R79174	1	F
Dräger HPS 7000 BASIC (br orange/mblack)	Bright orange, matt black front plate. Polysulfone visor, without reflective strips	R79175	1	F
Dräger HPS 7000 BASIC (Signal blue/mblack)	Blue, matt black front plate. Polysulfone visor, without reflective strips	R79176	1	F
Dräger HPS 7000 BASIC (black/mblack)	Black, matt black front plate. Polysulfone visor, without reflective strips	R79177	1	F

PERSONAL PROTECTIVE EQUIPMENT

PRODUCT	DESCRIPTION	PART NO	PACKAGING UNIT	CATEGORY
---------	-------------	---------	----------------	----------



With integrated facial protection (clear) and protective goggles (clear), equipped with front plate in matt black or helmet colour, with mask adapter and option to attach an external lamp or the integrated HPS 7000 helmet lamp. Includes reflective strips on the helmet back

HPS 7000 Pro Firefighters Helmets				
Dräger HPS 7000 PRO (pho/mblack)	Photoluminescent, matt black front plate. Polysulfone visor, protective goggles, with reflective strips, excludes lamps	R79250	1	F
Dräger HPS 7000 PRO (white/mblack)	White, matt black front plate. Polysulfone visor, protective goggles, with reflective strips, excludes lamps	R79251	1	F
Dräger HPS 7000 PRO (red/mblack)	Red, matt black front plate. Polysulfone visor, protective goggles, with reflective strips, excludes lamps	R79252	1	F
Dräger HPS 7000 PRO (br yellow/mblack)	Bright yellow, matt black front plate. Polysulfone visor, protective goggles, with reflective strips, excludes lamps	R79253	1	F
Dräger HPS 7000 PRO (zi yellow/mblack)	Zinc yellow, matt black front plate. Polysulfone visor, protective goggles, with reflective strips, excludes lamps	R79254	1	F
Dräger HPS 7000 PRO (br orange/mblack)	Bright orange, matt black front plate. Polysulfone visor, protective goggles, with reflective strips, excludes lamps	R79255	1	F
Dräger HPS 7000 PRO (Signal blue/mblack)	Blue, matt black front plate. Polysulfone visor, protective goggles, with reflective strips, excludes lamps	R79256	1	F
Dräger HPS 7000 PRO (black/mblack)	Black, matt black front plate. Polysulfone visor, protective goggles, with reflective strips, excludes lamps	R79257	1	F
Dräger HPS 7000 CONFIGURATOR Size H1	Allows helmet to be configured to specific customer requirements. Matrix to be filled out and supplied at time of order	R79571	1	F
Dräger HPS 7000 CONFIGURATOR Size H2	Allows helmet to be configured to specific customer requirements. Matrix to be filled out and supplied at time of order	R79572	1	F

PERSONAL PROTECTIVE EQUIPMENT

PRODUCT	DESCRIPTION	PART NO	PACKAGING UNIT	CATEGORY
---------	-------------	---------	----------------	----------

COMMUNICATION SYSTEMS - PUSH TO TALK BUTTONS

Com-Control 400



The Dräger C-C400 is an easy to operate push-to-talk button which offers an easy voice transfer in all situations. The large surface of the Dräger C-C400 makes it the first choice, for operation in all cases even when wearing the device under protective clothing. The Dräger C-C400 allows the direct connection of a headset or mask communication to the radio unit.

The C-C400 is extremely stable, robust and waterproof to resist all operational conditions. Depending on the radio it can be ATEX approved to be used in potentially explosive environments. A belt clip is included in the delivery. The Dräger C-C400 is also available with a "Mushroom PTT" to be used under a CPS. The Mushroom PTT can be retrofitted as well by a certified service workshop.

Com-Control 440



The Dräger C-C440 is an easy to operate push-to-talk button which simplifies the communication via the tactical radio.

The large push-to-talk button of the Dräger C-C440 makes it the first choice for operations when wearing the device under protective clothing (e.g. chemical protection suit).

The 4 pole Nexus adaptor allows a flexible connection of a headset or mask communication to the radio unit. The C-C440 is extremely stable, robust and waterproof (MIL STD 810G and IP67) to resist all operational conditions. Depending on the radio, the unit can be ATEX approved for usage in potentially explosive environments. Order information and radio compatibilities shall be taken from the attached table.

Com-Control 500



The Dräger C-C500 can be combined with any type of Dräger headset. Thanks to the integrated microphone and speaker, the device can also be used without the upper unit (headset). The two large push-to-talk buttons allow an easy voice transfer, even when wearing the device under protective clothing. The C-C500 is extremely stable, robust and waterproof.

Depending on the radio it can be ATEX approved for use in potentially explosive environments.

The Dräger control units can be connected to over 400 different radios. Please use the order-code from the following table.

For Com-Control units for radios that you cannot find in the table please contact Dräger.

Com-Control 550



The Dräger C-C550 includes both an integrated microphone and speaker, which gives a flexibility of use as the device can be used with headset but also without a connected head-set. It eases the use of the tactical radio significantly. The two large push-to-talk buttons allow an easy voice transfer, even when wearing the device under protective clothing.

The C-C550 is extremely stable, robust and waterproof (MIL STD 810G and IP67) to resist all operational conditions. Depending on the radio, the unit can be ATEX approved for usage in potentially explosive environments. For Com-Control units for radios that you cannot find in the table please contact Dräger.

For part numbers and pricing please see the 'Communication Systems' folder in 'Sales info from Marketing' or contact the relevant product manager

PERSONAL PROTECTIVE EQUIPMENT

PRODUCT	DESCRIPTION	PART NO	PACKAGING UNIT	CATEGORY
---------	-------------	---------	----------------	----------

COMMUNICATION SYSTEMS - HELMET COMMUNICATION



Clear and reliable hands free communication. The headsets in the HC-series can be integrated with Dräger control units into various systems, improving safety and work efficiency. The devices can be used under respiratory equipment as they are equipped with highly reliable and voice-sensitive microphones.

The HC-headsets can be adapted to most types of helmets with the unique fastening strap. It is possible to mount the unit without any tools and the unique fastening strap is included.

Further optional adapters are available.

HC-1 COM



One speaker for all helmets with bone conductive microphone
 Speaker: One
 Compatibility: Dräger Com-Control 400/440 500/550
 Connector: Quick release plug (4 pole)

ATEX approved*:

Place You Put Your Faith

HC-1 COM*	coiled cable and long microphone arm	R35059	1	D
HC-1 COM*	straight flash-over proof cable and long microphone arm	R60904	1	D
HC-1 COM	coiled cable and short microphone arm	R35040	1	D
HC-1 COM	coiled cable and long microphone arm	R60910	1	D

HC-2 COM



Two speakers for all helmets with bone conductive microphone

Speaker: Two

Compatibility: Dräger Com-Control 400/440 500/550

Connector: Quick release plug (4 pole)

ATEX approved*:

HC-2 COM*	coiled cable	R35061	1	D
HC-2 COM*	straight flash-over proof cable	R60909	1	D
HC-2 COM	coiled cable	R35041	1	D

PERSONAL PROTECTIVE EQUIPMENT

PRODUCT	DESCRIPTION	PART NO	PACKAGING UNIT	CATEGORY
HC-E COM				
	One speaker for helmets with electronic microphone Speaker: One Compatibility: Dräger Com-Control 400/440 500/550 Connector: Quick release plug (4 pole) ATEX approved*:			
HC-E COM*	coiled cable	R35062	1	D
HC-E COM	coiled cable	R35042	1	D
HC-E COM	straight flash-over proof cable	R60911	1	D
Optional Brackets for adaptation to helmets				
Order one Base Part (for HPS 6200 you have the choice if left or right) and one adapter ring:				
Base part for adaptation to helmet HPS 7000 right and left		R79278		D
Base part for adaptation to helmet HPS 6200 right		R56825		D
Base part for adaptation to helmet HPS 6200 left		R56826		D
Adapter ring for communication sets Dräger COM		R56828		D
HC-1 fastening strap long		R60927		D
HC-1 fastening strap short		R60934		D
HC-1 adapter for the Gallet-helmet		R60928		D

Place You Put Your Faith

PERSONAL PROTECTIVE EQUIPMENT

PRODUCT	DESCRIPTION	PART NO	PACKAGING UNIT	CATEGORY
Accessories and Spare Parts				
Neck curtain Alu/Nomex HPS 7000		R79145	1	D
Neck curtain Nomex short HPS 7000		R79146	1	D
Neck protection Nomex, neck curtain, three-layer		R79147	1	D
HPS 7000 helmet lamp LED, integrated		R79013	1	D
For HPS 7000 and HPS 7000 PRO, to attach the integrated LED helmet lamp, order separately:				
E-kit front plate for HPS 7000 helmet lamp"		R79226	1	D
Helmet lamp Dräger PX 1 LED (120 Lumen)		R62350	1	D
Reflective strips, service grade		R79006	1	D
Adapter for Communication systems (Savox)		R56828	1	D
Helmet cover (for protection of helmet during hot fire training)	For protection of helmet during hot fire training	R79279	1	D
Helmet bag (for transport and storage of up to two helmets)	For transport and storage of up to two helmets	R58555	1	D
Helmet bag (simple cloth bag)	Simple cloth bag	R79282	1	D

Place You Put Your Faith

PERSONAL PROTECTIVE EQUIPMENT

PRODUCT	DESCRIPTION	PART NO	PACKAGING UNIT	CATEGORY
---------	-------------	---------	----------------	----------

THERMAL IMAGING CAMERA



UCF 6000/UCF 7000/UCF 8000/UCF 9000				
Camera Kits				
Dräger UCF 6000, 50 Hz-Version		8321127	1	D
Dräger UCF 7000, 50 Hz-Version		8327041	1	D
Dräger UCF 8000, 50 Hz-Version		8327042	1	D
Dräger UCF 9000, 50 Hz-Version		8327043	1	D
Accessories & Spare Parts				
Transport case	Robust plastic-case, padded inside	8321099	1	D
Neck strap	For carrying during operation	8323031	1	D
Retractable lanyard	For fixation on the Breathing Apparatus	8323032	1	D
Hand support loop	To hold the camera - as alternative to integrated camera handle	8323033	1	D
Lithium-Ion battery (with Ex-protection)	For operation of camera for up to 4 hours	8323075	1	D
Charger	For charging of Li-Ion batteries	8321247	1	D
Power supply (240V)	For desktop to battery charger	8316994	1	D
Truck charging kit	Consists of bracket and 12 -30 V-connection cable	8321110	1	D
Suck Tripod solution	e.g. to mount on truck roofs	8323070	1	D
Tripod	For positioning of camera	8321254	1	D
Universal clamp	e.g. to clamp on ladders	8321259	1	D
12 V-Adapter	For operations with tripod	on request	1	
12 V-power supply	For operations with tripod	8316994	1	D

PERSONAL PROTECTIVE EQUIPMENT

PRODUCT	DESCRIPTION	PART NO	PACKAGING UNIT	CATEGORY
---------	-------------	---------	----------------	----------

ESCAPE EQUIPMENT

ESCAPE UNITS – OXYGEN SELF-RESCUER

DRÄGER OXY 3000 MK II

The Dräger Oxy 3000 MK II is a rescue apparatus for respiratory protection, independent from ambient air, designed for use in environments where the person is in danger of toxication or there is less oxygen. The innovative Safety Eye is designed to keep an eye on safety. Providing immediate confirmation of operational readiness, this clear status window allows wearers to check for the presence of moisture and yellow KO2 fragments within the device on a daily basis.

The Dräger Oxy 3000 MK II supplies independent air for up to 30 minutes and offers a 10-year lifetime without maintenance.

Suitable for temperature classes T1-T4.

Approvals:

- EN 13794 - 89/686/EWG (Europe)
- AUS/NZS 1716 – MDG 3609 (Australia, New Zealand)
- EAC 019/2011 (Russia, Belarus, Kazakhstan)
- CA acc. to EN 13794 (Brazil)

Breathing connection: mouth piece with nose clip

Usage period: 30 minutes acc. to EN 13794

Gas-tight goggle is included in the device.

With the Dräger Oxy 3000 MK II you have the chance to choose between five different versions.

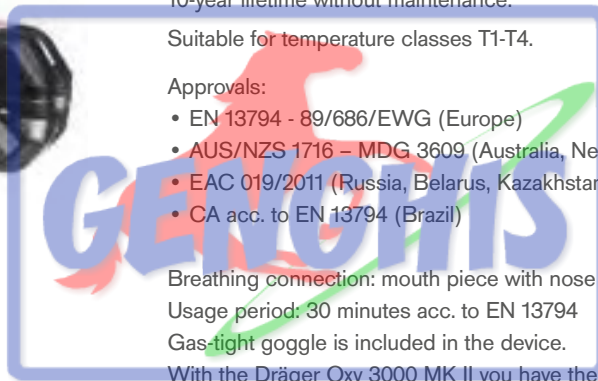

Place You Put Your Faith

Dräger Oxy 3000 MK II	Without support ring and abrasion protection	6305800	1
Dräger Oxy 3000 MK II	Hip worn without abrasion protection Hip belt is not included	6305805	1
Dräger Oxy 3000 MK II	Hip worn with abrasion protection Hip belt is not included	6305810	1
Dräger Oxy 3000 MK II	Shoulder worn without abrasion protection Shoulder belt is included	6305815	1
Dräger Oxy 3000 MK II	Shoulder worn with abrasion protection Shoulder belt is included	6305820	1

Training Unit



Training unit for Dräger Oxy 3000 MK II without KO2-cartridge and without starter to train the donning.
Hip belt is not included, without abrasion protection.

6307430 1

Dräger Oxy 3000 MK II T (Training unit)

Accessories



6305427 1

Abrasion protection

PERSONAL PROTECTIVE EQUIPMENT

PRODUCT	DESCRIPTION	PART NO	PACKAGING UNIT	CATEGORY
	With connection for abrasion protection	6305009	1	
Support ring for hip worn version				
Support ring for hip worn version	With connection for abrasion protection	6305189	1	
	With connection for abrasion protection	6305062	1	
Support ring for shoulder worn version				
Support ring for shoulder worn version	Without connection for abrasion protection	6305182	1	
		6733934	1	
Hip belt				
		6305415	1	
Shoulder belt				
Hand belt		6305419	1	
Bracket Dräger Oxy 3000/6000 MK II	The bracket may be used as wall- and vehicle- bracket	6305420	1	
	Simulation of the heated inhalation temperature for Dräger Oxy 3000/6000 MK II. Training units with breathing connection: mouse piece and nose clip	6307145	1	
Practice simulator Dräger Oxy 3000/6000 MK II Training				
		6306367	1	
Statue Dräger Oxy 3000/6000 MK II				
Spare Parts				
For the spare parts please refer to our spare part list(s) which you receive on request.				
Dräger Oxy 3000 MK II		E 1167.603	1	
Dräger Oxy 3000 MK II Training unit		E 1167.604		

PERSONAL PROTECTIVE EQUIPMENT

PRODUCT	DESCRIPTION	PART NO	PACKAGING UNIT	CATEGORY
---------	-------------	---------	----------------	----------

DRÄGER OXY 6000 MK II



The Dräger Oxy 6000 MK II is a rescue apparatus for respiratory protection, independent from ambient air, designed for use in environments where the person is in danger of toxication or there is less oxygen. The innovative Safety Eye is designed to keep an eye on safety. Providing immediate confirmation of operational readiness, this clear status window allows wearers to check for the presence of moisture and yellow KO2 fragments within the device on a daily basis.

The Dräger Oxy 6000 MK II supplies independent air for up to 60 minutes and offers a 10-year lifetime without maintenance.

Suitable for temperature classes T1-T4.

Approvals:

- EN 13794 - 89/686/EWG (Europe)
- AUS/NZS 1716 – MDG 3609 (Australia, New Zealand)
- SANS 10338
- EAC 019/2011 (Russia, Belarus, Kazakhstan)
- CA acc. to EN 13794 (Brazil)

Breathing connection: mouth piece with nose clip

Usage period: 60 minutes acc. to EN 13794

Gas-tight goggle is included in the device.

With the Dräger Oxy 6000 MK II you have the chance to choose between seven different versions.

Dräger Oxy 6000 MK II	Without support ring and abrasion protection	6306800	1
Dräger Oxy 6000 MK II	Hip worn without abrasion protection Hip belt is not included	6306805	1
Dräger Oxy 6000 MK II	Hip worn with abrasion protection Hip belt is not included	6306810	1
Dräger Oxy 6000 MK II	Shoulder worn without abrasion protection Shoulder belt is included	6306815	1
Dräger Oxy 6000 MK II	Shoulder worn with abrasion protection Shoulder belt is included	63 06820	1
Dräger Oxy 6000 MK II	Hand worn without abrasion protection Hand belt is included	6306830	1
Dräger Oxy 6000 MK II	Hand worn with abrasion protection Hand belt is included	6306825	1

Training Unit



Training unit for Dräger Oxy 6000 MK II without KO2-cartridge and without starter to train the donning.
Incl. shoulder belt, without abrasion protection

6307460 1

Dräger Oxy 6000 MK II T (Training unit)

Accessories



6306386 1

Abrasion protection

PERSONAL PROTECTIVE EQUIPMENT

PRODUCT	DESCRIPTION	PART NO	PACKAGING UNIT	CATEGORY
	With connection for abrasion protection	6305009	1	
Support ring for hip worn version				
Support ring for hip worn version	With connection for abrasion protection	6305189	1	
	With connection for abrasion protection	6305062	1	
Support ring for shoulder worn version				
Support ring for shoulder worn version	Without connection for abrasion protection	6305182	1	
		6733934	1	
Hip belt				
		6305415	1	
Shoulder belt				
Hand belt		6305419	1	
Bracket Dräger Oxy 3000/6000 MK II	The bracket may be used as wall- and vehicle- bracket	6305420	1	
	Simulation of the heated inhalation temperature for Dräger Oxy 3000/6000 MK II. Training units with breathing connection: mouse piece and nose clip	6307145	1	
Practice simulator Dräger Oxy 3000/6000 MK II Training				
		6306367	1	
Statue Dräger Oxy 3000/6000 MK II				
Spare Parts				
For the spare parts please refer to our spare part list(s) which you receive on request.				
Dräger Oxy 6000 MK II		E 1167.605	1	
Dräger Oxy 6000 MK II Training unit		E 1167.606		

PERSONAL PROTECTIVE EQUIPMENT

PRODUCT	DESCRIPTION	PART NO	PACKAGING UNIT	CATEGORY
---------	-------------	---------	----------------	----------

DRÄGER OXY K SERIES



Escape units on the basis of solid oxygen.

Respiratory protective device for use in hazardous areas operating independently of the ambient air for self-rescue.

Oxygen self-rescuers of the Dräger Oxy K series supply independent air for up to 30 minutes and offer a 10-year lifetime without maintenance.

Suitable for the temperature classes T1 – T4.

Approvals:

- Dräger Oxy K 30 S: EN 13794
- Dräger Oxy K 30 HS/HW: EN 13794, DIN 58639, SOLAS and MED

Breathing connection: mouth piece with nose clip

Usage period: 60 minutes acc. to EN 13794

Gas-tight goggle is included in the device.

With the Dräger Oxy 6000 MK II you have the chance to choose between seven different versions.

Dräger Oxy K 30 S

Breathing connection: mouth piece with nose clip
Standard with shoulder strap and gas-tight goggle.
Usage period according to EN 13794.

6303000

1

Dräger Oxy K 30 HS

Breathing connection: hood
Complete with shoulder strap.
Usage period: 30 minutes according to
DIN 58639 / EN 13794 / MED / SOLAS

6304700

1



Dräger Oxy K 30 HW

Breathing connection: hood
Complete with wall holder and inlying neck strap.
Usage period: 30 minutes according to
DIN 58639 / EN 13794 / MED / SOLAS

6304600

1

Training Units

Training unit for Dräger Oxy K series, but without KO -cartridge and without starter to train the donning.

Dräger Oxy K 30 ST, incl. shoulder belt

6303001

Dräger Oxy K 30 HWT, incl. wall holder

6304601

Dräger Oxy K 30 HST, incl. shoulder belt

6304701

Accessories

Gas tight protection goggles

6303670

1

Chest belt-set

Worn around the chest to fix in addition to the chest.

6301956

Reflecting stickers

For Dräger Oxy K.

6303613

Sticker

For individual labelling (20 pcs each set).

6303611

20

PERSONAL PROTECTIVE EQUIPMENT

PRODUCT	DESCRIPTION	PART NO	PACKAGING UNIT	CATEGORY
Shoulder belt	Partly already included in the scope of delivery of the basic unit.	6304521	1	
Belt clip	To fix the shoulder worn device on the belt.	6304664	1	
Practise simulator unit for Oxy K Training Units	Simulation of the heated inhalation temperature for Dräger Oxy K. Training units with breathing connection: mouse piece and nose clip.	6304699	1	
Spare Parts				
For the spare parts please refer to our spare part list(s) which you receive on request.				
Dräger Oxy K		E 1167.400e	1	
Dräger Oxy K Training units		E 1167.482e		



Place You Put Your Faith

PERSONAL PROTECTIVE EQUIPMENT

PRODUCT	DESCRIPTION	PART NO	PACKAGING UNIT	CATEGORY
---------	-------------	---------	----------------	----------

CLOSED CIRCUIT BREATHING APPARATUS



- Approvals: EN 145, NIOSH/MSHA (USA) Approval No.: TC-13F-341 9/01/1995
- WORKCOVER AUTHORITY (Monitron SCBA Warning Module) Approval No. : Ex ia I4071 Issued: 14/11/1994
- Bodyguard II Explosive atmosphere approval Certificate No. IECEx TSA 0418 (issued 01/11/2004)
- NSW Dept of Mineral Resources, Mine Safety Unit Test Report, No. 94/1016 (16/08/94) with and without springs,
- According to Aus. Standards AS1716-1994 + BS 4667-1974, ec Ex - Bodyguard II, AUS Coal Mines

PSS BG4 Plus				
Closed Circuit Breathing Apparatus Dräger PSS® BG 4 plus	Basic-scope of delivery without Oxygen cylinder, without CO2-scrubber and without full face mask Dräger PSS® BG 4 EP	R34601		511
Closed Circuit Breathing Apparatus positive Pressure PSS® BG 4 plus	European approval with CE-Mark G3/4" connecting thread (no longer saleable in EU) Dräger PSS® BG 4 EPL	R34611		511
PSS BG4 Plus, coal mines approved	excludes mask, cylinder, carry bag and soda lime cartridge	R34612	1	511
Dräger PSS® BG 4 AUIPK		R34703		511
PSS BG 4 - Face Masks & Accessories				
Panorama Nova RP silicone	With wiper w/o neck strap	R53316	1	422
Panorama Nova RP EPDM	With wiper w/o neck strap	R53306	1	422
FPS 7000 RP EPDM S1 Small mask	With wiper w/o neck strap & Anti scratch visor	R57675	1	422
FPS 7000 RP EPDM M2 Medium mask	With wiper w/o neck strap & Anti scratch visor	R56326	1	422
FPS 7000 RP EPDM L3 Large mask	With wiper w/o neck strap & Anti scratch visor	R57676	1	422
FPS 7000 RP Silicone M2	With wiper w/o neck strap & Anti scratch visor	R56672	1	422
FPS 7000 RP TR EPDM M2	With wiper w/o neck strap with drinking device & Anti scratch visor	R56670	1	422
FPS 7000 RP TR Silicone M2	With wiper w/o neck strap with drinking device & Anti scratch visor	R56673	1	422
Drinking reservoir	1.5L Hydro Link System	R57990	1	428
PSS BG 4 - Face Masks & Accessories				
FPS-COM 5000 without mask:	MATRIX REQUIRED	R62700	1	429
FPS-COM 5000 with RP mask	MATRIX REQUIRED	R62703	1	429

PERSONAL PROTECTIVE EQUIPMENT

PRODUCT	DESCRIPTION	PART NO	PACKAGING UNIT	CATEGORY
---------	-------------	---------	----------------	----------



Available in either a gel, liquid or spray form, Dräger's ANTI-MIST agent for mask visors.

Anti - Mist				
ANTI-MIST fluid - 50 ml bottle	For NON coated visors	R52550	1	428
ANTI-MIST gel bottle 50 ml bottle	For NON coated visors	R52560	1	428
Klar-pilot comfort ANTI MIST spray	For coated visors Marked PCas or PCaf	R56542	1	428
Filter pads	200/pkg.	R35754	1	510
DragerSorb 400	18kg	6737985	1	912
DragerSorb 400	8kg	6737965	1	912
Factory packed CO2 cartridge	Single use only	R34360	1	912
Factory packed CO2 cartridge	Single use only	R34360	52 min order qty	912
Sodalime Cartridge Fill Station		R33752	1	510
Ice mould		R33999	1	510
Cooling Cartridge for PSS BG4 Plus	Cooling insert for standard cooler box	R34746	1	510
O2 cylinder, Carbon Fibre (Includes valve) for AU only	2 litre/200Bar	B10222	1	510
Spectacle frame kit	For Panorama Nova mask only	R51548	1	428
Spectacle frame kit	For FPS 7000 mask only	R56230	1	428
Case for Protection goggles		6733935	1	499

PERSONAL PROTECTIVE EQUIPMENT

PRODUCT	DESCRIPTION	PART NO	PACKAGING UNIT	CATEGORY
---------	-------------	---------	----------------	----------



RZ 7000 test device

- Built in lithium battery 24 hr power supply
- 'CLICK" connect adaption to BG4 for extra security
- 'Built in hand pump
- Clear digital display
- Five position selector switch

Leak tests at positive & negative pressure (from -10mbar to + 10mbar) / Leak tests of exhalation valves Checking the response pressure of minimum valve and pressure reducer flow rate.

BG4 - Test Equipment				
RZ 7000		R62500	1	510
Adapter RZ 7000	Allows connection of test kit components to RZ 7000	R62599	1	591
USB cable For RZ 7000		8318469	1	510
Vehicle charging cable for RZ 7000		8320252	1	971
RZ 7000 table mounting bracket		R62561	1	546
Accessories				
Test kit for PSS BG4		R33777	1	510
Adapter for Mask	Front port, plug in Nova RP/P/PE	R53345	1	547
Adapter plug for BG4		R50028	1	547
Test Gauge for O2 cylinders	For checking BG4 cylinder pressure	R22882	1	547
Test Gauge for O2 cylinders	For BGII comparison check at service	R32272	1	591
Bodyguard II, coal mines approved	Replacement for damaged bodyguard units	R34496	1	591
Test head for testing all face masks	For connecting to RZ 7000 Complete with connection hose Base plate and bench clamp	R62581	1	547

DRUG & ALCOHOL DETECTION



Place You Put Your Faith

BREATH ALCOHOL UNITS

Alcotest 9510	197
Alcotest 3820	198
Alcotest 5000	199
Alcotest 5820	200
Alcotest 6820	200
Alcotest 7510	201
Mobile Printer for Alcotest 6820, Alcotest 7510 & DrugTest 5000	202
Interlock 7000	202
Interlock XT (Refurbished)	203
Calibration Equipment & Accessories	203

DRUG TESTING UNITS

DrugTest 5000	204
DrugCheck 3000	205

DRUG AND ALCOHOL DETECTION

PRODUCT	DESCRIPTION	PART NO	PACKAGING UNIT	CATEGORY
---------	-------------	---------	----------------	----------

ALCOTEST 9510 EVIDENTIAL BREATH ANALYSER



Ergonomically designed, the Alcotest 9510 is the latest in evidential breath alcohol analysis using a dual sensor measurement system based on infrared optical and electrochemical sensor technologies. The high resolution colour touch screen offers intuitive operation and a guided data input with complete text messages and the internal printer delivers the analysis printout. Meets the requirements of breath analysis for police and industrial purposes. NMI R 126:2000 approved. Price Includes initial verification of \$1200 (ex. gst) by VIC Police. Required for pattern approval: NMI R 126.

Alcotest 9510	Industrial version : NMI R 126 compliant	8320877	1	I
Alcotest 9510 Accessories				
Mouthpieces	With wide inlet, spit trap and non-reverse valve	6805703	25	I
	With wide inlet, spit trap and non-reverse valve	6810611	100	I
	With wide inlet, spit trap and non-reverse valve	6810610	250	I
Printer Paper Roll - thermal		8319002	5	I
Stylus		8318402	3	I
External Keyboard (mini-USB)		8319441	1	I
12 VDC Power Cable		8321310	1	I
Carry Bag		8319155	1	I
Transport Case		8318490	1	I
Cable Channel		8318489	1	I
Mounting Bracket		8318428	1	I

DRUG AND ALCOHOL DETECTION

PRODUCT	DESCRIPTION	PART NO	PACKAGING UNIT	CATEGORY
---------	-------------	---------	----------------	----------

ALCOTEST 3820 PERSONAL BREATHALYSER - NOT FOR WORKPLACE TESTING



The Dräger Alcotest® 3820 offers responsible drivers a reliable way to test their breath alcohol and gives them the assurance of being safe to drive. This is ensured by precise measurement technology identical to that used by the police: over 30 million breath alcohol tests a year.

Alcotest 3820	Includes battery, 3 mouthpieces and a microfiber bag	8327059	1	C
Mouthpieces for Alcotest 3820	(pack of 5)	8325250	1	C
Spare microfibre bag		8324994	1	C

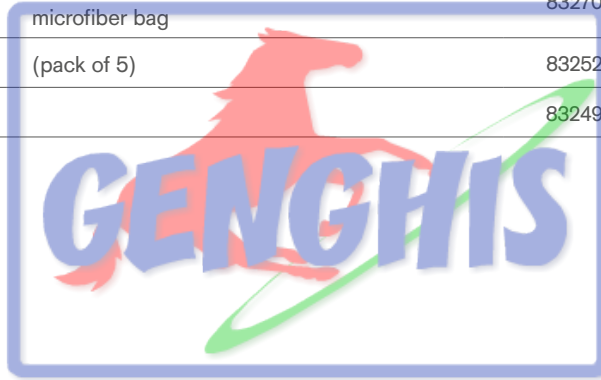

Place You Put Your Faith

DRUG AND ALCOHOL DETECTION

PRODUCT	DESCRIPTION	PART NO	PACKAGING UNIT	CATEGORY
---------	-------------	---------	----------------	----------

DRÄGER ALCOTEST 5000



The Dräger Alcotest 5000 is a Non-contact test device for e.g. police and workplace applications. It is based on the high efficient electrochemical Dräger sensor technology, which measures the presence of alcohol in the exhaled air in seconds. The test persons blow into the funnel on top of the device while keeping a short distance - so without contact to the device. The Dräger Alcotest 5000 is designed to test high number of persons in a very short time.

Dräger Alcotest 5000				
Dräger Alcotest® 5000, V1	Languages: en, de, fr, es, nl, it, ca, pt.	8327701	1	
Dräger Alcotest® 5000, V2	Languages: en, pl, fi, sv, da, no, et, lt, lv.	8327702	1	
Dräger Alcotest® 5000, V3	Languages: en, ru, uk, sk, sl, cs, hu, bs, hr.	8327703	1	
Dräger Alcotest® 5000, V4	Languages: en, el, tr, bg, ro, sr, hi, he, ar.	8327704	1	
Dräger Alcotest® 5000, V5	Languages: en, ja, ko, zh, zh-HK.	8327705	1	
Dräger Alcotest® 5000, V6	Languages: en, zhTW, ms, th, vi.	8327706	1	
Dräger Alcotest® 5000, V7	Languages: en, de, fr, es, nl, it, ca, pt.	8327707	1	

No batteries are inserted in device.

The devices have the same configuration with different language files.

Consisting of measuring device Alcotest® 5000, 3 funnels, hand loop, 3 alkaline batteries (not Dräger Alcotest® 5000, V7), microfiber bag, short Instructions for Use, no calibration certificate.

Alcotest 5000 funnel				
Alcotest 5000 Funnel, 10 pcs. Each individually packed		8327718	10	
Alcotest 5000 funnel				
Alkaline battery	Mignon, LR6, AA, 1.5V, 3 batteries needed	1335804	1	
Alcotest 5000 Accessories				
Reflex foil set yellow, Alcotest® 5000		8327742	1	
Reflex foil set orange, Alcotest® 5000		8327743	1	
Calibration Accessories				
Calibration adapter Alcotest® 5000		8327741	1	

DRUG AND ALCOHOL DETECTION

PRODUCT	DESCRIPTION	PART NO	PACKAGING UNIT	CATEGORY
---------	-------------	---------	----------------	----------

ALCOTEST 5820 - ENTRY LEVEL PROFESSIONAL BREATHALYSER



The Dräger Alcotest® 5820 allows professional users to perform a breath alcohol test with speed and accuracy. The measuring technology of this small and user-friendly portable measuring device has already proven itself over 200,000 times worldwide.

Alcotest 5820	Includes small hard case, battery, right-hand mouthpiece adapter, 3 mouthpieces and hand loop	8325200	1	C
Adapter for left handed mouthpiece adjustment		8324955	1	C
Spare Lithium Battery		4543808	1	C
Protective Cover		8324999	1	C

ALCOTEST 6820 - ADVANCED PROFESSIONAL BREATHALYSER



The same properties as the Alcotest 5510 with the following additional features. Fast, 3 second start-up of instrument and IP 54 rating. Enhanced data memory for storage and recall of the last 5000 tests. Optical interface for the transfer of test data to the Draeger Mobile Printer. PC-Communication for data download to the AlcoVIEW PC software. Optional NiMH rechargeable batteries can be used for charging inside the instrument (using optional charger). AS-3547:1997 approved.

Alcotest 6820	Includes 3 mouthpieces, 2xAA batteries, wrist strap and packaged in a hard plastic carry case.	8322660	1	C
Alcotest 6820 Accessories				
NiMH rechargeable battery - AA size	2 batteries are required for each device	1890092	1	C
Battery Charger	for charging NiMH batteries inside the device	8316991	1	C
PC Software Diagnostics Customer	Windows XP/7 software for data download (requires cable 8319715)	8317915	1	C
PC Communication cable (USB) (6820 only)	Required for Diagnostics PC software	8319715	1	C
Mouthpieces for Alcotest 5820, 6820, 3000, 5510, 6810 and 6510				
		6810690	100	C
		6810825	250	C
		6810830	1000	C
Passive Test Funnel	for Alcotest 5820, 6820, 5510, 6810 and 6510. Cannot be used with A3000 or 3820	8322621	1	C

DRUG AND ALCOHOL DETECTION

PRODUCT	DESCRIPTION	PART NO	PACKAGING UNIT	CATEGORY
---------	-------------	---------	----------------	----------

ALCOTEST 7510 - HIGH-END PROFESSIONAL BREATHALYSER



The Dräger Alcotest 7510 is a compact and robust handheld breath alcohol measuring instrument, specially designed for advanced screening applications. With the capability of detecting residual mouth alcohol, a large graphic display and flexible data management with optional GPS capabilities and enclosed in a rubber skinned housing makes this device ideal for law enforcement and workplace testing applications. Approved as an evidential breathalyser only outside of Australia.

Alcotest 7510	Includes 3 mouthpieces, 4xAA batteries, wrist strap and packaged in a hard plastic carry case.	8319760	1	C
Alcotest 7510 Accessories				
		6810690	100	C
		6810825	250	C
		6810830	1000	C
NiMH rechargeable battery - AA size	4 batteries are required for each device	1890092	1	C
Battery Charger	For charging NiMH batteries inside the device	8316991	1	C
12V Car Charger	For charging NiMH batteries inside the device	8320252	1	C
Holster Set	Protective "in-use" pouch for device	8319761	1	C
Desktop Charging Cradle	Requires battery charger (sold separately)	8319762	1	C
Infrared (IR) Module	To enable data download to PC	8319763	1	C
IR Module and Holster Set		8319764	1	C
Holster Mobile Upgrade		8319765	1	C
System Transport Case	Space for A7510, Mobile Printer, mouthpieces, batteries, paper rolls, charging cable, USB cable, keyboard.	8320251	1	C

DRUG AND ALCOHOL DETECTION

PRODUCT	DESCRIPTION	PART NO	PACKAGING UNIT	CATEGORY
---------	-------------	---------	----------------	----------

MOBILE PRINTER FOR ALCOTEST 6820, ALCOTEST 7510 AND DRUGTEST 5000



Used for printing test data from the Alcotest 6820 handheld breath alcohol instrument. Optical data transmission is used to send the test data from the instrument to the printer (no communication cable is required). The thermal printing technology is fast and quiet and requires no ribbon replacement. Powered by 4x AA Alkaline batteries or optional NiMH rechargeable batteries.

Mobile Printer		8319310	1	C
Mobile Printer Accessories				
Printer Paper Roll - thermal		8319002	5	C
NiMH rechargeable battery - AA size	4 batteries are required	1890092	1	C
Battery charger	For charging NiMH batteries inside the printer	8316991	1	C

INTERLOCK 7000 - BREATH ALCOHOL IGNITION INTERLOCK DEVICE



The Dräger Interlock 7000 is an alcohol ignition interlock device which prevents a person under the influence of alcohol from starting the vehicle. The Dräger Interlock 7000 is our premium product and used for drink driving offender programs as well as for preventative applications. The design is appealing and ergonomic and the navigation on the colour display makes the use of the device easy and intuitive. The Dräger Interlock 7000 is reliable and has an extremely quick start-up time, low power consumption, an approved temperature range of -45 °C to 85 °C, the capability of mouth alcohol detection, a data storage of 500,000 events, special encryption methods and can be equipped with a camera. The device can be fitted to all makes and models of vehicles such as cars, motorbikes, heavy vehicles, trucks, buses, forklifts and alike. Approved to all international standards such as AS-3547, EN 50436-1:2014, EN 50436-2:2014 and NHTSA.

Interlock 7000	Includes handset, control box, curly cord, cable set and 3 mouthpieces	8322570	1	I
----------------	--	---------	---	---

DRUG AND ALCOHOL DETECTION

PRODUCT	DESCRIPTION	PART NO	PACKAGING UNIT	CATEGORY
---------	-------------	---------	----------------	----------

INTERLOCK XT (REFURBISHED) - BREATH ALCOHOL IGNITION INTERLOCK DEVICE



The Dräger Interlock XT is an alcohol ignition interlock device which prevents a person under the influence of alcohol from starting the vehicle. The Dräger Interlock XT is used for drink driving offender programs as well as for preventative applications. The Dräger Interlock XT is reliable and has a quick warm-up time, an approved temperature range of -45 °C to 85 °C and a data storage of more than 30,000 events. The device can be fitted to all makes and models of vehicles such as cars, motorbikes, heavy vehicles, trucks, buses, forklifts and alike. Approved to AS-3547, EN 50436-1: 2005, EN 50436-2: 2007 and NHTSA.

Interlock 7000				
Mouthpieces	Individually packaged	8326550	5	I
	Individually packaged	8327627	50	I
	Individually packaged	8322597	300	I
Camera	For identification of driver	8322413	1	I
Handset Protector	Outer edge rubber bumper for the protection of handset	8322458	1	I
Handset Screen Protector Foil	Protects screen from scratches and fingerprints	8322457	1	I
Handset Holder (sliding)	For secure placement in the vehicle	8322610	1	I
Handset Holder (clip)	For secure placement in the vehicle	8322497	1	I
Wire Set Horn and Lights		8322417	1	I
Interlock XT Accessories				
Mouthpieces	Individually packaged	6810478	5	I
	Individually packaged	6811325	300	I
Handset Holder	For secure placement in the vehicle	8317499	1	I
Wire Set Horn and Lights		8316229	1	I

CALIBRATION EQUIPMENT & ACCESSORIES

For use with Alcotest 9510, Alcotest 7110 MKV, Alcotest 7510, Alcotest 5510/6820 & Interlock 7000/XT.

Calibration Accessories				
Pressure regulator and control valve	Used with ethanol dry gas bottles	6810693	1	C
Calibration Set (Alcotest 5510/6820 only)	Consist of 1 mouthpiece coupling, 1 calibration mouthpiece 0.5m hose.	8317927	1	C

DRUG AND ALCOHOL DETECTION

PRODUCT	DESCRIPTION	PART NO	PACKAGING UNIT	CATEGORY
---------	-------------	---------	----------------	----------

DRUGTEST 5000



The Dräger DrugTest® 5000 system is a fast and accurate means of testing oral fluid samples for drugs of abuse, such as amphetamines, meth-amphetamines, opiates, cocaine, benzodiazepines and cannabinoids, as well as precise diagnostic evaluation and data management.

DrugTest 5000 Analyser		8327900	1	I
DrugTest 5000 Accessories				
Transport Case	Hard Shell Case	8325333	1	I
Carry Bag	Soft bag	8322675	1	I
Mobile Printer	Printout of test data from the analyser	8319310	1	I
Printer Paper Roll - thermal	5 rolls	8319002	5	I
12V Car Charger		8312166	1	I
Spare Mains Charger		8315675	1	I
DrugTest 5000 Consumables				



DrugTest 5000 Test Kit (20 per box)
6 Panel: THC, MET, AMP, COC, OPI, BZO

8319965 20 I



DrugTest 5000 Test Kit (20 per box) 5 Panel:
THC, MET, AMP, COC, OPI

8321280 20 I



DCD 5000
Neat Oral-Fluid Collection Device. Second sample can be collected and sent to a laboratory for confirmatory analysis.

8319910 20 C

DRUG AND ALCOHOL DETECTION

PRODUCT	DESCRIPTION	PART NO	PACKAGING UNIT	CATEGORY
DrugTest 5000 Accessories				
	DrugTest 5000 Training Kit Dummy Test Kit for training and presentation purposes, box of 6 Includes 3x negative (yellow) and 3x positive (red) cassettes. DCD 5000	8323640	6	I
	SSK 5000 Requires DrugTest 5000 Analyser and Test Kit 8319830. The Surface Screening Kit 5000 can be used to screen for drug contamination and recognition on surfaces.	8320490	20	C
DRUGCHECK 3000	 <p>Use the Dräger DrugCheck® 3000 to find out within minutes if a person is under the influence of drugs. The compact and quick oral-fluid based system returns reliable results in a quick and easy manner. The device does not require electricity hence offers great mobility and versatility. The Dräger DrugCheck® 3000 detects the following substances:</p> <ul style="list-style-type: none"> - Cocaine (COC) - Opiates (OPI) - Cannabis (THC) - Amphetamine (AMP) - Methamphetamine (MAMP) <p><i>Place Your Faith</i></p>			
DrugCheck 3000	Box of 20 tests	8325580	20	B

MASKS & FILTERS

GUIDES

Applications	207
Selection	210
Filter types	211
Particle size	212
Filter usage & storage	213
Dräger Range	214

DISPOSABLE PARTICULATE RESPIRATORS

X-plore 1300	216
X-plore 1700	218
X-plore 1700+	220
X-plore 1900	222

REUSABLE PARTICULATE RESPIRATORS

X-plore 2100 half mask	224
X-plore 2100 accessories	225

TWIN FILTER (BAYONET) MASKS & FILTERS

Half Masks

X-plore 3000 series half masks	228
X-plore 3000 series half mask accessories	229
X-plore 3000 series half mask box kits	230

Full Masks

X-plore 5500 series full masks	232
X-plore 5500 series full masks welding accessories	233
X-plore 5500 series full mask accessories	234

Filters

Twin Filter (Bayonet) filter guide	236
Particle filters	237
Gas filters	238
Combination gas & particle filters	239

SINGLE FILTER (RD 40) MASKS & FILTERS

Half Masks

X-plore 4740	241
X-plore 4740 accessories	242

Full Masks

X-plore 6000 full face mask selection guide	246
X-plore 6000 full mask series	247
X-plore 6000 full mask series material characteristics	248

FPS 7000 full mask series	251
FPS 7000 full mask communication systems	252
X-plore 6000 & FPS 7000 accessories	253
X-plore 6000 & FPS 7000 welding accessories	254

Filters

Particle & gas filters	255
Combination gas & particle filters	256

SINGLE FILTER (RD 90) MASKS & FILTERS

Half Masks

X-plore 4790	258
X-plore 4790 accessories	259

Filters

Particle & gas filters	261
Combination gas & particle filters	261

POWERED AIR PURIFYING RESPIRATOR (PAPR)

Range overview	262
X-plore 8000 kits	264
X-plore 8700 kits	265
X-plore 8000 series components	266
X-plore 8000 carrying accessories	267
X-plore 8000 hoods & accessories	269
X-plore 8000 helmets & accessories	270
X-plore 8000 welding helmet & accessories	271
X-plore 8000 masks	272
X-plore 8000 mask accessories	274
X-plore 8000 mask welding accessories	275
X-plore 8000 filters	276

ESCAPE DEVICES

PARAT 3160 & 3260	279
PARAT 4700/5500/7500	283
PARAT training hoods and accessories	284
PARAT carrying accessories	285
PARAT 5550 fire service version	287

FIT TESTING

Qualitative fit test kit	288
--------------------------	-----

MASKS & FILTERS

The following table shows various application fields and the suitable mask-filter-combination recommended.

Here you can find a detailed list of examples of applications.

HM = half mask, VM = full face mask

Business Field	Task Application	Containment	Mask type*	Filter*	
	General				
	Handling	of chemical substances	particles and potentially identified substances	HM o. FM	ABEK Hg P3 1)
	Sampling		particles or/and potentially identified substances	HM	P3 / ABEK Hg P3 1)
	Inspection		particles and potentially identified substances	HM	ABEK P3
	Measurement		particles or/and potentially identified substances	HM	P3 / ABEK P3 1)
	Mixing	of epoxy resins and polyester resins	organic vapors	HM	A1
	Spraying/lubricating	of coolant mist	oil particles	HM / FFP2	P2
	Treatment	with preservatives	different	HM	ABEK P2
	Transport	of dangerous goods	various	FM	ABEK2 Hg P3
	Cleaning	high pressure steam blasting	soap sud mist containing adhesions	HM / FFP1	P1
	Cleaning	degreasing	grease particles	HM / FFP2	P2
	Cleaning	disinfecting	organic vapors	HM	A1 P2
	Cleaning	disinfecting with agents containing aldehydes	organic and inorganic vapors	HM	AB P2
	Cleaning	handling of petroleum ether or diluent for cellulose lacquers(solvent based)	solvent vapors	HM	A2
	Cleaning	with acids	acids	HM	ABE P2
	Construction				
	Casting, die casting	of concrete, cement (foundations)	concrete dust	HM / FFP2	P2
	Asbestos removal	asbestos	asbestos fibers	HM / FFP3	P3
	Grinding, cutting, drilling	on brickwork, concrete, stone and plaster	stone powder	HM / FFP2	P2 2)
	Grinding, cutting, drilling	of cement	dust particles	HM / FFP1	P1
	Grinding, cutting, drilling	of knifing filler of filling material	dust particles	HM / FFP1	P1 3)
	Paving	tar	organic vapors, particles	HM	A1 P2 / A2 P2 4)
	Finishing	processing of glass fiber and mineral fiber, e.g. roof insulation	dust particles and fibers	HM / FFP2	P2
	Finishing	plastering	fine plaster dust	HM / FFP2	P2
	Finishing	sealing	organic vapors	HM	A1 P2 / ABE1 P2
	Finishing	clinkering (glue)	organic vapors	HM	A1 P2 5)
	Finishing	roofing, tiling	tile and brick dust	HM / FFP2	P2
	Preparation	excavation of contaminated soil	gases, solvents, dust particles	HM	ABE1 P2
	Preparation	general demolition of brickwork, concrete, stone	dust particles	HM / FFP2	P2

MASKS & FILTERS

The following table shows various application fields and the suitable mask-filter-combination recommended.

Here you can find a detailed list of examples of applications.

HM = half mask, VM = full face mask

Business Field Task Application	Containment	Mask type*	Filter*		
	Electroplating	possibly hydrocyanic acid	HM	AB P2	
	Soldering	smoke particles	HM / FFP2	P2	
	Soldering	additionally with soldering paste	smoke particles, gases, possibly ammonia	HM	ABEK P2
	Grinding, cutting, drilling	of rust	rust powder, metallic powder	HM / FFP1/2	P1 / P2
	Grinding, cutting, drilling	of metals	metallic powder	HM / FFP2/3	P2 / P3
	Grinding, cutting, drilling	of iron	metallic powder	HM / FFP1	P1
	Grinding, cutting, drilling	of steel	metallic powder	HM / FFP1/2	P1 / P2
	Grinding, cutting, drilling	of stainless steel (high alloy)	metallic powder	HM / FFP1/3	P2 / P3
	Cutting	with laser beam	metallic powder	HM / FFP3	P3
	Welding	of aluminium	aluminium oxide smoke, ozone	HM / FFP3	P3 / A P3 4)
	Welding	of motor vehicles	metallic smoke, ozone, Nox	HM	AB P2
	Welding	manual arc welding using covered rod electrodes or laser beam welding	metallic powder, smoke	HM / FFP3	P3
	Welding / rivetting	of construction steel and zinc	metallic powder, welding smoke	HM / FFP2	P2 / ABE1 P2 4)
	Welding / rivetting	of stainless steel (Thorium electrode)	metallic powder, metallic oxide smoke	VM / FFP3	P3 / ABE1 P3 4)
	Grinding, cutting, drilling	of paint, lacquers and anticorrosion paint	fine paint particles	HM / FFP2	P2
	Grinding, cutting, drilling	of paint, lacquers and anticorrosion paint (containing chromium)	fine paint particles	VM / FFP3 2)	P3
		Grinding, cutting, drilling	of anti-fouling lacquers	fine paint particles	HM
Spraying, varnishing		with water soluble paint	fine paint mist	HM	A1 P2
Spraying, varnishing		with water soluble wood preservatives containing copper, chromium or arsenic	fine paint mist	VM / FFP3 2)	P3
Spraying, varnishing		with solvent based paint, synthetic lacquer and bleaching agents	solvent vapors and mist	HM	A2 P2 5)
Spraying, varnishing		with latex paint	paint particles	HM / FFP2	P2
Spraying, varnishin		of latex paint with the presence of residual solvents or odors	solvent vapors and paint particles	HM	A2 P2
Spraying, varnishing		of isocyanates (solvent based)	solvent vapors and paint particles	HM	A2 P2
Spraying, varnishing		with lacquers and wood preservatives	organic vapors	HM	A1 P2 / A2 P2 4)
Painting		with water soluble paint	big drops and spots of paint, vapors	HM	A1 / A1 P2
Painting		with solvent based paint, lacquers and wood preservatives	solvent vapors	HM	A1 / A1 P2 5)
Painting		with anti-fouling paint	solvent vapors	HM	A1 / A1 P3

MASKS & FILTERS

The following table shows various application fields and the suitable mask-filter-combination recommended.

Here you can find a detailed list of examples of applications.

HM = half mask, VM = full face mask

Business Field Task Application			Containment	Mask type*	Filter*
Plastic manufacturing	Grinding, cutting, drilling	of plastics	plastic powder	HM / FFP2	P2 / AB P2 7)
Waste management	Sweeping	dust	dust particles	HM / FFP3	P3
	General handling	waste sorting where odors, bacteria or spores are present	gases and dust particles	HM	A P3
	General handling	contact with mold / fungus spores	fungus spores	HM / FM / FFP2	P2 5)
Power plant	Filter exchange and revision		contaminated dust particles	HM / FFP3	P3
Farming	General handling	handling of liquid manure	gases and vapors	HM	ABEK
	Spraying	of pesticides (aqueous solutions)	insecticides / pesticides	HM / FFP2	P2
		of pesticides (organic, evaporating)	insecticides / pesticides	HM	A1 P2
	Sweeping	of barn	dust particles	HM / FFP2 Odour	P2
	Usage/cleaning	of animal feeding systems	dust particles	HM / FFP2 Odour	P2
	Cleaning/draining	of chicken / pigs farm manure pits	ammonia, H ₂ S	HM	ABE -P2 8)
Medical	General handling	contact with bacteria	bacteria	HM / FFP2	P2
Science	General handling	contact with viruses	viruses	FM / FFP3	P3
Swimming pools	Cleaning		bacteria	HM / FFP2	P2
	Cleaning	additionally water treatment with chlorine	bacteria and gases	FM	AB2 P2
Autobody	Repair	changing clutch and brake pads	fine dust, asbestos	HM / FFP3	P3
	Contact	with diesel soot / smoke	sooty particles	HM / FFP2	P2

- 1) observe exceptions
- 2) dependent on the concentration of gaseous substances
- 3) P2 if caustic
- 4) depending on the concentration
- 5) AX for low-boiling substances
- 6) FM depending on the concentration
- 7) AB, if gases might be produced
- 8) FFP2 Odour for gases below OEL

* Remarks

This table is a guide to selecting the appropriate respiratory protection products. This guide does not release the user from the obligation to comply with national application regulations and laws and is not a substitute for adhering to and understanding the product instruction manuals.

MASKS & FILTERS

MASKS & FILTERS SELECTION GUIDE

How do I choose what mask & filter is right for each application?

Please check the following before using filtering respiratory protection:

- Is there enough oxygen in the ambient air?
- What contaminants are in the ambient air?
- What are the concentrations of the contaminants?
- Are the contaminants in gas, particle, or vapour form? Or are they a mixture?
- Do the contaminants have adequate warning properties (e.g. smell or taste?)
- What are the applicable Time Weighted Averages? (TWA)
- In addition to respiratory protection, is other personal protection equipment (e.g. eye or ear protection) required?

Which respirator should I choose?

Most hazardous substances have a Safety Data Sheet (SDS) which contains a recommendation on what type of respiratory protection is required for general handling and for emergency spill response. If this isn't clear then you can use the following tools to identify the right option.



To determine what type of mask is suitable, half or full face, you can use the following calculation:

$$\frac{\text{Concentration of the hazardous substance}}{\text{Time Weighted Average (TWA)*}} =$$

The result is the minimum protection factor required. You can then reference the below table to identify the suitable mask types by choosing any option above the minimum protection factor.

Protection Factors				
Filter type	Filter class	Capacity	Half Face / Disposable	Full Face
Gas Filter	1	Small	10	50
	2	Medium	10	100
	3	Large	10	100
Particle Filter	1	Small	4	10
	2	Medium	10	50
	3	Large	10	100

Often you won't know what the expected concentration of the hazardous substance is. It is advisable to monitor the gas concentration via colourimetric gas detection tubes or digital gas detectors so you know what the potential hazard is. If in doubt, select a high level of protection.

What is the maximum concentration I can use a mask & filter up to?

You can identify what the maximum concentration the mask & filter combination can be used up to by using the following calculation:

$$\text{Protection Factor} \times \text{TWA}^* = ???$$

Protection Factors / Maximum Concentrations						
Filter type	Filter class	Capacity	Half Face	No greater than	Full Face	No greater than
Gas Filter	1	Small	10x TWA	1000 PPM	50x TWA	1000 PPM
	2	Medium	10x TWA	1000 PPM	100x TWA	5000 PPM
	3	Large	10x TWA	1000 PPM	100x TWA	10,000 PPM
Particle Filter	1	Small	4x TWA	N/A	10x TWA	N/A
	2	Medium	10x TWA	N/A	50x TWA	N/A
	3	Large	10x TWA	N/A	100x TWA	N/A

*TWA - Time Weighted Average (acceptable average exposure of a substance over an eight-hour day, for a five-day working week).

Use the following link to identify what the Australian TWA is: <http://hcis.safeworkaustralia.gov.au/ExposureStandards>

Use the following link to identify what the New Zealand TWA is: <http://www.worksafe.govt.nz/worksafe/information-guidance/all-guidance-items/workplace-exposure-standards-and-biological-exposure-indices>

Draeger Region South East Europe | Rev: 0 | Subject to modification! | www.draeger.com

Place Your Faith

PORTABLE
GAS DETECTION

PERSONAL
PROTECTION
EQUIPMENT

DRUG & ALCOHOL
DETECTION

MASKS & FILTERS

FIRE & GAS
DETECTION
SYSTEMS

ENGINEERED
SOLUTIONS

SERVICE,
TRAINING & RENTAL











DIVING
TECHNOLOGY

MASKS & FILTERS

HOW TO SELECT THE RIGHT FILTER

Contaminants come in different forms – generally: aerosols (solids/particles) and gases (gases, vapours). You can choose between the filter types to protect against one of these forms or a combination of both of them.

Solids / particles: Dusts, fibres, fumes, microorganisms (e.g. viruses, bacteria, fungi, spores) and mists

Colour code	Filter type	Contaminants present
	AX	Gases and vapours of organic compounds with boiling point ≤ 65 °C
	A	Gases and vapours of organic compounds with boiling point > 65 °C
	B	Inorganic gases and vapours, e.g. chlorine, hydrogen sulphide, hydrogen cyanide
	E	Sulphur dioxide, hydrogen chloride
	K	Ammonia and organic Ammonia derivatives
	CO	Carbon monoxide
	Hg	Mercury vapour
	NO	Nitrous Gases Including nitrogen monoxide
	Reactor	Radioactive iodine Including radioactive methyl iodide
	P	Particles

- 3) AX filters may only be used as supplied from factory. Reuse and use against gas-compounds is absolutely impermissible.
- 4) CO filters for one time use only. Must be disposed after use. Special guidelines according to local regulations apply.
- 5) Hg Filters can only be used for a maximum of 50 hours according to EN 14387.
- 6) NO filters for one time use only. Must be disposed after use.
- 7) Reactor filters: special guidelines according to local regulations apply.

Never use any kind of filtering respiratory protection device . . .

- in oxygen deficient atmospheres
- in poorly ventilated areas or confined spaces, such as tanks, small rooms, tunnels, or vessels
- where the concentrations of the toxic contaminants are unknown or are immediately dangerous to life or health
- when the concentration of a contaminant is higher than the maximum permissible concentration
- when the contaminant has poor or no warning properties (smell, taste or irritation)

MASKS & FILTERS

PARTICLE SIZE

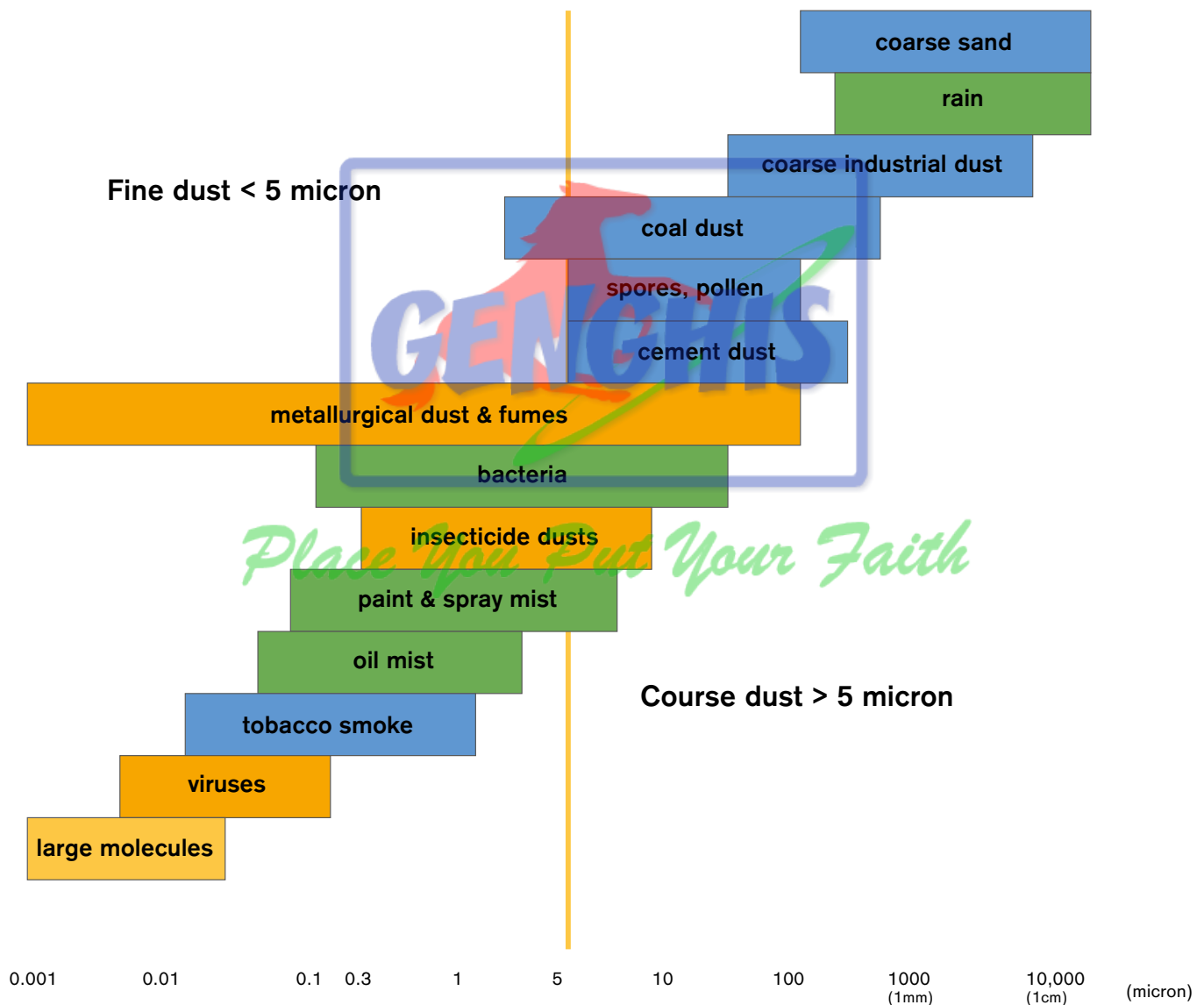

Particle filtering face masks capture particles down to 0.3 microns in diameter.

Each filter level guarantees a different minimum quantity of particles will be captured. These are:

- P1 - >80%
- P2 - >94%
- P2 - >99.95%

MASKS & FILTERS

FILTER USAGE, LIFETIMES & STORAGE

How long will the filter last for?

During Use

The service life of a respiratory filter depends on its size and on the conditions of use. Factors affecting service life:

- concentration of the contaminants
- combination of the contaminants
- air humidity
- temperature
- duration of use
- breathing rate of the user

The end of service life is generally recognisable by:

- in gas filters, by a noticeable taste or smell of the contaminant
- in particle filters, by an increased breathing resistance
- in combination filters, a noticeable taste or smell and/or an increased breathing resistance

What is the maximum life of a filter once opened?

A	6 months
B	6 months
E	6 months
K	6 months
P	6 months
AX	1 work shift
NO	1 work shift
CO	1 shift or 20 minutes of exposure
Hg	6 months or 50 hours of exposure

Regardless of their time-limited protective effect against CO and NO, multi-use filters can be used beyond these duty periods to provide protection against other substances.

AX filter usage limitations

Low-boiling group	Usage concentration	Maximum usage time (min)	Specific gases within the low-boiling groups
1	< 100 ml/m ³	40	acetaldehyde; 2-aminobutane; 2-amino-2-methyl propane; 2-bromine-2-chlorine-1,1,1-trifluoroethane; methyl bromide; 1,3-butadiene; 1-chlorine-1,1-difluoroethane; chloroform; 2-chlorine-1,3-butadiene; 3-chlorine-1-propylene; 1,1-dichlorethene; dichloromethane diethylamine; 1,1-difluoroethene; dimethyl ether; 1,1-dimethylethylamine; 1,2-epoxypropane; ethanthiol; ethylene oxide; iodmethane; methanol; monochlorodimethyl ether; 2-propenal (acrolein); propylenimine; trichloromethane; vinyl chloride
	< 500 ml/m ³	20	
2	< 1000 ml/m ³	60	acetone; bromethane; butane; chlorethane; 2-chloropropane; 1,3-cyclopentadiene; dibromodifluoromethane; 1,1-dichlorethane; 1,2-dichlorethene (cis); 1,2-dichlorethene (trans); 1,2-dichlor-1,1,2,2-tetrafluoroethane; diethyl ether; dimethoxymethane; imethylpropane; 1,3-epoxypropane; ethyl formate; glyoxal; methyl acetate; methylbutane; methyl formate; methyl propane; n-pentane; propanal
	< 5000 ml/m ³	20	

Shelf life

Filter Range	Filter Type	Lifetime (years)	Storage (years)
Rd 40 Filters	Particles	10	2
	Gas and Combination filters	4	2
Rd 90 Filters	Particles	10	2
	Gas and Combination filters	4	2
Bayonet Filters	Particles	10	1
	Gas and Combination filters	4	2

The storage time represents the time if can be in storage before being sold. Clients can expect to get at least the specified lifetime and then potentially additional time depending on how long it has been stored before supply.

Storage

Respiratory filters must be stored in rooms with normal humidity (<90 % rel. humidity), temperature (-10 °C to 55 °C) and uncontaminated air.

The maximum storage time of respiratory filters that have been first opened is 6 months if the filter is sealed again after use:

Seal RD 40 filters with the original filter plug and filter cap. Close RD 90 & Bayonet filters inside a bag or airtight container.

The shelf life can be degraded if the filters are stored under different conditions.

MASKS & FILTERS

MASK & FILTER RANGE GUIDE

What options are available in the Draeger range?

Disposable Dust/Particle Masks



X-plore 1300 - Molded masks



X-plore 1700 - foldable masks

Bayonet - Twin Filter Series

The X-plore 3000 series of half masks and X-plore 5000 series of full face masks is the most popular type within our range. A wide selection of filter options for both gas and particles is available with only the exclusion of nitrous gases & carbon monoxide.

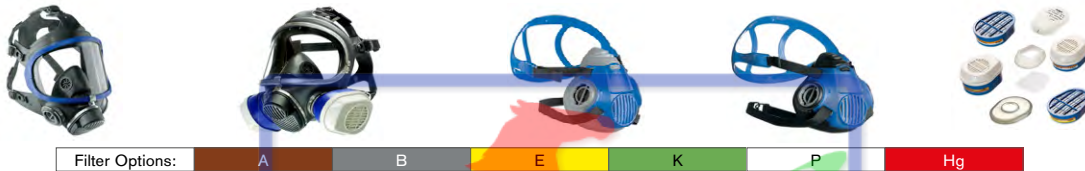

Filter Options: A B E K P Hg

RD 40 - Single Filter Series

The RD 40 series is our most comprehensive range of masks and filters. The X-plore 4740 half mask, X-plore 6000 series & FPS 7000 full face masks are within this range. RD 40 - 40mm mask thread connector



Filter Options: A B E K P Hg AX CO NO

RD 90 - Single Filter Series

The RD 90 Series is a range of filters for our X-plore 4790 half mask only. A wide selection of filter options for both gas and particles is available with only the exclusion of nitrous gases & carbon monoxide. RD 90 - 91mm mask thread connector



Filter Options: A B E K P Hg

X-plore 8000 - Powered Air Purifying Respirator

The X-plore 8000 is our gas and particle filtering belt worn powered respirator. With many different headpieces available this is our one comprehensive solution to applications requiring this type of device



Filter Options: A B E K P Hg

PARAT - Escape filter Series

The PARAT series is our escape filter range of devices. Available as a mouthpiece, half mask or hood for almost any application.



Filter Options: A B E K P

Dräger X-plore® 1300 Particle Filtering Face Piece

The Dräger X-plore® 1300 combines proven and reliable respiratory protection with intelligent new ideas ensuring a high level of comfort and ease of use.



CoolSAFE™ filter material
Performance that makes a difference: CoolSAFE™ filter material produced from high-performance filter media combines low breathing resistance and high filter performance in one mask. The material also exceeds the challenging dolomite dust test requirements.

VarioFLEX™ head harness with EasyStop
Easy to don/doff and adjust with a pressure-free fit: This continuous loop head harness is constructed from a robust, tear-proof textile strap. In contrast to other face pieces, no clips are required – preventing uncomfortable pressure and allergic reactions. The head harness can be donned/doffed easily and quickly, and without hair entanglement. Thanks to EasyStop, the head harness can easily be adjusted to fit various head sizes while sitting comfortably and safely.

Flexible nose clip
Ensures a great fit in the most critical area.

Nose seal
Safe sealing in the most critical area: all face pieces are equipped with special nose seal. It is sweat-absorbing, comfortable and most importantly ensures an effective seal around the nose.

CoolMAX™ exhalation valve (optional)
Breathe easy and comfortably with extremely low breathing resistance. The exhalation valve releases humid and warm air, preventing heat build-up underneath the mask, allowing you to stay cool while working hard.

Formed mask body
Proven, ergonomic, stable: The special design and shape of the mask body offers comfortable and secure fitting to faces with a wide variety of shapes and sizes. The masks can be donned quickly and easily. The interior volume ensures wearing comfort along with easy communication. Inside, the mask body is specially reinforced, thus ensuring dimensional stability throughout long periods of time.

Hypoallergenic inner layer
Comfortable to wear: the hypoallergenic inner layer is easy on your skin and gives the user added comfort even when used for longer periods of time.

MASKS & FILTERS

PRODUCT	DESCRIPTION	PART NO	PACKAGING UNIT/TYPE	CATEGORY
---------	-------------	---------	---------------------	----------

X-PLORE 1300 SERIES DISPOSABLE MASKS

The X-plore 1300 series of masks are our moulded/cup style, economical solution to particle protection.

Optional exhalation valve lowers breathing resistance and reduces warm & humid air to prevent uncomfortable heat build-up

Optional activated-carbon layer provides relief from nuisance level odours of organic vapors below the permissible exposure limit.

Masks packed in a plastic bag within the box.



Class P1 - Removes >80% of particles that are >0.3 microns in diameter				
1. X-plore 1310 FFP1 NR D	P1 Mask	3951211	20 / box 240 / carton 5760 / pallet	A
2. X-plore 1310 FFP1 V NR D	P1 Mask with Exhalation Valve	3951212	10 / box 180 / carton 5400 / pallet	A
Class P2 - Removes >94% of particles that are >0.3 microns in diameter				
3. X-plore 1320 FFP2 NR D	P2 Mask	3951213	20 / box 240 / carton 5760 / pallet	A
4. X-plore 1320 FFP2 V NR D	P2 Mask with Exhalation Valve	3951214	10 / box 180 / carton 5400 / pallet	A
5. X-plore 1320 FFP2 V Odour NR D	P2 Mask with Exhalation Valve & Odour Removal	3951215	10 / box 180 / carton 5400 / pallet	A

* Pricing is per mask. Minimum order of 1 box

FF - Filtering facepiece

NR - Non Reusable (1 shift maximum)

V - Exhalation Valve

D - Successfully passed the dolomite dust test against clogging to maintain low breathing resistance in high dust concentrations

Dräger X-plore® 1700 Particle Filtering Face Piece

Breathe cool, stay safe: Dräger X-plore® 1700 makes breathing easy and comfortable. The CoolSAFE™ filter material ideally combines low breathing resistance and high filter performance in one mask. And the CoolMAX™ valve efficiently releases humid and warm exhaled air to the outside. This makes breathing particularly easy and keeps you cool under the mask.

CoolSAFE™ filter material

Performance that makes a difference: CoolSAFE™ filter material produced from high-performance filter media ideally combines low breathing resistance and high filter performance in one mask. In addition, the dolomite dust testing requirements are achieved.

VarioFLEX™ head harness

This continuous loop head harness is constructed from a stable, elastic, textile strap which is easy to don and doff while ensuring a comfortable fit. The soft, tearproof elastic can easily be adjusted to fit various sizes of head and prevents hair entanglement.

Flexible nose clip

Ensures a great fit, in the most critical area.

Soft inner layer

Comfortable to wear: the inner material layer is not only soft and hypoallergenic, but also repels moisture thanks to its hydrophobic properties, keeping breathing resistance constantly low, when used for longer periods of time.

Hygienic individual packaging

Each facepiece is individually packed and sealed in a plastic bag, ensuring it stays clean and hygienic.

CoolMAX™ exhalation valve (optional)

Breathe easy and comfortably: thanks to an extremely low breathing resistance. Additionally, the specially engineered CoolMAX™ exhalation valve releases humid and warm exhaled air, preventing heat build-up underneath the mask, allowing you to stay cool.

Folded form

All Dräger X-plore® 1700s are flat-folded, saving space and making them easier to transport.

GENGHIS

Place You Put Your Faith



ST-8678-2007

MASKS & FILTERS

PRODUCT	DESCRIPTION	PART NO	PACKAGING UNIT/TYPE	CATEGORY
---------	-------------	---------	---------------------	----------

X-PLORE 1700 SERIES DISPOSABLE MASKS

The X-plore 1700 series of masks are our flat fold style, premium solution to particle protection. Optional exhalation valve lowers breathing resistance and reduces warm & humid air to prevent uncomfortable heat build-up. Optional activated-carbon layer provides relief from nuisance level odours of organic vapors below the permissible exposure limit. Masks individually packed in plastic bags within the box.



Class P1 - Removes >80% of particles that are >0.3 microns in diameter				
1. X-plore 1710 FFP1 NR D	P1 Mask	3951080	20 / box 360 / carton 8640 / pallet	A
2. X-plore 1710 FFP1 V NR D	P1 Mask with Exhalation Valve	3951081	10 / box 270 / carton 6480 / pallet	A
3. X-plore 1710 FFP1 Odour NR D	P1 Mask with Odour Removal	3951140	20 / box 360 / carton 8640 / pallet	A
4. X-plore 1710 FFP1 V Odour NR D	P1 Mask with Exhalation Valve & Odour Removal	3951082	10 / box 270 / carton 6480 / pallet	A
Class P2 - Removes >94% of particles that are >0.3 microns in diameter				
5. X-plore 1720 FFP2 NR D	P2 Mask	3951083	20 / box 360 / carton 8640 / pallet	A
6. X-plore 1720 FFP2 V NR D	P2 Mask with Exhalation Valve	3951084	10 / box 270 / carton 6480 / pallet	A
7. X-plore 1720 FFP2 V Odour NR D	P2 Mask with Exhalation Valve & Odour Removal	3951085	10 / box 270 / carton 6480 / pallet	A

* Pricing is per mask. Minimum order of 1 box

FF - Filtering facepiece

NR - Non Reusable (1 shift maximum)

V - Exhalation Valve

D - Successfully passed the dolomite dust test against clogging to maintain low breathing resistance in high dust concentrations

Dräger X-plore® 1700+ Particle Filtering Face Piece

Hardly noticeable breathing resistance thanks to the specially developed CoolSAFE+™ filter material: The Dräger X-plore® 1700+ particle filtering face pieces provide optimum breathing comfort through minimum breathing resistance.

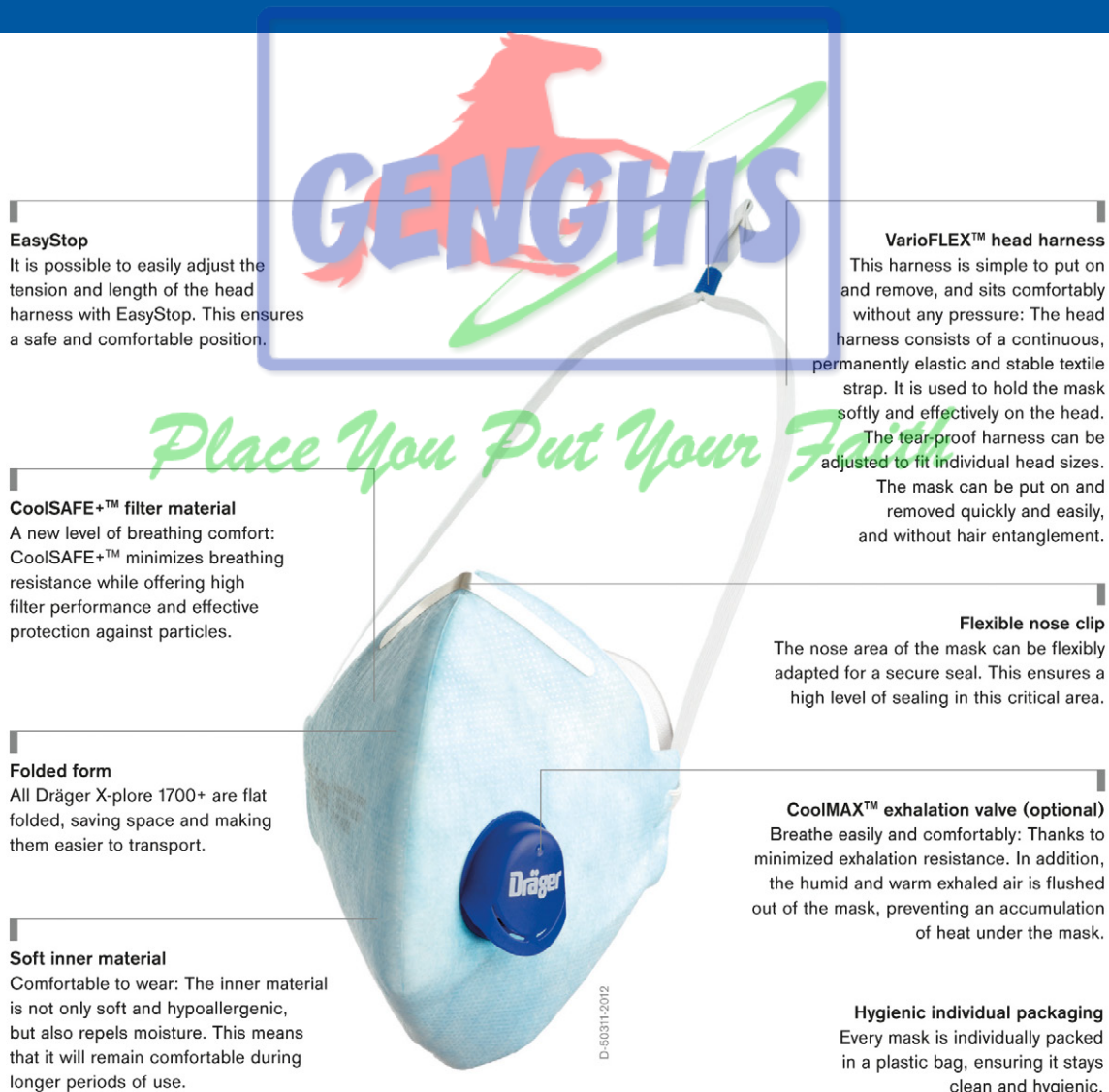

MASKS & FILTERS

PRODUCT	DESCRIPTION	PART NO	PACKAGING UNIT/TYPE	CATEGORY
---------	-------------	---------	---------------------	----------

X-PLORE 1700+ SERIES DISPOSABLE MASKS

The Dräger X-plore 1700+ flat fold mask utilises specially developed CoolSAFE™ filter material which has an increased electrostatic charge to filter particles whilst lessening the amount of filter material required which reduces the breathing resistance.

Not suitable for diesel particulate matter.

Masks individually packed in plastic bags within the box.



Class P1 - Removes >80% of particles that are >0.3 microns in diameter				
1. X-plore 1710+ FFP1 NR D	P1 Mask	3951380	20 / box 360 / carton 8640 / pallet	A
Class P2 - Removes >94% of particles that are >0.3 microns in diameter				
2. X-plore 1720+ FFP2 V NR D	P2 Mask with Exhalation Valve	3951384	10 / box 270 / carton 6480 / pallet	A

* Pricing is per mask. Minimum order of 1 box

FF - Filtering facepiece

NR - Non Reusable (1 shift maximum)

V - Exhalation Valve

D - Successfully passed the dolomite dust test against clogging to maintain low breathing resistance in high dust concentrations

Place You Put Your Faith

MASKS & FILTERS

PRODUCT	DESCRIPTION	PART NO	PACKAGING UNIT/TYPE	CATEGORY
---------	-------------	---------	---------------------	----------

Dräger X-plore® 1900 Particle Filtering Face Piece

Dräger X-plore® 1900 is a high-performance, single-use dust mask for protection against fine dust and particles. The premium particle filtering mask is available in two sizes, combining ease of use, exceptional comfort and optimal fit.

Thanks to the latest generation of CoolSAFE™ filter materials, breathing resistance is hardly noticeable. The optional models fitted with a CoolMAX™ exhalation valve keep breathing cool and easy. The flexible, continuous looped VarioFLEX™ head straps make it easy to put on. The SmartFOLD™ design with patented double reinforcement makes the mask shape highly stable and provides a generous breathing space. The mask is available in two sizes (S and M/L). This makes it suitable for many different face shapes and sizes, so each wearer can choose the right size for an optimal fit. And the three-part folding design offers high flexibility in terms of fit. The masks are also fully compatible with protective eyewear. Spectacles wearers can wear it comfortably without the mask or glasses getting in each other's way and without the spectacles fogging up. All three EN protection classes are easily recognizable through their color coding: FFP1 = yellow, FFP2 = orange, FFP3 = red.

Approval: EN 149:2001+A1:2009.

DRÄGER X-PLORE® 1900

Place You Put Your Faith

Dräger X-plore® 1910 FFP1

Protection against solid and liquid particles.
Available in two sizes.



1.. Dräger X-plore® 1910	FFP1 NR D, size M/L	3951910	1	A
1. Dräger X-plore® 1910	FFP1 NR D, size S	3951911	1	A
2. Dräger X-plore® 1910 V	FFP1 NR D, size M/L with CoolMAX™ exhalation valve	3951915	1	A
2. Dräger X-plore® 1910 V	V FFP1 NR D, size S with CoolMAX™ exhalation valve	3951916	1	A

MASKS & FILTERS

PRODUCT	DESCRIPTION	PART NO	PACKAGING UNIT/TYPE	CATEGORY
---------	-------------	---------	---------------------	----------

Dräger X-plore® 1920 FFP2

Protection against solid and liquid particles.
Available in two sizes.



1. Dräger X-plore® 1920	FFP1 NR D, size M/L	3951920	1	A
1. Dräger X-plore® 1920	FFP1 NR D, size S	3951921	1	A
2. Dräger X-plore® 1920 V	FFP1 NR D, size M/L with CoolMAX™ exhalation valve	3951925	1	A
2. Dräger X-plore® 1920 V	V FFP1 NR D, size S with CoolMAX™ exhalation valve	3951926	1	A

Dräger X-plore® 1930 FFP3

Protection against solid and liquid particles.
Available in two sizes.

Place You Put Your Faith



1. Dräger X-plore® 1930	FFP1 NR D, size M/L	3951930	1	A
1. Dräger X-plore® 1930	FFP1 NR D, size S	3951931	1	A
2. Dräger X-plore® 1930 V	FFP1 NR D, size M/L with CoolMAX™ exhalation valve	3951935	1	A
2. Dräger X-plore® 1930 V	V FFP1 NR D, size S with CoolMAX™ exhalation valve	3951936	1	A

Dräger X-plore® 2100 Half Mask

The Dräger X-plore® 2100 is the reusable alternative to disposable dust masks. The X-plore® 2100 is the ideal solution for people working frequently in dusty environments. Its replaceable filters provide protection against solid and liquid particles. This half mask offers the perfect combination of comfort, safety and cost-effectiveness.

Head harness with anti-slip head strap

- One-piece with two adjustment points
- Quick and easy donning and doffing
- Excellent pressure distribution

Comfortable mask body

- High quality tight fit
- Choose between two high quality materials: EPDM and silicone
- Two sizes for silicone masks: for the best wearer comfort and tight fit

Dräger replacement filter

- Protection levels FMP2 and FMP3
- High filter efficiency and low breathing resistance
- Quick and easy replacement of the replaceable filter
- Very efficient in use

Flexible textile strap

- Tighten the mask with one pull

„Drop-down“ strap system with neck clips

- Protection during breaks from work as well: The mask can be removed simply by opening the neck clips without removing the helmet
- Protected against contamination in standby position: the mask remains with its inside against the body

Smooth-running exhalation valve

- Comfortable microclimate in the mask: exhalation valve removes exhaled air to the outside from below



MASKS & FILTERS

PRODUCT	DESCRIPTION	PART NO	PACKAGING UNIT/TYPE	CATEGORY
---------	-------------	---------	---------------------	----------

X-PLORE 2100 SERIES REUSABLE PARTICLE HALF MASK

X-plore 2100 Half Mask

The X-plore 2100 is a reusable half mask that filters particles only. The filter can be reused for multiple workshifts making it a very cost efficient alternative to disposable particle masks. The soft & flexible body improves the facial fit in comparison to a disposable mask.



1. X-plore 2100, universal size	EPDM, suits particle filter 6737352	R55881	1 / box	A
2. X-plore 2100, size S/M	Silicone, suits particle filter 6737352	R55883	1 / box	A
2. X-plore 2100, size M/L	Silicone, suits particle filter 6737352	R55882	1 / box	A

X-plore 2100 Filter

3. P2 Filter R D	Replacement particle filter P2	6737352	20 / box	A
------------------	--------------------------------	---------	----------	---

X-plore 2100 Mask & Filter Kits - Mask plus 5 Filters



4. X-plore 2100 M/L Mask + 5 Filters	EPDM, particle filter P2/P3* R D	R55910	1 / box	A
5. X-plore 2100 M/L Mask + 5 Filters	Silicone, particle filter P2/P3* R D	R55915	1 / box	A

* The filter is P3 but due to restrictions in the Australian Standard regarding half masks, it can only be classified a P2

Spare Parts

Headharness	Blue plastic part only	R54225	1 / box	H
Headstrap	Elastic strap & hook only	R55218	1 / box	H
Filter cover		R53140	1 / box	H
Inhalation valve disc	Replacement inhalation valve	R52510	10 / box	H
Exhalation valve disc	Replacement exhalation valve	R52541	5 / box	H

MASKS & FILTERS

PRODUCT	DESCRIPTION	PART NO	PACKAGING UNIT/TYPE	CATEGORY
---------	-------------	---------	---------------------	----------

X-PLORE 2100 SERIES REUSABLE PARTICLE HALF MASK

Accessories



6. Wikru Storage and Transport Box	Suits half face masks, not with filter attached	RM07000	1 / box	D
7. Mask Disinfectant Wipes	For quick cleaning of masks (10pcs)	R54134	1 / box	D

* Pricing is per filter/part. Minimum order of 1 box

EPDM - Ethylene propylene diene terpolymer

Si - Silicone

R - Reusable (not limited to 1 shift)

D - Successfully passed the dolomite dust test against clogging to maintain low breathing resistance in high dust concentrations

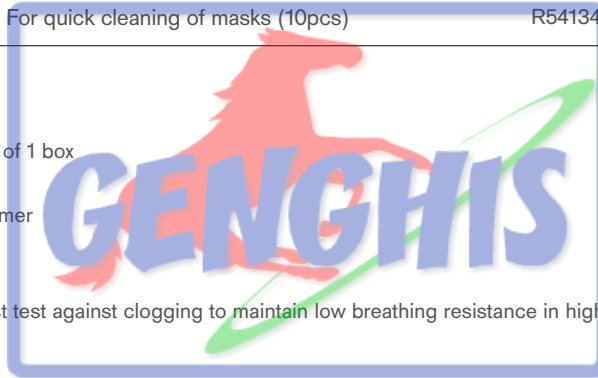

Material Characteristics	EPDM	Silicone
Elasticity	2	1
Tear Strength Values	2	2
Abrasion	2	2
Tensile Strength	2	3
Heat	3	1
Flame	2	3
Flexibility when cold	2	1
Solvents	2	1
Aggressive Chemicals (eg. phosgene, H2S)	1	5

1 = very good, 2 = good, 3 = acceptable, 4 = sufficient, 5 = insufficient

Dräger X-plore® 3300 Half Mask

Practical use and comfort: Dräger X-plore® 3300 offers both and additionally excels by its economical and low maintenance use.



Dräger "FlexiFit" head harness

- Innovative, pliable material
- Ergonomic design
- Easy donning and doffing
- Excellent fit, remains in position on every head without trapping any hair
- Good pressure distribution: the head harness does not exert pressure, even under the helmet

Compact "low profile" design

- Side positioning of the filters and flat construction
- Excellent field of vision
- Good fit for use under protective
- Three sizes (S, M, L) are available to fit every face

Innovative X guide of the harness

- Very easy to adjust
- Optimal weight and stress distribution
- Excellent wearer comfort



ST-5458-2007

Flexible nasal area

- Special design for extra tight fit and good shape— even with safety goggles

Safer bayonet-type connectorn

- Inserting the filters is easy: both filters are inserted from above and guided down to the connection point
 - Cannot be fitted incorrectly

Dräger X-plore® 3500 Half Mask

A perfect combination of durability, protection and comfort. For harsh conditions and long duration use, the Dräger X-plore® 3500 half mask is the first choice.

Dräger „FlexiFit“ head harness

- Innovative, pliable material
- Ergonomic design
- Easy donning and doffing
- Excellent fit, remains in position on every head without trapping any hair
- Good pressure distribution: the head harness does not exert pressure, even under the helmet

Flexible nasal area

- Special design for extra tight fit and good shape – even with safety goggles

Compact „low profile“ design

- Side positioning of the filters and flat construction
- Excellent field of vision
- Good fit for use under protective
- Three sizes (S, M, L) are available to fit every face

Innovative X guide of the harness

- Very easy to adjust
- Optimal weight and stress distribution
- Excellent wearer comfort



ST-719.2006

Place You Fit Your Faith



„Drop-down“ strap system with neck clips

- Protection during breaks from work as well: The mask can be removed simply by opening the neck clips without removing the helmet
- Protected against contamination in standby position: the mask remains with its inside against the body

Safer bayonet-type connectorn

- Inserting the filters is easy: both filters are inserted from above and guided down to the connection point
- Cannot be fitted incorrectly

MASKS & FILTERS

PRODUCT	DESCRIPTION	PART NO	PACKAGING UNIT/TYPE	CATEGORY
---------	-------------	---------	---------------------	----------

X-PLORE 3000 SERIES TWIN FILTER MASKS

X-plore 3300 and 3500 Series Bayonet Filter Half Masks

The X-plore 3000 series of masks should be your first choice of half mask within the Draeger range. The bayonet twin filter design provides the highest level of wearer comfort due to the optimal weight distribution and swept back filters. Masks come with a sealable plastic bag for storage.



1. X-plore 3300, size S		R55331	1 / box	A
1. X-plore 3300, size M	Economical bayonet filter half mask with a specially designed flexible nose area for a secure fit and the 'FlexFit' high comfort head harness	R55330	1 / box	A
1. X-plore 3300, size L		R55332	1 / box	A
2. X-plore 3350, size S		AH10264	1 / box	A
2. X-plore 3350, size M	The X-plore 3300 redesigned to fit the Asian face shape. Comes with an economical head harness	AH10263	1 / box	A
2. X-plore 3350, size L		AH10265	1 / box	A
3. X-plore 3500, size S	Premium bayonet filter mask with the features of the 3300 + 'drop-down' neck strap and	R55351	1 / box	A
3. X-plore 3500, size M	'DrägerFlex' mask body material which provides excellent chemical resistance and protection with hypoallergenic properties	R55350	1 / box	A
3. X-plore 3500, size L		R55352	1 / box	A
4. X-plore 3550, size S		AH10261	1 / box	A
4. X-plore 3550, size M	The X-plore 3500 redesigned to fit the Asian face shape	AH10260	1 / box	A
4. X-plore 3550, size L		AH10262	1 / box	A

Spare Parts

Headstrap	Replacement Headstrap	R55224	1 / box	H
Yoke	Blue plastic front exhalation cover	R55228	1 / box	H
Inhalation valve disc	Replacement inhalation valve	R53309	10 / box	H
Exhalation valve disc	Replacement exhalation valve	R52541	5 / box	H

MASKS & FILTERS

PRODUCT	DESCRIPTION	PART NO	PACKAGING UNIT/TYPE	CATEGORY
---------	-------------	---------	---------------------	----------

X-PLORE 3000 SERIES TWIN FILTER MASKS

Accessories





1. Wikru Storage and Transport Box	Suits half face masks, not with filter attached	RM07000	1 / box	D
2. Mask Disinfectant Wipes	For quick cleaning of masks (10pcs)	R54134	1 / box	D



Place You Put Your Faith

MASKS & FILTERS

PRODUCT	DESCRIPTION	PART NO	PACKAGING UNIT/TYPE	CATEGORY
X-plore 3300 and 3500 Series Bayonet Filter Half Masks with Filters in a Retail Box				
1				
1 Construction Set	X-plore 3500 (M) with 1 pair of P2/P3 particle filter (6738353)	R56960	1 / box	A
2 Painter/Agriculture Set	X-plore 3300 (M) with 1 pair of A2-P2/P3 filter (6738875)	R57793	1 / box	A
3 Chemical Works Set	X-plore 3300 (M) with 1 pair of A1B1E1K1Hg-P2/P3 filter (6738817)	R57794	1 / box	A

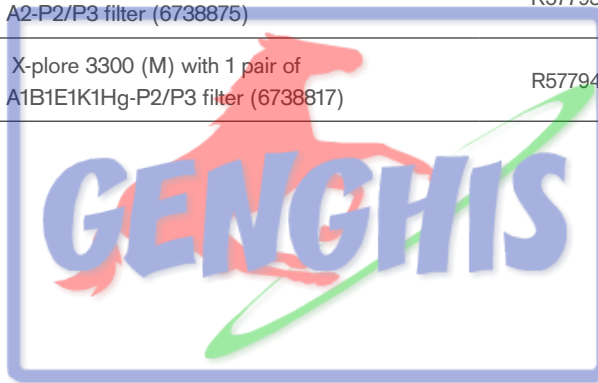

Place You Put Your Faith

Dräger X-plore® 5500 Full Face Mask

Whether in the chemical, metal, or automotive industries, ship building, supplies, or disposal: The Dräger X-plore® 5500 full face mask is the right solution for environments where not only increased respiratory protection is required, but also a clear vision is mandatory.

Comfortable and secure fit

- Double sealing frame with threefold sealing edges
- More secure protection and tight fit

5-point harness

- Simple donning and doffing without trapping any hair

Large visor (180° angle)

- Optimal view during work
- Made from Polycarbonate or Triplex

Safe bayonet-type connector

- Simple insertion of the filters:
Both filters are inserted from above and guided down to the connection point
- Cannot be fitted incorrectly

Compact „low profile“ design

- Side positioning of the filters and flat construction
- Unrestricted field of vision



MASKS & FILTERS

PRODUCT	DESCRIPTION	PART NO	PACKAGING UNIT/TYPE	CATEGORY
---------	-------------	---------	---------------------	----------

X-PLORE 5000 SERIES TWIN FILTER MASKS

X-plore 5500 Full Face Masks

The X-plore 5000 series of masks should be your first choice of full face mask within the Draeger range. The bayonet twin filter design provides the highest level of wearer comfort due to the optimal weight distribution and swept back filters.



1. X-plore 5500 PC	EPDM body, blue plastic frame, polycarbonate visor, 5-point harness	R55270	1 / box	A
2. X-plore 5500 Triplex	EPDM body, triplex glass visor, stainless steel frame	R56655	1 / box	A
Spare Parts				
3. Headstrap	Replacement Headstrap (no buckles)	R26279	1 / box	H
4. Polycarbonate (PC) Visor	Replacement PC Visor	R50833	1 / box	H
4. Triplex Glass Visor	Replacement Triplex Glass Visor	R26989	1 / box	H

PC - Polycarbonate

Triplex - Triplex Laminated Glass

EPDM - Ethylene propylene diene terpolymer

Place You Put Your Faith

Resistance against:	Polycarbonate Visor	Triplex Glass Visor
Heat	up to 125 °C	up to 200°C
Abrasion	3	1
Shock, impact	1	3
Flection	1	4
Chemicals	3	1
Identification mark at the top of the visor	PC	L

1 = very good, 2 = good, 3 = acceptable, 4 = sufficient, 5 = insufficient

MASKS & FILTERS

PRODUCT	DESCRIPTION	PART NO	PACKAGING UNIT/TYPE	CATEGORY
---------	-------------	---------	---------------------	----------

X-PLORE 5000 SERIES TWIN FILTER MASKS

Welding



1. Welding Attachment	For the X-plore 5500 with triplex glass visor only. Welding adaptor required.	4053437	1 / box	D
2. Welding Adaptor	Frame for the welding attachment to fit the protective welding filter/lens below	R57308	1 / box	D
3. Welding filter no 9		R55349	10 / box	A
3. Welding filter no 10		R55052	10 / box	A
3. Welding filter no 11		R55078	10 / box	A
3. Welding filter no 12		R55468	10 / box	A
3. Welding filter no 13		R55429	10 / box	A
4. Welding filter, auto-darkening	Default shade level of 3 and then changes to 11 when welding	R55353	1 / box	A
5. Welding filter, auto-darkening	Default shade level of 4 and then changes to 9-13 when welding	R57635	1 / box	A
Protective plate Outside	Polycarbonate welding filter protector	R55118	10 / box	A

MASKS & FILTERS

PRODUCT	DESCRIPTION	PART NO	PACKAGING UNIT/TYPE	CATEGORY
---------	-------------	---------	---------------------	----------

X-PLORE 5500 SERIES TWIN FILTER MASKS

Accessories

				
1. Mask Disinfectant Wipes	For quick cleaning of masks (10pcs)	R54134	1 / box	D
3. Wikov V Transport Case	For the X-plore 5500 without filters attached	R51019	1 / box	D
5. Visor covers / Lens protectors	Self-adhesive lens covers (25pcs). 1 cover attaches at a time via 2 adhesive strips	4055092	1 / box	D
6. Spectacle Frame	Insert for the X-plore Full Face Masks. Lenses to be fitted by a local optometrist	R51548	1 / box	D
8. Klar-Pilot gel (50 ml)	Klar-Pilot prevents visors and mask spectacles from fogging even in case of extreme temperature differences.	R52560	1 / box	D

Place You Put Your Faith

Dräger X-plore® Bayonet Filter

Experience a new dimension of comfort and safety in respiratory protection: the Dräger X-plore® Twinfilter series. Utilization of modern materials coupled with an attractive design ensures maximum comfort and user acceptance.



ST-17458-2008

MASKS & FILTERS

CARTRIDGE SELECTION AND REPLACEMENT PARTS

GAS & VAPOUR CARTRIDGES

A1/A2
Protection: organic gases and vapours (boiling point >65°C)
67 38 872 / 67 38 873



A1B1E1
Protection: organic gases and vapours (boiling point >65°C), inorganic gases and vapours (e.g. chlorine, hydrogen sulphide, hydrogen cyanide), sulphur dioxide and hydrogen chloride
67 38 778



A1B1E1K1
Protection: organic gases and vapours (boiling point >65°C), inorganic gases and vapours (e.g. chlorine, hydrogen sulphide, hydrogen cyanide), sulphur dioxide and hydrogen chloride, ammonia and organic ammonia derivate
67 38 816



A2B2
Protection: organic gases and vapours (boiling point >65°C), inorganic gases and vapours (e.g. chlorine, hydrogen sulphide, hydrogen cyanide)
67 38 775



PARTICULATE FILTERS

Pad P1 NR
Protection: Oil and solid particulates
67 38 020



Pad P2 R
Protection: Oil and solid particulates
67 38 002



Pure P2 R/Pure P3 R
Protection: Oil and solid particulates
67 38 353 / 67 38 354



Pure Odour P3 R
Protection: Oil and solid particulates, nuisance odours
67 38 391



P3 R
Protection: Oil and solid particulates
67 38 011



Pad Retainer
67 38 038



Filter Pad Base
67 38 039



Dräger X-plore® Pure Adapter
67 38 356



TWIN FILTER MASKS

Dräger X-plore® 3300
Economical Half Mask
Size S **R 55 331**
Size M **R 55 330**
Size L **R 55 332**



Dräger X-plore® 3500
Premium Half Mask
Size S **R 55 351**
Size M **R 55 350**
Size L **R 55 352**



Dräger X-plore® 5500 PC
Full Face Mask, universal size
R 55 270



Dräger X-plore® 5500 Triplex
Full Face Mask, universal size
R 56 655



Pre-Filter Retainer
67 37 576



Course Particulate Pre-Filter
67 38 159



COMBINATION CARTRIDGES

A1 P3 R D
Protection: organic gases and vapours (boiling point >65°C) and particles
67 38 874



A2 P3 R D
Protection: organic gases and vapours (boiling point >65°C) and particles
67 38 875



A1B1E1K1 Hg P3 R D
Protection: organic gases and vapours (boiling point >65°C), inorganic gases and vapours (e.g. chlorine, hydrogen sulphide, hydrogen cyanide), sulphur dioxide and hydrogen chloride, ammonia and organic ammonia derivatives, mercury vapour and particles
67 38 817



A2B2 P3 R D
Protection: organic gases and vapours (boiling point >65°C), inorganic gases and vapours (e.g. chlorine, hydrogen sulphide, hydrogen cyanide) and particles
67 38 776



A2B2E2K2 Hg P3 R D*
Protection: organic gases and vapours (boiling point >65°C), inorganic gases and vapours (e.g. chlorine, hydrogen sulphide, hydrogen cyanide), sulphur dioxide and hydrogen chloride, ammonia and organic ammonia derivatives, mercury vapour and particles
67 38 819

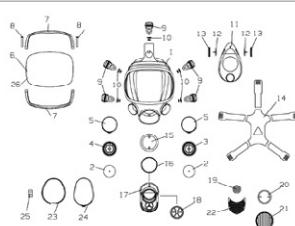

Position	Designation	Order No.	Pack. Unit
1-25	Dräger X-plore® 5500 PC	R 55 270	1 13
1-5, 7-26	Dräger X-plore® 5500 Triplex	R 56 655	1 14
1	Mask body EPDM (Ciz)	R 55 266	1 15
2	Valve disc	R 51 486	10 16
3	Filter connector left	R 55 263	1 17
4	Filter connector right	R 55 262	1 18
5	Clamp	R 54 748	1 19
6	Visor PC	R 50 833	1 20
7	Clamping frame, plastic blue	R 55 273	1 21
8	Screw DWN 562 3x20 (Torx)	13 90 006	10 22
9	Sliding buckle	R 28 329	10 23
10	Double button	RM 08 910	15 24
11	Inner mask EPDM	R 52 822	1 25
12	Control valve plate	RM 08 304	10 26

Valve seat	RM 08 303	10
Head strap EPDM	R 26 279	1
Screw ring	R 54 442	4
O-Ring	T 10 549	10
Connecting piece	R 52 995	1
Valve seat	R 53 870	10
Exhalation valve disc	R 52 541	5
Plug	R 55 267	10
Cap	R 55 268	1
Cap black	R 52 552	5
Slide ring	R 52 194	10
Clamp	R 52 185	10
Support plate	R 53 179	10
Triplex glass visor	R 26 989	1

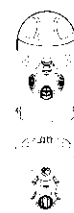

Position	Designation	Order No.	Pack. Unit
1-6	Half Mask Dräger X-plore 3500 medium, reusable	R 55 350	1
1-5, 7	Half Mask Dräger X-plore 3500 small, reusable	R 55 351	1
1-5, 8	Half Mask Dräger X-plore 3500 large, reusable	R 55 352	1
1	Yoke	R 55 228	1
2	Exhalation valve disk	R 52 541	5
3	Inhalation valve disk	R 53 309	10
4	Head strap, complete	R 55 224	1
5	Fabric ribbon with hook	R 55 218	1
6	Mask body M, Dräger X-plore 3500	R 55 226	1
7	Mask body S, Dräger X-plore 3500	R 55 225	1
8	Mask body L, Dräger X-plore 3500	R 55 227	1

*only for use with full face masks

MASKS & FILTERS

PRODUCT	DESCRIPTION	PART NO	PACKAGING UNIT/TYPE	CATEGORY
---------	-------------	---------	---------------------	----------

BAYONET PARTICLE FILTERS

Bayonet P1 & P2 Pad Particle Filters

Lowest cost bayonet filter option for P1 or P2 protection. The pad base and retainer are kept whilst only the filter is discarded and replaced



1 Bayonet Pad P1 NR	Cannot be connected to a mask without the pad base & retainer	6738001	20 / pcs (10 / pairs)	A
1 Bayonet Pad P2 R	Cannot be connected to a mask without the pad base & retainer	6738002	20 / pcs (10 / pairs)	A
2 Bayonet Pad Base for P1 & P2 Pads	Reusable	6738039	12 / pcs (6 / pairs)	A
3 Bayonet Pad Retainer for P1 & P2 Pads	Reusable	6738038	12 / pcs (6 / pairs)	A

Bayonet Pure Series P2 & P3 Particle Filters

The Pure series and plastic housed filter have the bayonet connection built into them so they can be connected directly to the mask without the need for the pad base and retainer. The Plastic housed P3 filter is perfect for asbestos applications as the filter can be safely handled after use.



1 Bayonet Pure P2 Filter R	For direct connection to the X-plore Bayonet masks	6738353	20 / pcs (10 / pairs)	A
1 Bayonet Pure P3 Filter R	For direct connection to the X-plore Bayonet masks. Only P3 when used with a full face mask	6738354	20 / pcs (10 / pairs)	A
2 Bayonet Pure Odour P3 Filter R	Same as above with nuisance odour removal	6738391	20 / pcs (10 / pairs)	A
3 Bayonet P3 Plastic Housed Filter R	For direct connection to the X-plore Bayonet masks. Only P3 when used with a full face mask	6738011	22 / pcs (11 / pairs)	A
4. Pure Adaptor	Reusable adaptor to attach Pure filter to gas filter	6738356	10 / pcs (5 / pairs)	A

Pricing is per filter/pad/retainer/adaptor. Minimum order of 1 box

NR - Non Reusable (1 shift maximum)

R - Reusable (not limited to 1 shift)

Did you know that Draeger has an online database where you can check what the correct filter is for each hazardous substance?

<http://www.draeger.net/voice/default.do?country=MH&language=en>

MASKS & FILTERS

PRODUCT	DESCRIPTION	PART NO	PACKAGING UNIT/TYPE	CATEGORY
---------	-------------	---------	---------------------	----------

BAYONET GAS & PARTICLE FILTERS

Bayonet Gas Filter

The Bayonet range of filters are for the X-plore 3000 & 5000 series of masks. The filters come vacuum sealed as pairs within a retail box.



1. Bayonet A1 Filter	A	6738872	20 / pcs (10 / pairs)	A
1. Bayonet A2 Filter	A	6738873	20 / pcs (10 / pairs)	A
1. Bayonet A2B2 Filter	A B	6738775	18 / pcs (9 / pairs)	A
1. Bayonet A1B1E1 Filter	A B E	6738778	20 / pcs (10 / pairs)	A
1. Bayonet A1B1E1K1 Filter	A B E K	6738816	20 / pcs (10 / pairs)	A
2. Bayonet Pad P1 NR	Can be added to the above gas filters with the pad retainer	6738001	20 / pcs (10 / pairs)	A
2. Bayonet Pad P2 R		6738002	20 / pcs (10 / pairs)	A
3. Bayonet Pad Retainer for P1 & P2 Pads	Reusable	6738038	12 / pcs (6 / pairs)	A

Pricing is per filter/pad/retainer/adaptor. Minimum order of 1 box

NR - Non Reusable (1 shift maximum)

R - Reusable (not limited to 1 shift)

Did you know that Draeger has an online database where you can check what the correct filter is for each hazardous substance?

<http://www.draeger.net/voice/default.do?country=MH&language=en>

MASKS & FILTERS

PRODUCT	DESCRIPTION	PART NO	PACKAGING UNIT/TYPE	CATEGORY
---------	-------------	---------	---------------------	----------

BAYONET COMBINATION AND PREFILTERS

Bayonet Combination Gas & Particle Filter

The Bayonet range of filters are for the X-plore 3000 & 5000 series of masks. The filters come vacuum sealed as pairs within a retail box.



1. Bayonet A1 P3 R D	A	P	6738874	14 / pcs (7 / pairs)	A				
1. Bayonet A2 P3 R D	A	P	6738875	14 / pcs (7 / pairs)	A				
1. Bayonet A2B2 P3 R D	A	B	P	6738776	12 / pcs (6 / pairs)	A			
1. Bayonet A1B1E1K1 Hg P3 R D	A	B	E	K	Hg	P	6738817	14 / pcs (7 / pairs)	A
1. Bayonet A2B2E2K2 Hg P3 R D	A	B	E	K	Hg	P	6738819	10 / pcs (5 / pairs)	A
2. Particle Prefilter for Combination Filter	To protect combination filters against clogging and extend their usable life		6738159	40 / pcs (20 / pairs)	A				
3. Prefilter Retainer	To attach particle prefilters to combination filters		6737576	14 / pcs (7 / pairs)	A				

* Pricing is per filter. Minimum order of 1 box

R - Reusable (not limited to 1 shift)

D - Successfully passed the dolomite dust test against clogging to maintain low breathing resistance in high dust concentrations

Did you know that Draeger has an online database where you can check what the correct filter is for each hazardous substance?

<http://www.draeger.net/voice/default.do?country=MH&language=en>

Dräger X-plore® 4700 Half Mask

The Dräger X-plore® 4700 is the robust half mask which offers excellent comfort and outstanding leak tightness for demanding applications. Thanks to the wide range of filters available for protection against gases, vapours and particles, it is ideally suited for use in a variety of industries.



MASKS & FILTERS

PRODUCT	DESCRIPTION	PART NO	PACKAGING UNIT/TYPE	CATEGORY
---------	-------------	---------	---------------------	----------

X-PLORE 4700 SERIES SINGLE FILTER MASKS

X-plore 4740 RD 40 Half Mask Series

The X-plore 4700 is best suited for applications where there is no bayonet filter option or where there is irregular use and the preference is to only buy 1 filter which is possible in the RD40 filter range. Clients who already have our X-plore 6000 range or FPS 7000 with the RD 40 connection can also benefit from having a half mask that accepts the same range of filters.



1. X-plore 4740 TPE M/L	TPE	R55876	1 / box	A
2. X-plore 4740 Si S/M	Silicone	R55875	1 / box	A
2. X-plore 4740 Si M/L	Silicone	R55874	1 / box	A
3. X-plore 4740Si EH M/L	Silicone. Elastic head harness without neck hooks	R56710	1 / box	A

Si (Silicone) - Mask body material which is very gentle on skin, provides a good facial seal and a higher level of wearing comfort
 TPE (thermoplastic elastomer) - Mask body material which fits well and is chemically resistant

TPE or Silicone, which one should I pick?

There are some advantages and disadvantages to both; it just depends on the application/situation. Silicone is usually not allowed in paint areas as silicone material can affect the finish of paint (causing "fish-eye"), and aggressive chemicals (e.g. hydrogen sulphide) can permeate through silicone. Because silicone is porous, you must thoroughly rinse it after disinfecting (think longer maintenance). Also, silicone is very slippery when it gets wet from sweat, thus causing it to slide around, which in turn can cause leaks. On the flip-side, silicone is very comfortable, cleans up easily due to smooth surface and holds up very well in extreme cold temperatures. TPE fits well in situations where silicone has disadvantages.

Material Characteristics	Silicone	TPE
Elasticity	1	2
Tear Strength Values	2	3
Abrasion	2	2
Tensile Strength	3	4
Heat	1	5
Flame Resistance	3	4
Flexibility when cold	1	3
Solvents	1	4
Aggressive Chemicals (eg. phosgene, H2S)	5	-

1 = very good, 2 = good, 3 = acceptable, 4 = sufficient, 5 = insufficient



MASKS & FILTERS

PRODUCT	DESCRIPTION	PART NO	PACKAGING UNIT/TYPE	CATEGORY
---------	-------------	---------	---------------------	----------

X-PLORE 4700 SERIES SINGLE FILTER MASKS

Spare Parts				
Headharness	Complete headharness & straps	R55224	1 / box	H
Elastic Headstrap	Complete headstrap	R56723	1 / box	H
Yoke	Blue plastic front cover	R53294	1 / box	H
Inhalation valve disc	Replacement inhalation valve	R53309	10 / box	H
Exhalation valve disc	Replacement exhalation valve	RM05064	10 / box	H

Accessories

				
1. Daisy Quick Disinfectant Wipes	For quick cleaning of masks (10pcs)	R54134	1 / box	D
3. Wikru Storage and Transport Box	Suits half face masks, also with filter attached	RM07000	1 / box	D
4. Remote Breathing Hose	To wear RD 40 filter on the belt	R53850	1 / box	A

Place You Put Your Faith

Dräger X-plore® 6300 Full Face Mask

The Dräger X-plore® 6300 is the efficient yet low-cost full face breathing mask intended for price-conscious users not wishing to compromise on comfort or quality. This full face mask is the successor to the Panorama Nova Standard, a mask which has proven itself over decades of use worldwide – redesigned and improved with fresh colours and an integrated bar code.



Dräger X-plore® 6530 Full-Face Mask

The Dräger X-plore® 6530 is the most widely used full face mask from professionals in a wide variety of applications. It meets the highest demands for quality, reliability, secure fit and comfort. This full face mask is the successor to the Panorama Nova masks, a range which has proven itself over decades of use worldwide.



SI-7499-2005

Dräger X-plore® 6570 Full-Face Mask





The Dräger X-plore® 6570 is the high comfort silicone full face mask used by professionals in a wide variety of applications. It meets the highest demands for quality, reliability, secure fit and comfort. This full face mask is the successor to the Panorama Nova masks, a range which has proven itself over decades of use worldwide



ST7500-2006



MASKS & FILTERS

DRÄGER X-PLORE® FULL FACE MASKS OVERVIEW

Description	TWIN-FILTER FULL FACE MASKS (BAYONET CONNECTION)		SINGLE-FILTER FULL FACE MASKS (RD40 CONNECTION)		
	Dräger X-plore® 5500	Dräger X-plore® 5500	Dräger X-plore® 6300	Dräger X-plore® 6500	Dräger X-plore® 6530
					
	ST-689-2002	ST-944-2008	ST-7497-2005	ST-7498-2005	ST-14949-2008
	Dräger X-plore® 5500 EPDM / PC	Dräger X-plore® 5500 EPDM / Triplex	Dräger X-plore® 6300 EPDM / PMMA	Dräger X-plore® 6530 EPDM / PC	Dräger X-plore® 6530 EPDM / PC
Order-No.	R 55 270	R 56 655	R 55 800	R 55 795	R 51 525
Mask Body Material	EPDM / black	EPDM / black	EPDM / black	EPDM / black	EPDM / black
Lens Material	PC	Triplex	PMMA	PC	PC
Lens Frame Style	plastic / blue	metal	plastic / blue	plastic / blue	metal
Speech Diaphragm	plastic	plastic	plastic	stainless steel	stainless steel
Exhalation Valve Cover	black	black	blue	black	black
Neck Strap (PVC)	no	no	no	yes	yes
EN 136 Approval	class 2	class 2	class 2	class 3	class 3
NIOSH Approval	X	X	X	X	X
Approval for Fire Brigade				X	

Place You Put Your Faith

SINGLE-FILTER FULL FACE MASKS
(RD40 CONNECTION)

Description	Dräger X-plore® 6570		
			
	ST-7501-2005	ST-14949-2008	ST-7500-2005
	Dräger X-plore® 6570 SI / PC	Dräger X-plore® 6570 SI / PC	Dräger X-plore® 6570 SI / Triplex
Order-No.	R 55 790	R 51 535	R 55 850
Mask Body Material	silicone / blue	silicone / yellow	silicone / yellow
Lens Material	PC	PC	Triplex
Lens Frame Style	plastic / black	metal	metall
Speech Diaphragm	stainless steel	stainless steel	stainless steel
Exhalation Valve Cover	black	black	black
Neck Strap (PVC)	no	no	no
EN 136 Approval	class 3	class 3	class 3
NIOSH Approval	X	X	
Approval for Fire Brigade	X		X

MASKS & FILTERS

PRODUCT	DESCRIPTION	PART NO	PACKAGING UNIT/TYPE	CATEGORY
---------	-------------	---------	---------------------	----------

X-PLORE 6000 SERIES SINGLE FILTER RD 40 MASKS

X-plore 6000 Full Face Mask Series - For Single Filter RD 40

The X-plore 6000 range is our traditional full face mask design. Suitable for applications within all areas of industry. Large field of vision with the Panorama-visor. No fogging by optimal air circulation. Long lifetime from high quality materials. This mask is available in different versions and can also be used in combination with powered air purifying respirators, filters, airline systems or even with compressed air breathing apparatus.



1. X-plore 6300 EPDM PMMA		R55800	1 / box	A
2. X-plore 6530 EPDM PC	Comes with Neck Strap	R55795	1 / box	A
3. X-plore 6530 EPDM PC	Comes with Neck Strap	R51525	1 / box	A
4. X-plore 6530 EPDM Triplex Glass	Comes with Neck Strap	R55810	1 / box	A
5. X-plore 6570 Si PC		R55790	1 / box	A
6. X-plore 6570 Si PC		R51535	1 / box	A
7. X-plore 6570 Si Triplex Glass		R55850	1 / box	A

Spare Parts

Headstrap EPDM	Replacement Headstrap (no buckles)	R26279	1 / box	H
Headstrap Silicone Blue	Replacement Headstrap (no buckles)	R55852	1 / box	H
Headstrap Silicone Yellow	Replacement Headstrap (no buckles)	R50282	1 / box	H
Plexiglass (PMMA) Visor	Replacement PMMA Visor	R26470	1 / box	H
Polycarbonate (PC) Visor	Replacement PC Visor	R50833	1 / box	H
Triplex Glass Visor	Replacement Triplex Glass Visor	R26989	1 / box	H
Neck Strap	PVC Neckstrap	R51772	1 / box	H

PMMA - Plexiglass

PC - Polycarbonate

Triplex (L) - Triplex Laminated Glass

EPDM - Ethylene propylene diene terpolymer

Si - Silicone

Dräger Region South East Europe | Rev: 0 | Subject to modification! | www.draeger.com

Place You Put Your Faith

PORTABLE
GAS DETECTION

PERSONAL
PROTECTION
EQUIPMENT

DRUG & ALCOHOL
DETECTION

MASKS & FILTERS

FIRE & GAS
DETECTION
SYSTEMS

ENGINEERED
SOLUTIONS

SERVICE,
TRAINING & RENTAL

DIVING
TECHNOLOGY

MASKS & FILTERS

PRODUCT	DESCRIPTION	PART NO	PACKAGING UNIT/TYPE	CATEGORY
---------	-------------	---------	---------------------	----------

X-PLORE 6000 SERIES SINGLE FILTER RD 40 MASKS

Material Characteristics	Plexiglass	Polycarbonate	Triplex Glass	EPDM	Silicone
Shock, impact	2	1	3		
Flection	3	1	4		
Heat	up to 80°C	up to 125 °C	up to 200°C	3	1
Abrasion	2	3	1	2	2
Agressive Chemicals (eg.phosgene, H2S)	4	3	1	1	5
Elasticity				2	1
Tear Strength Values				2	2
Tensile Strength				2	3
Flame				2	3
Flexibility when cold				2	1
Solvents				2	1

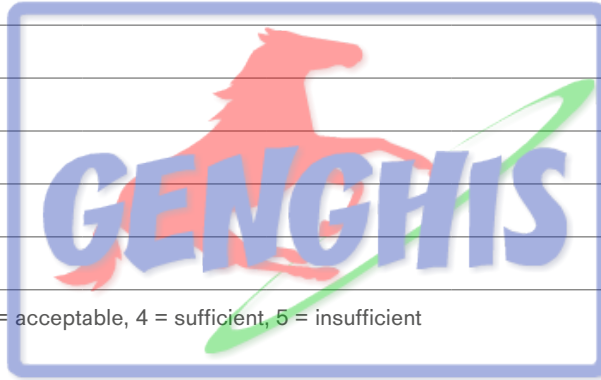

Legend - 1 = very good, 2 = good, 3 = acceptable, 4 = sufficient, 5 = insufficient

Place You Put Your Faith

Dräger FPS® 7000 Full Face Mask

The Dräger FPS® 7000 full-face mask series sets new standards in terms of safety and wearing comfort. Thanks to its enhanced ergonomics and the availability of multiple sizes, it offers a large, optimized field of vision and a very comfortable, secure fit.

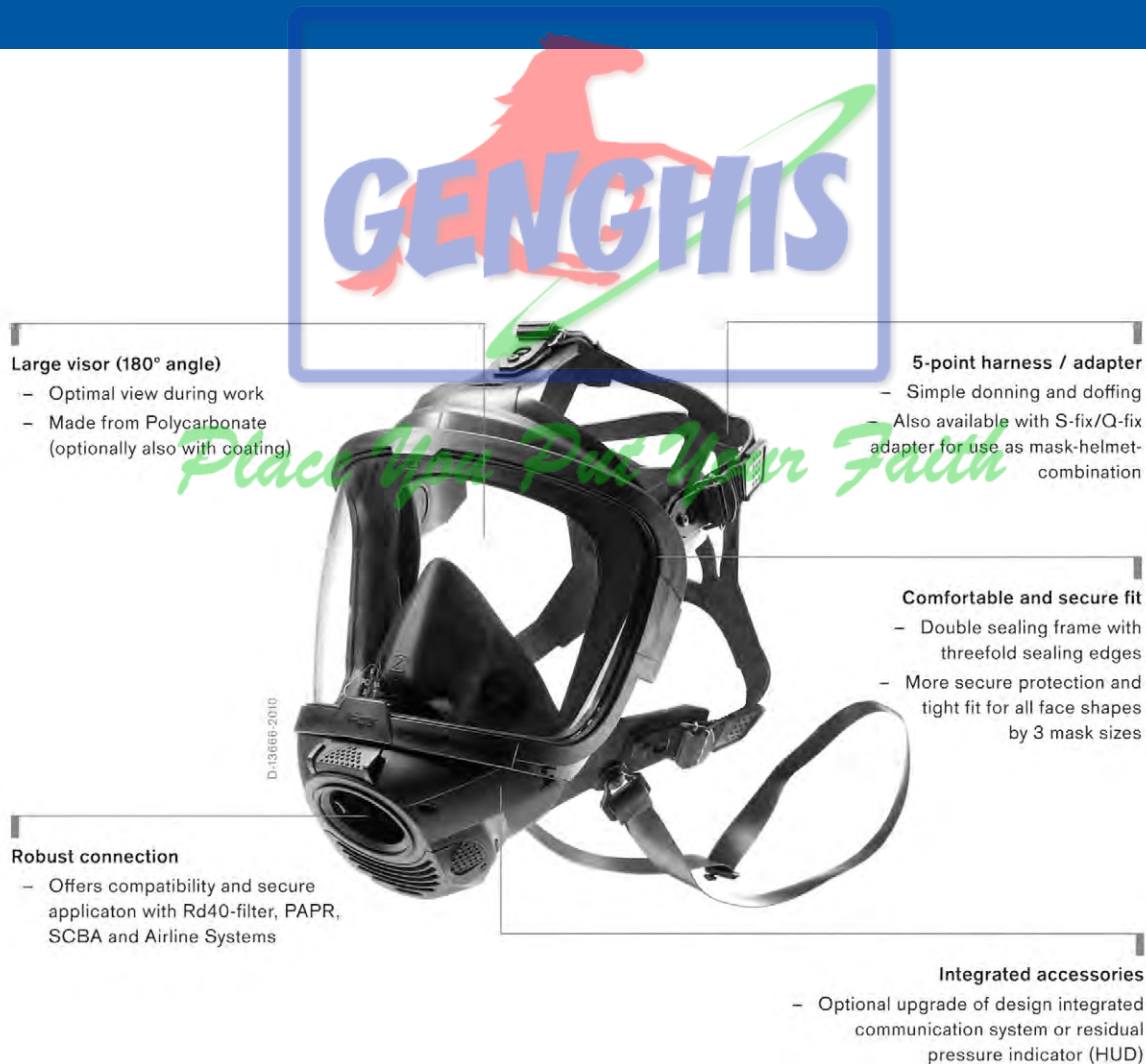

Dräger FPS®-COM 5000 Communication Unit

In an emergency, there is no time for misunderstanding. That's why Dräger developed the FPS-COM 5000 communication unit. Designed to connect seamlessly to the Dräger FPS® 7000 and FPS® 7000 RP full face masks, this proven communication unit ensures clear communication through either a voice amplifier or a radio—even in extreme conditions.

High-visibility LED

Displays battery status when low, even in the harshest conditions

Dual side speakers

Deliver high volume sound directed toward the listener

Flexible gooseneck earpiece

Easily adjusts to conform to your head for maximum voice audibility

Radio device connection cable

Connects to various communication radios and lapel microphones/push-to-talk units



MASKS & FILTERS

PRODUCT	DESCRIPTION	PART NO	PACKAGING UNIT/TYPE	CATEGORY
---------	-------------	---------	---------------------	----------

FPS 7000 SERIES SINGLE FILTER RD40 MASKS

FPS 7000 Series - For Single Filter RD 40

The FPS 7000 is the most modern mask within the full face mask range. The modular concept incorporating S, M & L sizes of outer and inner mask ensure the best fit and wearing comfort. Mask body made of EPDM or Silicone whilst the inner mask is made of TPE.

Wide field of vision through the visor made of very flexible shock- and heat-resistant polycarbonate, fixed in the glass-fibre reinforced plastic frame. No fogging by optimal air circulation. Capton foil speech diaphragm for higher clarity speech. Neck Strap Included.



1. FPS 7000 EPDM Small	EPDM	R56502	1 / box	A
1. FPS 7000 EPDM Medium	EPDM	R56310	1 / box	A
1. FPS 7000 EPDM Medium AV	EPDM, Anti-Scratch Visor	R57823	1 / box	A
1. FPS 7000 Si Medium	Silicone	R56332	1 / box	A
1. FPS 7000 EPDM Large	EPDM	R56503	1 / box	A
1. FPS 7000 Custom Made to order *matrix required to be completed	A matrix allows the following customisations: mask body EPDM/Si, head harness EPDM/Si/ Hairnet, neck strap PVC/Elastic, Visor coatings anti-scratch/anti-fog, helmet connectors and outer and inner mask sizes S/M/L	R56415	1 / box	A

Material Characteristics	Polycarbonate	EPDM	Silicone
Shock, impact	1		
Flection	1		
Heat	up to 125 °C	3	1
Abrasion	3	2	2
Agressive Chemicals (eg.phosgene, H2S)	3	1	5
Elasticity		2	1
Tear Strength Values		2	2
Tensile Strength		2	3
Flame		2	3

Legend - 1 = very good, 2 = good, 3 = acceptable, 4 = sufficient, 5 = insufficient

EPDM - Ethylene propylene diene terpolymer

Si - Silicone

PC - Polycarbonate

Dräger Region South East Europe | Rev: 0 | Subject to modification! | www.draeger.com

Place Your Faith

PORTABLE
GAS DETECTION

PERSONAL
PROTECTION
EQUIPMENT

DRUG & ALCOHOL
DETECTION

MASKS & FILTERS

FIRE & GAS
DETECTION
SYSTEMS

ENGINEERED
SOLUTIONS

SERVICE,
TRAINING & RENTAL

DIVING
TECHNOLOGY

MASKS & FILTERS

PRODUCT	DESCRIPTION	PART NO	PACKAGING UNIT/TYPE	CATEGORY
---------	-------------	---------	---------------------	----------

FPS 7000 SERIES SINGLE FILTER RD40 MASKS

FPS 7000 Com Series - For Single Filter RD 40

The FPS 7000 Com 5000 & 7000 masks allow users to communicate via radio. The 5000 requires each person to wear an external radio which is connected to the mask via a push-to-talk button. The 7000 has an inbuilt radio in the mask so users can communicate via 'team talk' without needing an additional radio. If they want to communicate with someone not wearing a 7000 mask but with an external radio, then one user of the 7000 needs to be connected to a radio as well.



1. FPS 7000 with FPS-Com 5000 *matrix required to be completed	Radio & Voice Amplification attachment with the above options available. External radio & push-to-talk button required*	R62701	1 / box	D
1. FPS 7000 EPDM Medium with FPS-Com 5000 with Neck Strap, with external radio connection	Pre-configured version for easy ordering. Push-to-talk button required*	TBA	1 / box	D
2. FPS 7000 with FPS-Com 7000 *matrix required to be completed	Radio & Voice Amplification attachment with the above options available. Radio built into mask for team talk	R61350	1 / box	D
2. FPS 7000 EPDM Medium with FPS-Com 7000 with Neck Strap, no external radio connection	Pre-configured version for easy ordering	TBA	1 / box	D

*Contact the product manager with the radio model to identify a suitable push-to-talk button

Spare Parts

Headstrap EPDM	Replacement Headstrap (no buckles)	R61071	1 / box	G
Headstrap Silicone	Replacement Headstrap (no buckles)	R54662	1 / box	G
Visor Polycarbonate	Replacement Visor	R56223	1 / box	G
Visor Polycarbonate Anti-Scratch	Replacement Visor	R56288	1 / box	G
Visor Polycarbonate Anti-Fog	Replacement Visor	R56291	1 / box	G
Neck Strap	PVC Neckstrap	R51772	1 / box	G

MASKS & FILTERS

PRODUCT	DESCRIPTION	PART NO	PACKAGING UNIT/TYPE	CATEGORY
---------	-------------	---------	---------------------	----------

X-PLORE 6000 & FPS 7000 SERIES SINGLE FILTER RD40 MASKS

Accessories



1. Mask Disinfectant Wipes	For quick cleaning of masks (10pcs)	R54134	1 / box	D
3. Wikov V Transport Case	For the X-plore 6000 with filter attached	R51019	1 / box	D
4. Mabox 2 Transport Case	For the FPS 7000 with NO filter connected	R54610	1 / box	D
4. Mabox 1 Transport Case	For the FPS 7000 with filter connected	R53680	1 / box	D
6. Visor covers / Lens protectors	X-plore only self-adhesive lens covers (25pcs). 1 cover attaches at a time via 2 adhesive strips	4055092	1 / box	D
7. X-plore Spectacle Frame	Insert for the X-plore Full Face Masks. Lenses to be fitted by a local optometrist	R51548	1 / box	D
8. FPS Spectacle Frame	Insert for the FPS Full Face Masks. Lenses to be fitted by a local optometrist	R56230	1 / box	D
9. FPS Spectacle Frame Adaptor	Allows you to use the X-plore spectacle frame inside the FPS full face mask range. PERMANENT CHANGE!	R56799	1 / box	D
11. Klar-Pilot gel (50 ml)	Klar-Pilot prevents visors and mask spectacles from fogging even in case of extreme temperature differences.	R52560	1 / box	D
12. Klar-Pilot spray (50 ml)	Like Klar-Pilot gel, but as a spray. Especially for anti-scratch & anti-fog coated visors	R56542	1 / box	D

MASKS & FILTERS

PRODUCT	DESCRIPTION	PART NO	PACKAGING UNIT/TYPE	CATEGORY
---------	-------------	---------	---------------------	----------

X-PLORE 6000 & FPS 7000 SERIES SINGLE FILTER RD40 MASKS

Accessories



1. Welding Attachment	X-plore 6000 with metal visor frames only. Welding adaptor required.	4053437	1 / box	D
2. Welding Attachment	FPS 7000 only. Welding adaptor required.	R58707	1 / box	D
3. Welding Adapter	Frame for the welding attachment to fit the protective welding filter/lens	R57308	1 / box	D
4. Welding filter no 9		R55349	10 / box	A
4. Welding filter no 10		R55052	10 / box	A
4. Welding filter no 11		R55078	10 / box	A
4. Welding filter no 12		R55468	10 / box	A
4. Welding filter no 13		R55429	10 / box	A
5. Welding filter, auto-darkening	Default shade level of 3 and then changes to 11 when welding	R55353	1 / box	A
6. Welding filter, auto-darkening	Default shade level of 4 and then changes to 9-13 when welding	R57635	1 / box	A
Protective plate Outside	polycarbonate	R55118	10 / box	A

MASKS & FILTERS

PRODUCT	DESCRIPTION	PART NO	PACKAGING UNIT/TYPE	CATEGORY
---------	-------------	---------	---------------------	----------

SINGLE FILTER RD 40 TYPE

RD 40 Filters

The RD 40 filter range has the largest selection of filter options. It suits the X-plore 4740, X-plore 6000 Series and FPS 7000.



RD 40 Particle Filters

1. 1140 P3 R (incinerable)		6738932	1 / box	A
----------------------------	--	---------	---------	---

RD 40 Gas Filters

2. 940 A2	A	6738855	1 / box	A
2. 940 A2B2	A B	6738779	1 / box	A
2. 1140 AX	AX	6738863	1 / box	A
2. 1140 AXB2*	AX B	6738782	1 / box	A
2. 940 K2	K	6738856	1 / box	A
2. 940 A2B2E2K1	A B E K	6738802	1 / box	A
2. 1140 A2B2E2K2*	A B E K	6738804	1 / box	A

* For full face masks only, weight >300g

Pricing is per filter. Minimum order of 1 box

R - Reusable (not limited to 1 shift)

940 - 9cm wide filter housing, 40mm wide thread

1140 - 11cm wide filter housing, 40mm wide thread

Did you know that Draeger has an online database where you can check what the correct filter is for each hazardous substance?

<http://www.draeger.net/voice/default.do?country=MH&language=en>

MASKS & FILTERS

PRODUCT	DESCRIPTION	PART NO	PACKAGING UNIT/TYPE	CATEGORY
---------	-------------	---------	---------------------	----------

SINGLE FILTER RD 40 TYPE

RD 40 Filters

The RD 40 filter range has the largest selection of filter options. It suits the X-plore 4740, X-plore 6000 Series and FPS 7000.



RD 40 Gas & Particle Filters

1. 940 A2 P2 R D	A	P	6738857	1 / box	A
1. 1140 A2 P3 R D	A	P	6738860	1 / box	A
1. 940 A2B2 P2 R D	A B	P	6738780	1 / box	A
1. 1140 A2B2 P3 R D	A B	P	6738783	1 / box	A
1. 1140 AX P3 R D	AX	P	6738862	1 / box	A
1. 940 K2 P2 R D	K	P	6738858	1 / box	A
1. 940 A2B2E2K1 P2 R D	A B E K Hg	P	6738803	1 / box	A
1. 1140 A2B2E2K1 Hg P3 R D	A B E K Hg	P	6738815	1 / box	A
1. 1140 A2B2E2K2 Hg P3 R D*	A B E K Hg	P	6738797	1 / box	A
1. 1140 A1B2E2K1 Hg NO CO 20 P3 R D*	A B E K Hg NO CO	P	6738801	1 / box	A
1. 1140 A2B2E2K2 Hg NO CO 20 P3 R D*	A B E K Hg NO CO	P	6738814	1 / box	A

* For full face masks only, weight >300g

Pricing is per filter. Minimum order of 1 box

R - Reusable (not limited to 1 shift)

D - Successfully passed the dolomite dust test against clogging to maintain low breathing resistance in high dust concentrations

940 - 9cm wide filter housing, 40mm wide thread

1140 - 11cm wide filter housing, 40mm wide thread

Did you know that Draeger has an online database where you can check what the correct filter is for each hazardous substance?

<http://www.draeger.net/voice/default.do?country=MH&language=en>

Dräger X-plore® 4700 Half Mask

The Dräger X-plore® 4700 is the robust half mask which offers excellent comfort and outstanding leak tightness for demanding applications. Thanks to the wide range of filters available for protection against gases, vapours and particles, it is ideally suited for use in a variety of industries.



MASKS & FILTERS

PRODUCT	DESCRIPTION	PART NO	PACKAGING UNIT/TYPE	CATEGORY
---------	-------------	---------	---------------------	----------

X-PLORE 4790 RD 90 FILTER MASKS

X-plore 4700 Half Mask Series

The X-plore 4790 is a reusable half mask designed with a 90mm filter to reduce breathing resistance and improve comfort. This range of filters can only be used on this half mask. No full face mask available.



1. X-plore® 4790 TPE M/L	TPE	R55879	1 / box	A
2. X-plore® 4790 Si S/M	Silicone	R55878	1 / box	A
2. X-plore® 4790 Si M/L	Silicone	R55877	1 / box	A
3. X-plore® 4790 Si EH S/M	Silicone. Elastic head harness without neck hooks	R56720	1 / box	A
3. X-plore® 4790 Si EH M/L		R56715	1 / box	A

Si - Silicone

TPE - Thermoplastic elastomer

TPE or Silicone, which one should I pick?

There are some advantages and disadvantages to both; it just depends on the application/situation. Silicone is usually not allowed in paint areas as silicone material can affect the finish of paint (causing "fish-eye"), and aggressive chemicals (e.g. hydrogen sulphide) can permeate through silicone. Because silicone is porous, you must thoroughly rinse it after disinfecting (think longer maintenance). Also, silicone is very slippery when it gets wet from sweat, thus causing it to slide around, which in turn can cause leaks. On the flip-side, silicone is very comfortable, cleans up easily due to smooth surface and holds up very well in extreme cold temperatures. TPE fits well in situations where silicone has disadvantages.



Material Characteristics	Silicone	TPE
Elasticity	1	2
Tear Strength Values	2	3
Abrasion	2	2
Tensile Strength	3	4
Heat	1	5
Flame Resistance	3	4
Flexibility when cold	1	3
Solvents	1	4
Aggressive Chemicals (eg. phosgene, H2S)	5	-

1 = very good, 2 = good, 3 = acceptable, 4 = sufficient, 5 = insufficient

MASKS & FILTERS

PRODUCT	DESCRIPTION	PART NO	PACKAGING UNIT/TYPE	CATEGORY
---------	-------------	---------	---------------------	----------

X-PLORE 4790 RD 90 FILTER MASKS

Spare Parts				
Headharness	Complete headharness & straps	R55224	1 / box	H
Elastic Headstrap	Complete headstrap	R56723	1 / box	H
Yoke	Blue plastic front cover	R53321	1 / box	H
Inhalation valve disc	Replacement inhalation valve	R53309	10 / box	H
Exhalation valve disc	Replacement exhalation valve	RM05064	10 / box	H
Accessories				
				
1. Wikru Storage and Transport Box	Suits half face masks, not with filter attached			
2. Mask Disinfectant Wipes	For quick cleaning of masks (10pcs)	R54134	1 / box	D

Place You Put Your Faith

Dräger X-plore® Rd90 Filters Filter

Clean air for tough jobs. The filters of the Dräger X-plore® Rd90 series protect from hazardous gases and vapors, have a long life and can be used for many different masks.

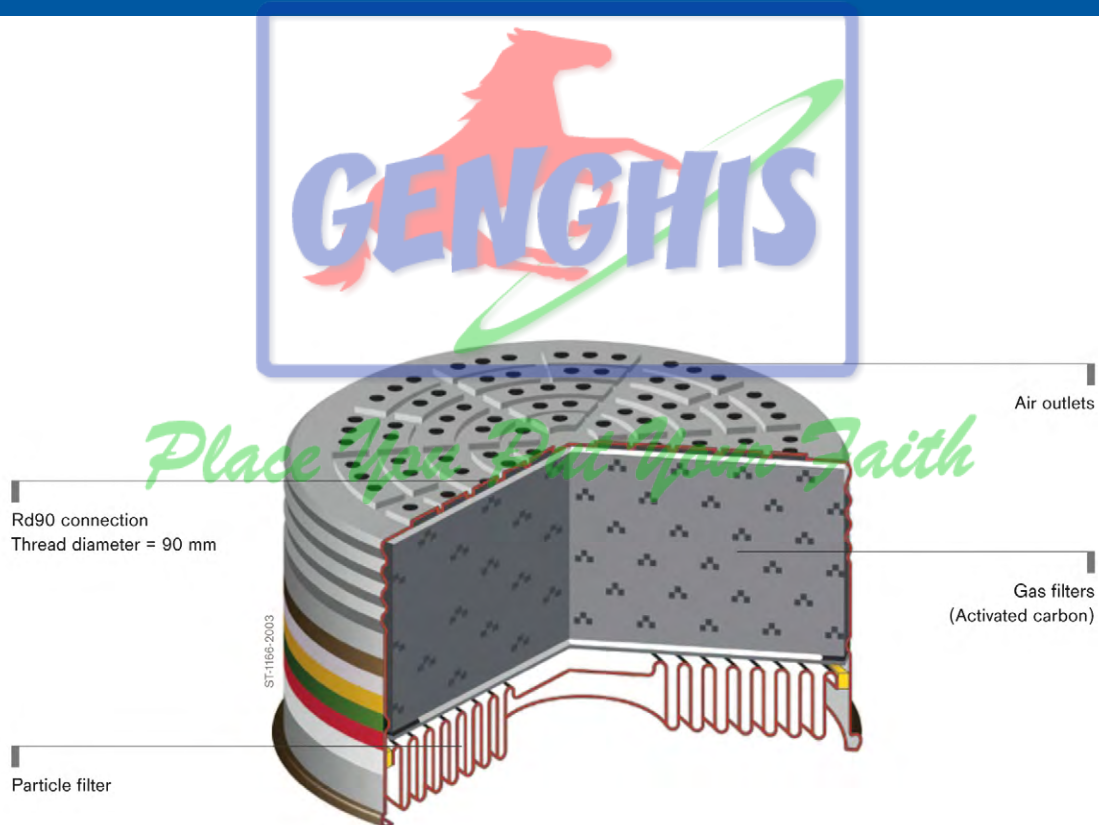

MASKS & FILTERS

PRODUCT	DESCRIPTION	PART NO	PACKAGING UNIT/TYPE	CATEGORY
---------	-------------	---------	---------------------	----------

SINGLE FILTER RD 90 TYPE

The RD 90 filter range offers the lowest breathing resistance due to the increased diameter. It suits the X-plore 4790 mask only.

RD 90 Gas Filter



RD 90 Particle Filter

1. 990 P2 R		P	6737357	5 / box	A
1. 990 P3 R		P	6737190	5 / box	A
2. 990 Prefilter	To extend the life of the main filter		6736705	50 / box	A

RD 90 Gas Filter

3. 990 A1	A		6738865	5 / box	A		
3. 990 A2	A		6738866	5 / box	A		
3. 990 A1B1E1K1	A	B	E	K	6738810	5 / box	A

RD 90 Combination Filter

4. 990 A1 P2 R D	A		P	6738867	5 / box	A			
4. 990 A2 P3 R D	A		P	6738870	5 / box	A			
4. 990 A1B1 P2 R D	A	B	P	6738774	5 / box	A			
4. 990 A2B2 P2 R D4	A	B	P	6738771	5 / box	A			
4. 990 A2B2 P3 R D	A	B	P	6738773	5 / box	A			
4. 990 B1E1 P2 R D	B	E	P	6738770	5 / box	A			
4. 990 A1B1E1K1 P2 R D	A	B	E	K	P	6738811	5 / box	A	
4. 990 A1B1E1K1 Hg P3 R D4	A	B	E	K	Hg	P	6738812	5 / box	A

Accessories

5. Filter Adaptor 40/90	Adaptor to use RD90 filters with an RD 40 mask	R55015	5 / box	A
-------------------------	--	--------	---------	---

Pricing is per filter/adaptor. Minimum order of 1 box

R - Reusable (not limited to 1 shift)

D - Successfully passed the dolomite dust test against clogging to maintain low breathing resistance in high dust concentrations

Did you know that Draeger has an online database where you can check what the correct filter is for each hazardous substance?

<http://www.draeger.net/voice/default.do?country=MH&language=en>

Draeger Region South East Europe | Rev: 0 | Subject to modification! | www.draeger.com

Place You Put Your Faith

PORTABLE
GAS DETECTION

PERSONAL
PROTECTION
EQUIPMENT

DRUG & ALCOHOL
DETECTION

MASKS & FILTERS

FIRE & GAS
DETECTION
SYSTEMS

ENGINEERED
SOLUTIONS

SERVICE,
TRAINING & RENTAL

DIVING
TECHNOLOGY

MASKS & FILTERS

Dräger X-plore® 8000

The system at a glance

Place You Put Your Faith



Dräger X-plore® 8000 Powered Air-Purifying Respirator (PAPR)

Workplace environments that compromise the quality of air you breathe demand reliable solutions. The Dräger X-plore® 8000 powered air-purifying respirator (PAPR) offers a new level of intuitive handling combined with intelligent electronics. The result? A high degree of safety that you and your people need to focus on the task at hand.



Intelligent alarm system
Two-level alarm design with differentiation of risk level

Lithium-ion technology
Operating time between 4 and 20 hours depending on the working conditions and system set-up

IP65 protection
Optimal protection and easy decontamination

Filter recognition
Advanced sensor technology recognizes the correct filter and displays particle filter saturation properly

Hose identification
Automatic adjustment of minimum flow rate for attached headpiece

MASKS & FILTERS

PRODUCT	DESCRIPTION	PART NO	PACKAGING UNIT/TYPE	CATEGORY
---------	-------------	---------	---------------------	----------

X-PLORE 8000 SERIES POWERED AIR PURIFYING RESPIRATOR (PAPR)

The Dräger X-plore 8500 is designed for use in non-hazardous areas. It utilises sensors for the filter and breathing hose to ensure safe operation at all times. It's heavy-duty design incorporates rubber protectors and it's rated to IP65 as dust proof and water resistant.

The X-plore 8000 automatically adjusts the air flow for the head piece connected and also allows a manual adjustment of the airflow in 3 stages. Advanced sensor technology detects the filters used and displays the saturation of the particle filter.

X-plore 8500 Kits



X-plore 8500 Basic Kit

- Requires breathing hose, head piece & Filter

Includes Xplore 8500, High capacity battery, charger, belt & comfort pad.

R59540

1 / box

A

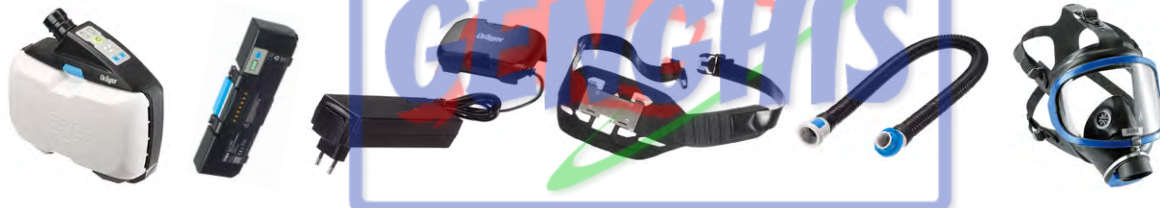

X-plore 8500 Decontamination Complete Kit

Includes X-plore 8500, Standard capacity battery, charger, decon belt, breathing hose, Xplore 6300 mask and P3 filter.

R59570

1 / box

A

Place Your Faith

MASKS & FILTERS

PRODUCT	DESCRIPTION	PART NO	PACKAGING UNIT/TYPE	CATEGORY
---------	-------------	---------	---------------------	----------

X-PLORE 8000 SERIES POWERED AIR PURIFYING RESPIRATOR (PAPR)

The Dräger X-plore 8700 is designed for use in hazardous areas and is certified to IECEx. It utilises sensors for the filter and breathing hose to ensure safe operation at all times. It's heavy-duty design incorporates rubber protectors and it's rated to IP65 as dust proof and water resistant. The X-plore 8000 automatically adjusts the air flow for the head piece connected and also allows a manual adjustment of the airflow in 3 stages. Advanced sensor technology detects the filters used and displays the saturation of the particle filter.

X-plore 8700 Kits - For use in hazardous (flammable/explosive) areas

	<p>X-plore 8700 Basic Kit</p> <ul style="list-style-type: none"> Requires breathing hose, head piece & Filter 	<p>Includes X-plore 8700, standard capacity battery, charger & belt.</p>	<p>R59990</p>	<p>1 / box</p>	<p>A</p>
	<p>X-plore 8700 Premium Kit</p> <ul style="list-style-type: none"> Requires breathing hose, head piece & Filter 	<p>Includes X-plore 8700, High capacity battery, charger, belt & comfort pad.</p>	<p>R59560</p>	<p>1 / box</p>	<p>A</p>

MASKS & FILTERS

PRODUCT	DESCRIPTION	PART NO	PACKAGING UNIT/TYPE	CATEGORY
---------	-------------	---------	---------------------	----------

X-PLORE 8000 SERIES POWERED AIR PURIFYING RESPIRATOR (PAPR)

Blower unit and accessories



1. X-plore 8500 Base Unit	Blower unit and splash guard only	R59500	1 / box	A
2. X-plore 8500 Standard Battery	Li-ion battery lasts 4 – 10 hours	R59565	1 / box	A
2. X-plore 8500 High-capacity Battery	Li-ion battery lasts 8 – 20 hours	R59585	1 / box	A
3. X-plore 8700 Base Unit	Intrinsically Safe for use in potentially explosive areas	R59550	1 / box	A
2. X-plore 8700 Standard Battery	Li-ion battery lasts 4 – 10 hours	R59575	1 / box	A
2. X-plore 8700 High-capacity Battery	Li-ion battery lasts 8 – 20 hours	R59595	1 / box	A
4. Standard Charger	Charge in under 4 hours	R59580	1 / box	A
Multi-Unit Charger	1 Module with Aus power cable	R59970	1 / box	A
Multi-Unit Charger	1 Module without cable. Up to 5 modules can be connected together to charge from one powerpoint	R59890	1 / box	A
5. Case	Plastic storage/transport case with foam cutout inner. that fits everything excluding headpiece	R59690	1 / box	A
6. Softshell Bag	Softshell carry bag for a complete set including headpiece	R58555	1 / box	A
7. Hose cover	Disposable protective cover for all hoses	R59670	10 / box	A

Spare Parts

Splash Guard	White Cover	6739725	1 / box	H
Blower O-Ring		R59631	10 / box	H

How long will each type of battery last depending on the headpiece?

Filter	Standard battery					
	Half & Full Face Masks			Hoods & Visors		
	115l/min	130l/min	145l/min	170l/min	190l/min	210l/min
P R SL	8.5 h	8 h	6.5 h	9.5 h	8 h	7 h
A2	6.5 h	5.5 h	5 h	7.5 h	6 h	5 h
K2	7 h	6 h	5.5 h	8 h	7 h	6.5 h
A2 P R SL	6 h	5 h	4.5 h	6.5 h	6h	5.5 h
A1B1E1 P R SL	6.5 h	5.5 h	5 h	7.5 h	6 h	5 h
A1B1E1K1 Hg P R SL	6 h	5 h	4.5 h	6.5 h	6 h	5.5 h

Filter	High capacity battery					
	Half & Full Face Masks			Hoods & Visors		
	115l/min	130l/min	145l/min	170l/min	190l/min	210l/min
P R SL	17 h	16 h	13 h	19 h	16 h	14 h
A2	13 h	11 h	10 h	15 h	12 h	10.5 h
K2	14 h	12 h	11 h	16 h	13 h	12.5 h
A2 P R SL	12 h	10 h	9 h	13 h	12 h	11 h
A1B1E1 P R SL	13 h	11 h	10 h	15.5 h	13.5 h	10 h
A1B1E1K1 Hg P R SL	12 h	10 h	9 h	13 h	12 h	11 h

Dräger Region South East Europe | Rev: 0 | Subject to modification! | www.draeger.com

Place You Put Your Faith

PORTABLE
GAS DETECTIONPERSONAL
PROTECTION
EQUIPMENTDRUG & ALCOHOL
DETECTION

MASKS & FILTERS

FIRE & GAS
DETECTION
SYSTEMSENGINEERED
SOLUTIONSSERVICE,
TRAINING & RENTALDIVING
TECHNOLOGY

MASKS & FILTERS

PRODUCT	DESCRIPTION	PART NO	PACKAGING UNIT/TYPE	CATEGORY
---------	-------------	---------	---------------------	----------

X-PLORE 8000 SERIES POWERED AIR PURIFYING RESPIRATOR (PAPR)

Carrying system

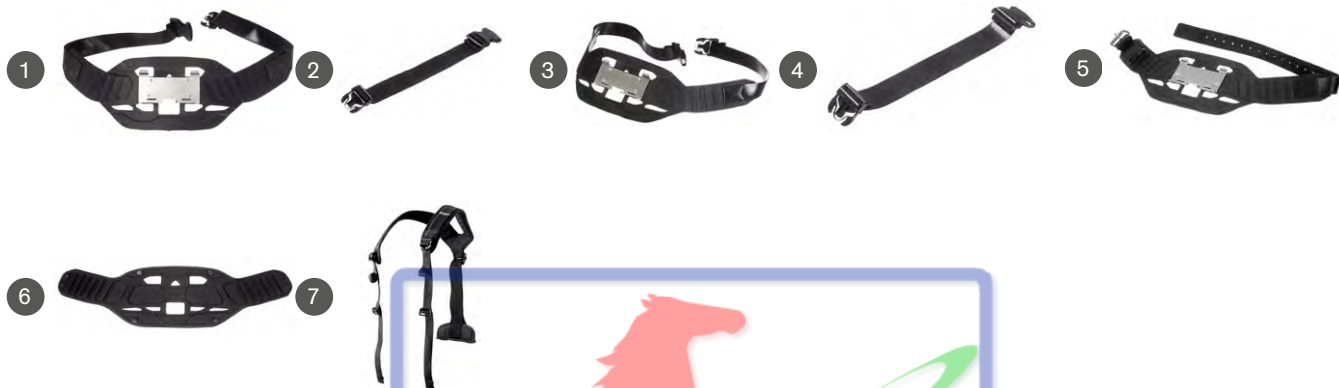

1. Standard belt	Textile belt	R59700	1 / box	A
2. Standard belt extension	Adds an additional 35cm of length	R59750	1 / box	A
3. Decon belt	Plastic belt for easy washdown	R59710	1 / box	A
4. Decon belt extension	Adds an additional 35cm of length	R59760	1 / box	A
5. Welding belt	Leather belt	R59720	1 / box	A
6. Comfort pad	Padding for belts	R59730	1 / box	A
7. Shoulder harness	Transfers weight onto shoulders	R59740	1 / box	A

Dräger X-plore® 8000 headpieces: Hoods, helmets, visors and masks

The more comfortable you are, the better you can do your job. The innovative Dräger X-plore® 8000 headpieces are an integral part of our new powered air-purifying respirator (PAPR). Both the loose- and tight-fitting series offer robust, effective protection along with a high degree of comfort.

Low-noise material

Standard and premium hoods are made of soft and comfortable low-noise material

Low distortion

Spacer on top of the visor gives the visor a defined curvature to reduce distortion

High protection level

All hoods approved as TH3

Secure fit

Comfortable fit even when you are moving, due to ergonomic design

Guided air inlet

Wind deflector inside the hose connector leads the air away from your head to eliminate feeling cold at a single spot

Perfect fit

All hoods available in two different sizes



MASKS & FILTERS

PRODUCT	DESCRIPTION	PART NO	PACKAGING UNIT/TYPE	CATEGORY
---------	-------------	---------	---------------------	----------

X-PLORE 8000 HOODS

Headpieces & Hoses



Hoods

1. Standard breathing hose		R59620	1 / box	A
2. Flexible breathing hose		R59600	1 / box	A
3. Standard hood short (S/M)		R59800	1 / box	A
3. Standard hood short (L/XL)		R59810	1 / box	A
4. Standard hood long (S/M)		R59820	1 / box	A
4. Standard hood long (L/XL)		R59830	1 / box	A
5. Premium hood short (S/M)		R59840	1 / box	A
5. Premium hood short (L/XL)		R59850	1 / box	A
6. Premium hood long (S/M)		R59860	1 / box	A
6. Premium hood long (L/XL)		R59870	1 / box	A
7. Tear off visor protectors	For hoods only	R59863	10 / box	A
Tyvek protective hood	To wear under the short or long hood	R55354	1 / box	A

Spare Parts - Hoods

Hood Hose O-Ring		R59631	10 / box	H
Sweatband for Standard hood		R59826	10 / box	H
Sweatband for Premium hood		R59862	10 / box	H

Sizing guide for hoods

S/M - 52 cm to 59 cm

L/XL - 57 cm to 64 cm

The average human head circumference is approximately 55cm in females and 57cm in males.

MASKS & FILTERS

PRODUCT	DESCRIPTION	PART NO	PACKAGING UNIT/TYPE	CATEGORY
---------	-------------	---------	---------------------	----------

X-PLORE 8000 HELMETS AND VISORS

Helmets & Visors



8. Standard hose	for Helmets and Visors	R59640	1 / box	A
9. Flexible hose		R59650	1 / box	A
10. Helmet with visor, black	Pivoting polycarbonate visor	R58325	1 / box	A
11. Helmet with visor, white		R59910	1 / box	A
12. Protective Softshell visor		R59900	1 / box	A
13. Tear off visor protectors	For helmets & visors only	R58328	10 / box	A
14. Hearing protector set	for helmets only	R58329	1 / box	A
Tyvek protective hood	To wear under the helmet or visor	R55354	1 / box	A

Spare Parts - Helmets

Hose O-Ring	Helmet & Visor	R59632	10 / box	H
Polycarbonate Visor	Impact Resistant	R58331	1 / box	H
Acetate Visor	Chemical resistant	R58332	1 / box	H
Face Seal	Material around chin	R58333	1 / box	H
Head Harness	Plastic internal harness	R58334	1 / box	H
Sweatband		R58330	10 / box	H

Spare Parts - Visor

Hose O-Ring	Helmet & Visor	R59632	10 / box	H
Head cover	Material over head	R59903	1 / box	H
Sweatband		R59904	10 / box	H
Polycarbonate Visor	Impact Resistant	R59901	1 / box	H
Face seal	Material around chin	R59902	1 / box	H

MASKS & FILTERS

PRODUCT	DESCRIPTION	PART NO	PACKAGING UNIT/TYPE	CATEGORY
---------	-------------	---------	---------------------	----------

X-PLORE 8000 WELDING HELMET

Welding Helmet



1. Standard hose		R59640	1 / box	A
2. Flexible hose		R59650	1 / box	A
3. Welding Hose cover	Spark proof cover for hose	R59660	1 / box	A
4. Welding visor	with ADF 5-13	R59940	1 / box	A

Spare Parts - Welding Helmet

Protective plate, inner	Spare parts	R59942	1 / box	H
Protective plate, outer	Spare parts	R59943	1 / box	H
ADF 5-13 for X-plore	Spare parts	R59944	1 / box	H
Head cover	Spare parts	R59927	1 / box	H

MASKS & FILTERS

PRODUCT	DESCRIPTION	PART NO	PACKAGING UNIT/TYPE	CATEGORY
---------	-------------	---------	---------------------	----------

X-PLORE 8000 FACE MASKS

Hoses

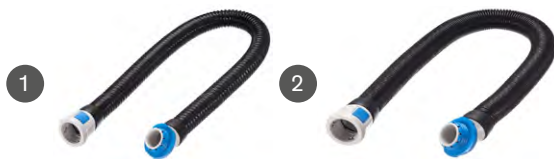

1. Standard hose		R59630	1 / box	A
2. Flexible hose	for Masks with Rd40 connection	R59610	1 / box	A

Half Masks



3. X-plore 4740 TPE M/L	TPE	R55876	1 / box	A
4. X-plore 4740 Si S/M	Silicone	R55875	1 / box	A
4. X-plore 4740 Si M/L	Silicone	R55874	1 / box	A
5. X-plore 4740Si EH M/L	Silicone. Elastic head harness without neck hooks	R56710	1 / box	A

Si - Silicone

TPE - Thermoplastic elastomer

Please see specific product pages of the masks for additional information & spare parts

MASKS & FILTERS

PRODUCT	DESCRIPTION	PART NO	PACKAGING UNIT/TYPE	CATEGORY
---------	-------------	---------	---------------------	----------

X-PLORE 8000 FACE MASKS

Full Face Masks



1. FPS 7000 EPDM Small		R56502	1 / box	A
1. FPS 7000 EPDM Medium		R56310	1 / box	A
1. FPS 7000 EPDM Medium AV	Anti-Scratch Visor	R57823	1 / box	A
1. FPS 7000 Si Medium		R56332	1 / box	A
1. FPS 7000 EPDM Large		R56503	1 / box	A
2. X-plore 6300 EPDM PMMA		R55800	1 / box	A
3. X-plore 6530 EPDM PC	Comes with Neck Strap	R55795	1 / box	A
4. X-plore 6530 EPDM PC	Comes with Neck Strap	R51525	1 / box	A
5. X-plore 6530 EPDM Triplex	Comes with Neck Strap	R55810	1 / box	A
6. X-plore 6570 Si PC		R55790	1 / box	A
7. X-plore 6570 Si PC		R51535	1 / box	A
8. X-plore 6570 Si Triplex		R55850	1 / box	A

PMMA - Plexiglass

PC - Polycarbonate

Triplex - Triplex Laminated Glass

EPDM - Ethylene propylene diene terpolymer

Si - Silicone

Please see specific product pages of the masks for additional information & spare parts

Dräger Region South East Europe | Rev: 0 | Subject to modification! | www.draeger.com

Place You Put Your Faith

PORTABLE
GAS DETECTIONPERSONAL
PROTECTION
EQUIPMENTDRUG & ALCOHOL
DETECTION

MASKS & FILTERS

FIRE & GAS
DETECTION
SYSTEMSENGINEERED
SOLUTIONSSERVICE,
TRAINING & RENTALDIVING
TECHNOLOGY

MASKS & FILTERS

PRODUCT	DESCRIPTION	PART NO	PACKAGING UNIT/TYPE	CATEGORY
---------	-------------	---------	---------------------	----------

X-PLORE 8000 MASK ACCESSORIES

Accessories



1. Mask Disinfectant Wipes	For quick cleaning of masks (10pcs)	R54134	1 / box	D
3. Wikov V Transport Case	For the X-plore 6000 with filter attached	R51019	1 / box	D
4. Mabox 2 Transport Case	For the FPS 7000 with NO filter connected	R54610	1 / box	D
4. Mabox 1 Transport Case	For the FPS 7000 with filter connected	R53680	1 / box	D
6. Visor covers / Lens protectors	X-plore only self-adhesive lens covers (25pcs). 1 cover attaches at a time via 2 adhesive strips	4055092	1 / box	D
7. X-plore Spectacle Frame	Insert for the X-plore Full Face Masks. Lenses to be fitted by a local optometrist	R51548	1 / box	D
8. FPS Spectacle Frame	Insert for the FPS Full Face Masks. Lenses to be fitted by a local optometrist	R56230	1 / box	D
9. FPS Spectacle Frame Adaptor	Allows you to use the X-plore spectacle frame inside the FPS full face mask range	R56799	1 / box	D
11. Klar-Pilot gel (50 ml)	Klar-Pilot prevents visors and mask spectacles from fogging even in case of extreme temperature differences.	R52560	1 / box	D
12. Klar-Pilot spray (50 ml)	Like Klar-Pilot gel, but as a spray. Especially for anti-scratch & anti-fog coated visors	R56542	1 / box	D

MASKS & FILTERS

PRODUCT	DESCRIPTION	PART NO	PACKAGING UNIT/TYPE	CATEGORY
---------	-------------	---------	---------------------	----------

X-PLORE 8000 MASK ACCESSORIES

Accessories



1. Welding Attachment	X-plore 6000 with metal visor frames only. Welding adaptor required.	4053437	1 / box	D
2. Welding Attachment	FPS 7000 only. Welding adaptor required.	R58707	1 / box	D
3. Welding Adapter	Frame for the welding attachment to fit the protective welding filter/lens	R57308	1 / box	D
4. Welding filter no 9		R55349	10 / box	A
4. Welding filter no 10		R55052	10 / box	A
4. Welding filter no 11		R55078	10 / box	A
4. Welding filter no 12		R55468	10 / box	A
4. Welding filter no 13		R55429	10 / box	A
5. Welding filter, auto-darkening	Default shade level of 3 and then changes to 11 when welding	R55353	1 / box	A
6. Welding filter, auto-darkening	Default shade level of 4 and then changes to 9-13 when welding	R57635	1 / box	A
Protective plate Outside	polycarbonate	R55118	10 / box	A

MASKS & FILTERS

PRODUCT	DESCRIPTION	PART NO	PACKAGING UNIT/TYPE	CATEGORY
---------	-------------	---------	---------------------	----------

X-PLORE 8000 FILTERS

Gas & Particle Filters

These filters suit the X-plore 8000 powered air purifying respirator only. Only 1 filter required on the X-plore 8000 at a time.

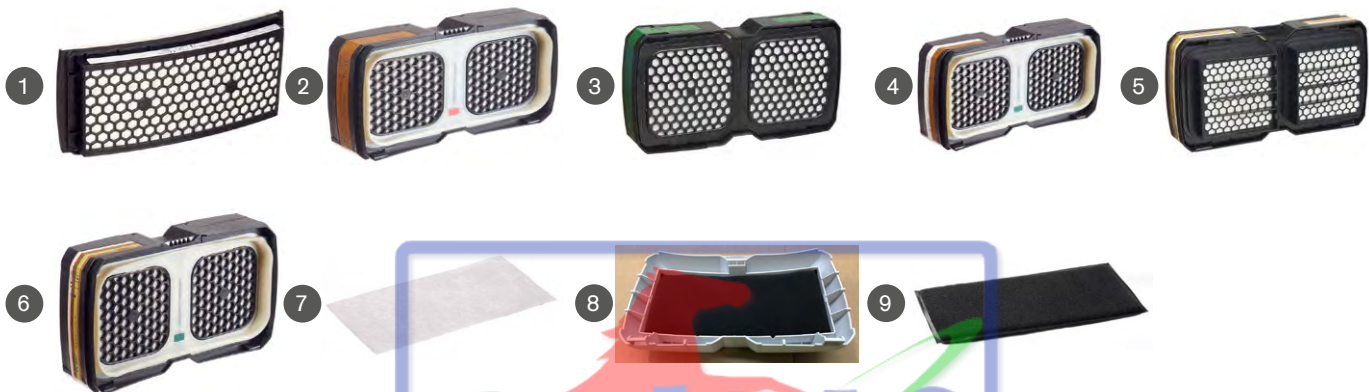

1. P3 R SL		P		6739535	1 / box	A				
2. A2		A		6739580	1 / box	A				
3. K2		K		6739585	1 / box	A				
4. A2 P3 R SL		A		P	6739545	1 / box	A			
5. A1B1E1 P3 R SL		A	B	E	P	6739550	1 / box	A		
6. A1B1E1K1 Hg P3 R SL		A	B	E	K	Hg	P	6739555	1 / box	A
7. X-plore 8000 Particle Prefilter	To extend the life of the particle & combination filters				6739730	10 / box	A			
8. X-plore 8000 Odour Filter set	Odour filter plus a modified splash guard/lid required to use the odour filter				6739735	1 / box	A			
9. X-plore 8000 Odour filter	To be used with particle filters to remove nuisance odour				6739605	10 / box	A			

R - Reusable (not limited to 1 shift)

SL - Approved for use against solid & liquid aerosols

Did you know that Draeger has an online database where you can check what the correct filter is for each hazardous substance?

<http://www.draeger.net/voice/default.do?country=MH&language=en>

Dräger PARAT® 3160 Filtering Escape Device

Dräger PARAT® 3160 half mask escape device with a multi-gas ABEK15 filter is approved to the recognized standard for industrial escape devices (DIN 58647-7). It provides a minimum of 15 minutes escape time. Compared to PARAT® 3100, the half mask and filter are vacuum-sealed in an aluminum barrier bag, making it better suited for tropical climate zones.

Half mask with 2-point harness

- Quick, easy and secure donning in an emergency situation
- Half mask allows for good communication

Integrated belt clip

- For safe and comfortable carrying of the device on the body

Transparent backplate

- A visual inspection of the equipment is possible at all times
- The expiration date of the filter is easy to find

Info label on the inside

- Protected against abrasion
- Info at a glance: easily understood pictograms for the correct and quick donning of the equipment during a hazard



TPE sealing strap

- Easy to open and close: replace filters quickly and easily

Slip-proof holding areas

- Rough surfaces for safe use – also with work gloves

Service life

- Service life of 12 years provided the filter is exchanged after 6 years, and operated in accordance with the intended use

Robust, housing

- Mask and filter are vacuum sealed in a robust foil bag and are additionally protected by the housing
- Suitable for daily use in rough work environments

Dräger PARAT® 3260 Filtering Escape Device

Dräger PARAT® 3260 mouthpiece / nose-clip escape device with a multi-gas ABEK15 filter is approved to the standard for industrial escape devices (DIN 58647-7). It provides a minimum of 15 minutes escape time. Compared to PARAT® 3200, the device and filter are vacuum-sealed in an aluminum barrier bag, making it better suited for tropical climate zones.

Mouthpiece / Nose-clip assembly

- Provides extremely low leakage
- Suited for bearded wearers

Integrated belt clip

- For safe and comfortable carrying of the device on the body

Transparent backplate

- A visual inspection of the equipment is possible at all times
- The expiration date of the filter is easy to find

Info label on the inside

- Protected against abrasion
- Info at a glance: easily understood pictograms for the correct and quick donning of the equipment during a hazard

TPE sealing strap

- Easy to open and close: replace filters quickly and easily

Slip-proof holding areas

- Rough surfaces for safe use – also with work gloves

Service life

- Service life of 12 years provided the filter is exchanged after 6 years, and operated in accordance with the intended use

Robust, housing

- Mouthpiece and filter are vacuum sealed in a robust foil bag and are additionally protected by a housing.
- Suitable for daily use in rough work environments



D-28605-2015

MASKS & FILTERS

PRODUCT	DESCRIPTION	PART NO	PACKAGING UNIT/TYPE	CATEGORY
---------	-------------	---------	---------------------	----------

PARAT FILTER ESCAPE DEVICES

PARAT 3160 & 3260

The Parat 3160 is a filtering escape half mask and Parat 3260 is a filtering escape mouthpiece and nose-clip that protects users against toxic industrial gases, vapours and particles. These are ideal for users who want the lowest profile filtering escape devices. Tested according to EN & DIN standards to a minimum of 15 minutes of protection against gases that are filtered by an ABEK P3 filter. 12 Year service life with 1 filter change required after 6 years. Single use only and then half mask / mouthpiece & noseclip must be replaced.



1. PARAT 3160	Half mask & filter contained in a sealed foil bag in a belt worn case	R62630	1 / box	A
1. PARAT 3160 with Goggles	Gas tight goggles Included inside case	R62630	1 / box	A
2. PARAT 3260	Mouthpiece/nose-clip & filter contained in a sealed foil bag in a belt worn case	R62631	1 / box	A
3. PARAT 3160 blue training cover	To put on a standard Parat to identify it as a training unit only	R56353	1 / box	A
4. PARAT 3260 blue training cover		R56354	1 / box	A
PARAT 3160 replacement filter kit	Includes filter & half mask set	R62626	1 / box	A
PARAT 3260 replacement filter kit	Includes filter & mouthpiece/noseclip set	R62627	1 / box	A
PARAT 3160 and 3260 Sealing Strap	Optional to seal the Parat after replacing the filter	R56319	5 / box	H
PARAT 3160 and 3260 security tags	Required to seal the Parat after replacing the filter. Box Includes 50 tags	R56355	1 / box	H

Dräger PARAT® 4700 Filtering Escape Hoods

The Dräger PARAT® 4700 industrial escape hood was developed with users, placing the focus on the fastest possible escape. Optimized operation and wearing comfort, a robust housing and a tested ABEK P3 filter ensure protection from toxic industrial gases, vapours and particles for at least 15 minutes.

Clearly visible hood

Hood in signal colour for high visibility

Internal head harness

Thanks to the automatically adjusting internal head harness, no additional tightening of the hood is required.

High-performance filter

Filter expiration date is clearly marked; the filter is automatically released from the packaging when opened.

Exhalation valve

Directly leads the exhaled air out of the half mask

Overall protection

16 years of total service life (provided the filter is exchanged after 8 years), Hood provides respiratory and eye protection

Clear view

Wide field of vision due to a specially formed visor. Always a clear view thanks to a special anti-fog coating

Good fit

Specially designed half mask fits a wide variety of face sizes

Textile neck seal

Flexible textile neck seal

Place You Put Your Faith



Dräger PARAT® 5500 Filtering Escape Hoods

The Dräger PARAT® 5500 fire escape hood was developed in cooperation with users – always with the focus on offering the fastest possible escape. Optimized operation and wearing comfort, a robust housing and a tested CO P2 filter ensure protection from toxic fire-related gases, vapours and particles for at least 15 minutes while escaping.

Clearly visible hood

Hood in signal colour for high visibility

Internal head harness

Thanks to the automatically adjusting internal head harness, no additional tightening of the hood is required

High-performance filter

Filter expiration date is clearly marked; the filter is automatically released from the packaging when opened

Exhalation valve

Directly leads the exhaled air out of the half mask

Overall protection

16 years of total service life (provided the filter is exchanged after 8 years)*, Hood provides respiratory and eye protection

Clear view

Wide field of vision due to a specially formed visor. Always a clear view thanks to a special anti-fog coating

Good fit

Specially designed half mask fits a wide variety of face sizes

Textile neck seal

Flexible textile neck seal

*Exception PARAT 5550

Dräger PARAT® 7500 Filtering Escape Hoods

The combined fire and industrial escape hood Dräger PARAT® 7500 was developed with users, placing the focus on the fastest possible escape. Optimized operation and wearing comfort, a robust housing and a tested ABEK CO P3 filter ensure protection from toxic industrial and fire-related gases, vapours and particles for at least 15 minutes.

Clearly visible hood
Hood in signal colour for high visibility

Internal head harness
Thanks to the automatically adjusting internal head harness, no additional tightening of the hood is required.

High-performance filter
Filter expiration date is clearly marked; the filter is automatically released from the packaging when opened.

Exhalation valve
Directly leads the exhaled air out of the half mask

Overall protection
16 years of total service life (provided the filter is exchanged after 8 years), Hood provides respiratory and eye protection

Clear view
Wide field of vision due to a specially formed visor. Always a clear view thanks to a special anti-fog coating

Good fit
Specially designed half mask fits a wide variety of face sizes

Textile neck seal
Flexible textile neck seal

Place You Put Your Faith

MASKS & FILTERS

PRODUCT	DESCRIPTION	PART NO	PACKAGING UNIT/TYPE	CATEGORY
---------	-------------	---------	---------------------	----------

PARAT FILTER ESCAPE DEVICES

PARAT 4700

The Parat 4700 series is a filtering escape hood that protects users against toxic industrial gases, vapours and particles. Tested according to EN & DIN standards to a minimum of 15 minutes of protection. 16 Year service life with 1 filter change required after 8 years. Single use only and then hood must be replaced.



1. PARAT 4720	Soft Pack. IP5	R59421	1 / box	A
2. PARAT 4730	Hard Case. IP54	R59431	1 / box	A
PARAT 4720 and 4730 Replacement Filter Kit	ABEK P3 filter, replacement filter and security seal	R59471	1 / box	A
PARAT 4500 Spare Parts Kit	ABEK P3 Replacement filter and exhalation valve for PARAT 4500	R57978	1 / box	A

PARAT 5500

The Parat 5500 series is a filtering escape hood that protects users from smoke and other toxic gases and particles resulting from a fire. Tested according to EN & DIN standards to a minimum of 15 minutes of protection. 16 Year service life with 1 filter change required after 8 years. Single use only and then hood must be replaced.

3. PARAT 5510	Single carton pack	R59415	1 / box	A
4. PARAT 5520	Soft Pack. IP5	R59425	1 / box	A
5. PARAT 5530	Hard Case. IP54	R59435	1 / box	A
PARAT 5510 Replacement Filter Kit	CO P3 replacement filter and label	R59474	1 / box	A
PARAT 5520 and 5530 Replacement Filter Kit	CO P3 replacement filter and security seal	R59475	1 / box	A
PARAT C Spare Replacement Filter Kit	CO P3 replacement filter and exhalation valve	R57302	1 / box	A

PARAT 7500

The Parat 7500 series combines the Parat 4700 & 5500 series into a single filtering escape hood to protect users from both smoke and many chemicals found on industrial sites. Tested according to EN & DIN standards to a minimum of 15 minutes of protection. 16 Year service life with 1 filter change required after 8 years. Single use only and then hood must be replaced.

4. PARAT 7520	Soft Case	R59427	1 / box	A
5. PARAT 7530	Hard Case	R59437	1 / box	A
PARAT 7500 Replacement Filter Kit	ABEK CO P3 replacement filter and security seal	R59477	1 / box	A

MASKS & FILTERS

PRODUCT	DESCRIPTION	PART NO	PACKAGING UNIT/TYPE	CATEGORY
---------	-------------	---------	---------------------	----------

PARAT FILTER ESCAPE DEVICES

PARAT 4,5,7000 Training Hoods



1. PARAT 4,5,7000 Training Hood	Soft Pack. IP5	R59420	1 / box	A
2. PARAT 4,5,7000 Training Hood	Hard Case. IP54	R59430	1 / box	A
3. PARAT 4,5,7000 Training Hood	Single Pack Box	R59410	1 / box	A
PARAT 4,5,7000 Training Hood Spare Parts				
PARAT Training Hood Filter Plugs	20x Filter Plug Straps	R59482	1 / box	A
PARAT Training Hood Security Seals	10x White Security Seals	R59484	1 / box	A
PARAT Training Hood Filters	1x Replacement Filter	R59479	1 / box	A

Place You Put Your Faith

MASKS & FILTERS

PRODUCT	DESCRIPTION	PART NO	PACKAGING UNIT/TYPE	CATEGORY
---------	-------------	---------	---------------------	----------

PARAT FILTER ESCAPE DEVICES

PARAT 4,5, 7000 Carrying & Mounting Accessories

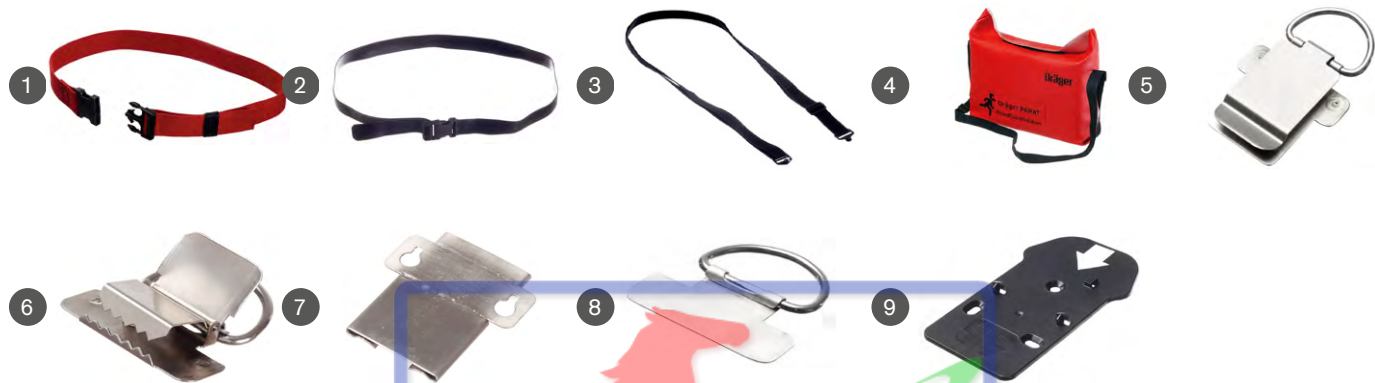

1. PARAT Waist Belt - Textile	Robust and comfortable	6733934	1 / box	D
2. PARAT Waist Belt - Plastic	Easy to clean	R53026	1 / box	A
3. PARAT Shoulder Strap	Perfect for short-term and recurring operations, fast to don and remove	R59461	1 / box	A
4. Carry Bag for Parat 5510	Red bag with shoulder harness for carrying / storing 2 PARAT 5510 Single Packs	R51907	1 / box	A
5. PARAT Grip Clip	Slips over belt & D-Ring	R59456	1 / box	A
6. PARAT Grip Clip	Crocodile attachment & D-Ring	R59455	1 / box	A
7. PARAT Adaptor Plate (Soft Pack)	Adaptor plate is needed to use the belt or grip clip with the soft pack	R58742	1 / box	A
8. PARAT D Ring	For use with a Carabiner	R59457	1 / box	A
9. PARAT Wall Holder (Hard Case)	Wall holder bracket for hard case only	R59451	1 / box	A

Dräger PARAT® 5550 Escape hoods

The Dräger PARAT® 5550 is a fire escape hood packaged in a flame retardant holster. It was specifically developed for fire rescue teams for use in victim rescue. The main advantage: The PARAT® 5550 is system approved together with Dräger breathing apparatus according to EN 137:2006, Type 2.

Multiple carrying options
using the shoulder strap, carabiner hook or the integrated belt loop

Easy-to-open
even when wearing gloves, due to the perforated foil pouch

**Flame-retardant
Aramid material**
assures quality according to
DIN EN 137:2006, Type 2

Transparent foil pouch
allows instant
visual inspection
and at the same
time protects
against dirt, dust
and water splashes



Optional accessory pockets
for additional equipment
like wedges or loops

Filter plug
reliably protects the filter throughout
the 8 year filter life

Donning instructions
are clearly visible at all times

MASKS & FILTERS

PRODUCT	DESCRIPTION	PART NO	PACKAGING UNIT/TYPE	CATEGORY
---------	-------------	---------	---------------------	----------

PARAT FILTER ESCAPE DEVICES

PARAT 5550

The Parat 5550 is a unique variant of the Parat 5500 which is designed for fire services to rescue people at risk of smoke inhalation. Tested according to EN & DIN standards to a minimum of 15 minutes of protection. 16 Year service life with 1 filter change required after 8 years.



1. PARAT 5550	Fire retardant soft pack	R59445	1 / box	A
2. Accessory Pocket, large	optional attachable pocket to carry additional accessories like loops, can be mounted on the front of the holster	R59491	1 / box	A
3. Accessory Pocket, small	optional attachable pocket to carry additional accessories like wedges, can be mounted on either side of the holster	R59492	1 / box	A
4. Replacement Soft Pack	Flame retardant soft pack excluding fire escape hood and accessory pockets	R59490	1 / box	A
Spare Part Kit, Breakable Loops	If the emergency release is activated by breaking the yellow loop, it can be replaced with this set containing a yellow breakable loop attached on a velcro belt holder.	R59493	10 / box	A
5. Shoulder Harness	Flame retardant shoulder strap especially for use with the PARAT 5550 Holster	R59462	1 / box	A
6. Refill Pack	Fire escape hood enclosed in a perforated foil pouch	R59476	1 / box	A
7. Carabiner Hook 65x6,5 mm	Can be used to attach the holster on a back-plate of the BA set	R55573	10 / box	A

MASKS & FILTERS

PRODUCT	DESCRIPTION	PART NO	PACKAGING UNIT/TYPE	CATEGORY
---------	-------------	---------	---------------------	----------

FIT TESTING

Qualitative fit test kit - Bitrex



1. Qualitative fit test kit Bitrex	Kit Includes hood, 2 nebulizers, 6 ampoules fit test solution, 6 ampoules sensitivity solution and instructions. Estimate 3 to 5 fit tests per ampule. Can be used to fit test any mask with a filter of at least P1 rating or higher.	4055625	1	D
Spare Bitrex fit test solution	Includes 6 ampoules. Estimate 3 to 5 fit tests per ampoule.	4055624	1	D
Spare Bitrex sensitivity solution	Includes 6 ampoules	4055623	1	D
Fit test hood	Only for Bitrex fit test kit.	4055650	1	D
Nebulizer	Only for Bitrex fit test kit.	4055646	1	D

Qualitative fit test kit - Irritant Smoke

2. Irritant smoke qualitative fit test kit	Kit Includes squeeze bulb, 6 smoke tubes and instructions. A hood should not be worn when performing this type of test. Estimate 6 to 8 fit tests per tube. Can be used to fit test any mask with a P3 filter.	4053844	1	D
--	--	---------	---	---

FIRE & GAS DETECTION SYSTEMS

POINT TOXIC GAS DETECTORS

Polytron 5100 Transmitter & Accessories	292
Polytron 8000 Transmitter & Accessories	294
Polytron 7000 Transmitter, Sensors & Accessories	298
Polytron 3000 Transmitter, Sensors & Accessories	301
PIR 7200 Transmitter & Accessories	306
Polytron 5720 Transmitter & Accessories	308
Polytron 8720 Transmitter & Accessories	310
Polytron 8900 Transmitter & Accessories	312

POINT EXPLOSIVE / FLAMMABLE GAS DETECTORS

PIR 7000 Transmitter & Accessories	313
Polytron 5700 Transmitter & Accessories	314
Polytron 8700 Transmitter & Accessories	315
PIR 3000 Transmitter & Accessories	319
Polytron 5310 Transmitter & Accessories	320
Polytron 8310 Transmitter & Accessories	321
Polytron SE Ex Transmitter & Accessories	322
PEX 3000 Transmitter, Sensors & Accessories	324
Polytron 5200 Transmitter & Accessories	326
Polytron 8200 Transmitter & Accessories	328
Spare Catalytic Sensors	330

CONTROL SYSTEMS

REGARD 7000	331
REGARD 2400 / 2410	333
REGARD 3900	334
Regard 1	335

SAFE AREA DETECTOR & CONTROLLER

VarioGard Central Unit	336
VarioGard 3000	337
VarioGard 2400	337
Polytron 2000	338
PEX 1000	339
PointGard 2200	340

OPEN PATH FLAMMABLE GAS DETECTORS

Polytron Pulsar 7000	341
Accessories	342

OPEN PATH TOXIC GAS DETECTORS

Quasar 960	344
------------	-----

FLAME DETECTORS

Flame 3000 Visual Flame Detector	345
Flame 5000 Visual Flame Detector	347
Dräger Flame 2x0	349
IR Flame detector 40/40R	353

3RD PARTY EQUIPMENT

Gas Sampling Systems SAM 3100/3200	358
------------------------------------	-----

GASSECURE

GasSecure GS01 & Accessories	361
------------------------------	-----

ACCESSORIES

Calibration Accessories	362
General Accessories	363
Selective Filters	365
Polytron 5000/8000 Spare Parts & Accessories	365

ABBREVIATIONS

Abbreviations	367
---------------	-----

FIRE & GAS DETECTION SYSTEMS

TRANSMITTER FEATURES

DETECTORS

FEATURES	Polytron 2 Xp Ex	Polytron Fx	Polytron 5200	Polytron 8200	Polytron 5200 LC	Polytron 8200 LC	Polytron Tx	Polytron 5000	Polytron 2 Xp Tox	Polytron 3000	Polytron 7000	Polytron 7500	Polytron 5100	Polytron 8000 (8100)	Polytron 2 Xp Ex IR	Polytron 5310	Polytron 8310	PIR 3000	PIR 7000	Polytron 5700	Polytron 8700	PIR 7200	Polytron 5720	Polytron 8720
Gases Detected	F	F	F	F	F	F	T/O	T/O	T/O	T/O	T/O	T	T/O	T/O	F	F	F	F	F	F	F	CO2	CO2	CO2
Sensor - Electro Chemical	-	-	-	-	-	-	X	X	X	X	X	X	X	X	-	-	-	-	-	-	-	-	-	-
Sensor - Catalytic	X	X	X	X	X	X	-	-	-	-	-	-	-	-	-	-	-	-	-	-	-	-	-	-
Sensor - Infra red	-	-	-	-	-	-	-	-	-	-	-	-	-	-	X	X	X	X	X	X	X	X	X	X
Remote Sensor Option	-	-	X	X	X	X	-	-	-	X	X	-	X	X	-	X	X	-	-	X	X	-	X	X
Display	X	X	X	X	X	X	X	X	X	X	X	X	X	X	X	X	X	-	-	X	X	-	X	X
4 TO 20 mA output	X	X	X	X	X	X	X	X	X	X	X	X	X	X	X	X	X	X	X	X	X	X	X	X
Relays	O	-	O	O	O	O	-	-	O	-	O	O	O	O	O	O	O	-	-	O	O	-	O	O
HART	X	-	-	X	-	X	-	-	X	-	O	-	-	X	X	-	X	-	X	-	X	X	-	X
Flame-proof - Ex d	X	X	X	X	X	X	X	X	X	-	-	-	X	X	X	X	X	X	X	X	X	X	X	X
Intrinsically Safe - Ex ia	-	-	-	-	-	-	-	-	-	X	X	-	-	-	-	-	-	-	-	-	-	-	-	-
Approvals - IEC Ex	-	-	X	X	X	X	-	X	-	X	X	-	X	X	-	X	X	X	X	X	X	X	X	X
Approvals - ATEX	X	X	X	X	X	X	X	X	X	X	X	-	X	X	X	X	X	X	X	X	X	X	X	X
SIL 2	-	-	X	-	-	-	-	-	-	-	X	-	-	X	-	-	X	-	X	X	X	-	X	X
Low End Models	-	X	X	X	X	X	X	X	X	-	-	-	-	-	-	-	-	-	-	-	-	-	-	-
Mid End Models	-	-	-	-	-	-	-	-	-	-	-	-	X	-	X	x	X	x	-	-	-	-	-	-
High End Models	X	-	-	X	-	X	-	-	X	-	X	X	-	X	-	-	-	-	X	X	X	X	X	X
Hazardous Areas 0,1 & 2	-	-	-	-	-	-	-	-	-	X	X	-	-	-	-	-	-	-	-	-	-	-	-	-
Hazardous Areas 1 & 2	X	X	X	X	X	X	X	X	X	X	X	-	X	X	X	X	X	X	X	X	X	X	X	X
Safe Area Only	-	-	-	-	-	-	-	-	-	-	-	x	-	-	-	-	-	-	-	-	-	-	-	-
Diagnostic Dongle (EC Sensor)	-	-	-	-	-	-	-	-	-	-	x	x	-	x	-	-	-	-	-	-	-	-	-	-
Calibration Config Tool	D	M	M	M	M	M	M	M	D	D	D	D	M	M	D	M	M	M	M	M	M	M	M	M
	Obsolete - Replace with Polytron 8200	Obsolete - Replace with Polytron 5200			0 - 10% LEL only	0 - 10% LEL only	Obsolete - Replace with Polytron 5100	Obsolete - Replace with Polytron 5100	Obsolete - Replace with Polytron 8000 (8100)			Obsolete - No Replacement			Obsolete - Replace with Polytron 8310									

Abbreviations

F: Flammable T: Toxic O: Oxygen CO2: Carbon Dioxide Optional Relays O: Optional X: Standard D: Display M: Magnet

FIRE & GAS DETECTION SYSTEMS

SENSOR - TRANSMITTER CHART

NAME	PART NR.	RANGE	Polytron 1 Obsolete Replace with Polytron 3000	Polytron 2, Obsolete Obsolete Replace with Polytron 7000	Polytron 3000	Polytron 7000 Polytron 8000 *	Polytron 5100	Polytron 5000 Obsolete Replace with Polytron 5100	Polytron Tx Obsolete Replace with Polytron 5100	Polytron 2 Xp Tox Obsolete Replace with Polytron 8000	Pyrolizer (Obsolete) * Polytron 7500	Polytron L Obsolete Replace with Polytron 7000/8000 with C12/Acid Sensor	Product Group
Acid (AC)	6810595	0 - 30 ppm		X	X	X				X			H
CL2	6809665	0 - 50 ppm	X	X	X	X	X	X	X	X			H
CO	6809605	0 - 1000 ppm	X	X	X	X	X	X	X	X			H
CO LS	6809620	0 - 5000 ppm	X	X	X	X				X			H
CO LH	6812570	0 - 300 ppm				X				X			H
COCl2	6809930	0 - 20 ppm		X		X				X			H
H2	6809685	0 - 3000 ppm	X	X	X	X	X			X			H
H2O2 HC	6809675	0 - 7000 ppm		X		X				X			H
H2O2 LC	6809705	0 - 50 ppm		X		X	X	X		X			H
H2S	6810435	0 - 100 ppm		X	X	X	X	X		X			H
H2S HC	6809710	0 - 1000 ppm	X	X		X	X	X		X			H
H2S LS	6809610	0 - 100 ppm	X	X		X	X	X	X	X			H
HCL	6809640	0 - 100 ppm		X		X				X			H
HCN	6809650	0 - 50 ppm	X	X		X				X			H
HCN - LC	6813200	0 - 50 ppm				X				X			H
Hydrazine	6810180	0 - 5 ppm		X	X	X				X			H
Hydride	6809635	0 - 20 ppm		X	X	X				X			H
Hydride-SC	6809980	0 - 1 ppm		X	X	X				X			H
NH3 HC	6809645	0 - 1000 ppm	X	X	X	X	X	X		X			H
NH3 LC	6809680	0 - 200 ppm	X	X	X	X	X	X	X	X			H
NH3 TL	6813095	0 - 300 ppm				X	X						H
NH3 FL	6813260	0 - 300 ppm				X	X						H
NO	6809625	0 - 200 ppm	X	X	X	X	X	X		X			H
NO2	6809655	0 - 100 ppm	X	X	X	X	X	X	X	X			H
NO2 - LC	6813205	0 - 20 ppm				X							H
O2	6809720	0 - 100 vol. %	X	X	X	X				X			H
O2 LS	6809630	0 - 25 vol. %	X	X	X	X	X	X	X	X			H
OV	6809615	0 - 50 ppm	X	X	X					X			H
OV 1	6810740	0 - 300 ppm	X	X	X	X	X	X		X			H
OV 2	6810745	0 - 100 ppm		X		X				X			H
Ozone	6810290	0 - 5 ppm		X	X	X				X			H
PH3/AsH3	6809695	0 - 20 ppm		X		X	X			X			H
SO2	6809660	0 - 100 ppm	X	X	X	X	X	X	X	X			H
CL2 - L	6809370	0 - 50 ppm										X	H
HF/HCL/BF3	6809360	0 - 20 ppm										X	H
NF3	6809310	0 - 50 ppm									X		H
NF3	6811125	0 - 50 ppm									X		H
PFC	6811120	2 - 30 ppm									X		H
C5F8	6810500	0 - 1000 ppm									X		H

FIRE & GAS DETECTION SYSTEMS

PRODUCT	PART NO	PACKAGING UNIT	CATEGORY
---------	---------	----------------	----------



Transmitter with Electro-chemical Sensors for the detection of Oxygen, Toxic gases & vapours.

Output: 4 - 20 mA

Explosion Proof (Flame Proof) Ex d

2-wire, input: 18 to 30 VDC (Non Relay operation / No Backlight)

3-wire, input: 10 to 30 VDC (Relay/Back-light)

Requires Transmitter + Electro-Chemical Sensor

Remote Sensor Option requires - EC Sensing head w/bracket + Cable

Options - Relays (2 x Alarm Relays / 1 x Fault)

Cable entry thread is 3/4" NPT

Polytron 5100 (IEC Ex Approved)			
Polytron 5100 d A 4-20mA	8344860	1	G
Polytron 5100 d A 4-20mA/Relays	8344121	1	G
Polytron 5100 d S 4-20mA	8344862	1	G
Polytron 5100 d S 4-20mA/ Relays	8344500	1	G
Dräger Polytron 5100 EC e A*	8344124		
Dräger Polytron 5100 EC e A relay*	8344121		
Remote sensor option for Polytron 5100 EC Sensors. Remote Sensor Option requires - EC Sensing head w/bracket + Cable			
EC sensing head remote with mounting bracket	6812684	1	G
Cable and plug, 16 ft (5 m)	8323305	1	G
Cable and plug, 49 ft (15 m)	8323315	1	G
Cable and plug, 98 ft (30 m)	8323330	1	G
Sensors			
DrägerSensor Acidic Compounds AC	6810595	1	
DrägerSensor Cl ₂	6809665	1	
DrägerSensor CO	6809605	1	
DrägerSensor CO LS	6809620	1	
DrägerSensor CO LH	6812570	1	
DrägerSensor COCl ₂	6809930	1	
DrägerSensor H ₂	6809685	1	
DrägerSensor H ₂ O ₂ LC	6809705	1	
DrägerSensor H ₂ S	6810435	1	
DrägerSensor H ₂ S HC	6809710	1	
DrägerSensor H ₂ S LC	6809610	1	
DrägerSensor HCN LC	6813200	1	

FIRE & GAS DETECTION SYSTEMS

PRODUCT	PART NO	PACKAGING UNIT	CATEGORY
DrägerSensor Hydride	6809635	1	
DrägerSensor N ₂ H ₄	6810180	1	
DrägerSensor NH ₃ HC	6809645	1	
DrägerSensor NH ₃ LC	6809680	1	
DrägerSensor NH ₃ TL	6813095	1	
DrägerSensor NO	6809625	1	
DrägerSensor NO ₂	6809655	1	
DrägerSensor NO ₂ LC	6813205	1	
DrägerSensor O ₂	6809720	1	
DrägerSensor O ₂ LS	6809630	1	
DrägerSensor OV 1	6810740	1	
DrägerSensor OV 2	6810745	1	
DrägerSensor SO ₂	6809660	1	
Accessories			
Magnet With Key Chain,P5000/8000	4544101	1	G
IRDA Interface Assembly	4544197	1	G
Splash Guard	6812510	1	G
Remote calibration adapter Polytron 8000, 5100/7000, 8000	6807955	1	G
Process Adapter RS EC Stainless Steel (e.g. Pharma industry)	8323404	1	G
Pipe Mount Kit	4544198	1	G
Duct Mount Kit	6812725	1	G
Duct Mount Adapter for Remote EC sensing head	8317617	1	G
Calibration Adapter Viton	6810536	1	G
Gassing Adapter	6806978	1	G
Docking Station/ E-Box Polytron 5xx0/8xx0 Power	8344027	1	
Docking Station/ E-Box Polytron 5xx0/8xx0 for relay/remote	8344028	1	

FIRE & GAS DETECTION SYSTEMS

PRODUCT	PART NO	PACKAGING UNIT	CATEGORY
---------	---------	----------------	----------

The Polytron 8100 EC is Dräger's top of the line explosion proof transmitter for the detection of toxic gases or oxygen. It uses a high performance plug and play electrochemical DrägerSensor to detect a specific gas. It comes standard with an analog 3 wire 4-20mA HART output. Relays and fieldbus interface module are optional. You can choose between explosion proof "d" (USA) or flame proof increased safety "e" version (Europe) and aluminum (A) or stainless steel (S).

*The docking station (E-Box) is included with every "e" version. A configurable part number 8344800 is available for some stainless steel and all fieldbus options. Please calculate the total price by adding the options below to the base price.



Universal transmitter for all electrochemical Dräger Sensors for detection of oxygen & Toxic gases. Can be installed as stand alone device with built in Relays. Diagnostic menu similar to Polytron 2/Polytron 7000. Only fixed gas detector with option of built in relay with Explosion protection (Ex d).

Sensor connection is Intrinsically Safe.

Output: 4 - 20 mA, HART, RS 485

Self-diagnostics of transmitter and Sensor

Explosion Proof (Flame Proof) Ex d

3-wire, input: 10 to 32 VDC

optional Relays output: A1, A2, Fault

Remote sensor using remote sensor housing

Dongles: Diagnostic, Data, Sensor test and combination

Requires Transmitter + Sensor

E Version Transmitter requires E-Box (power only or power/relay)

optional Relays with alarm outputs: A1, A2, Fault

Remote Sensor Option requires - EC Sensing head w/bracket + Cable

Cable entry thread is 3/4" NPT

Place Your Faith

DRÄGER Polytron 8000 Ex d (Approval IEC Ex, ATEX, UL, CSA) with HART, SIL 2 (IEC61508)			
Ex d Versions			
Polytron 8100 d A 4-20/HART	8344403	1	G
Polytron 8100 d A 4-20/HART relay	8344404	1	G
Polytron 8100 d S 4-20/HART	8344412	1	G
Polytron 8100 d S 4-20/HART relay	8344413	1	G
Ex e Versions (require appropriate E-Box for complete set) /(For remote sensing, add remote option)			
Polytron 8100 e A 4-20/HART	8344421	1	G
Polytron 8100 e A 4-20/HART relay	8344422	1	G

FIRE & GAS DETECTION SYSTEMS

PRODUCT	PART NO	PACKAGING UNIT	CATEGORY
Some Steel variants need to be configured using Polytron configurator online, and must accompany all order. Part number 8344800 is a common configurable part number.			
Polytron 8100 e S 4-20/HART	8344800	1	G
Polytron 8100 e S 4-20/HART relay	8344800	1	G
E-Box Power only version Docking Station	6812420	1	G
E-Box Power/Relay/Remote version Docking Station	6812275	1	G
Remote sensor option for Polytron 8000 EC Sensors. Remote Sensor Option requires - EC Sensing head w/bracket + Cable			
EC sensing head remote with mounting bracket	6812684	1	G
Cable and plug, 16 ft (5 m)	8323305	1	G
Cable and plug, 49 ft (15 m)	8323315	1	G
Cable and plug, 98 ft (30 m)	8323330	1	G
Accessories			
Magnet With Key Chain,P5000/8000	4544101	1	G
IRDA Interface Assembly	4544197	1	G
Pipe Mount Kit	4544198	1	G
Duct Mount Kit	6812725	1	G
Duct Mount Adapter for Remote EC Sensing Head	8317617	1	G
Process Adapter RS EC Stainless Steel (e.g. Pharma industry)	8323404	1	G
Splash Guard	6812510	1	G
Calibration Adapter Viton	6810536	1	G
Gassing Adapter	6806978	1	G
Remote calibration adapter-Polytron 3000, 5100/7000, 8000	6807955	1	G
Dongles			
Sensor Diagnostics Dongle	8317860	1	G
Sensor Test Dongle	8317619	1	G

FIRE & GAS DETECTION SYSTEMS

PRODUCT	PART NO	PACKAGING UNIT	CATEGORY
---------	---------	----------------	----------



LS: Long Term Stable
 LH: Hydrogen Compensation (only for CO)
 LC: Low Concentration
 LH: High Concentration
 SC: Semi-conductor Industry

Ranges of Sensors detecting multiple gases may vary for various gases. Please check individual IFU for information.

Electro Chemical Sensors			
Dräger Sensor AC (Range: 0 - 30 PPM)	6810595	1	G
Dräger Sensor Cl ₂ (Range: 0 - 50 PPM)	6809665	1	G
Dräger Sensor CO (Range: 0 - 1000 PPM)	6809605	1	G
Dräger Sensor CO LS (Range: 0 - 5000 PPM)	6809620	1	G
Dräger Sensor CO LH (Range: 0 - 300 PPM)	6812570	1	G
Dräger Sensor Phosgene - COCl ₂ (Range: 0 - 20 PPM)	6809930	1	G
Dräger Sensor H ₂ (Range: 0 - 3000 PPM)	6809685	1	G
Dräger Sensor H ₂ O ₂ HC (Range: 0 - 7000 PPM)	6809675	1	G
Dräger Sensor H ₂ O ₂ LC (Range: 0 - 50 PPM)	6809705	1	G
Dräger Sensor H ₂ S (Range: 0 - 100 PPM)	6810435	1	G
Dräger Sensor H ₂ S HC (Range: 1000 PPM)	6809710	1	G
Dräger Sensor H ₂ S LC (Range: 0 - 100 PPM)	6809610	1	G
Dräger Sensor HCl (Range: 0 - 100 PPM)	6809640	1	G
Dräger Sensor HCN (Range: 0 - 50 PPM)	6809650	1	G
Dräger Sensor HCN LC (Range: 0 - 50 PPM)	6813200	1	G
Dräger Sensor Phosphine - PH ₃ (Range: 0 - 20 PPM)	6809695	1	G
Dräger Sensor Hydride (Range: 0 - 20 PPM)	6809635	1	G
Dräger Sensor Hydride SC (Range: 0 - 1 PPM)	6809980	1	G
Dräger Sensor Hydrazine - N ₂ H ₄ (Range: 0 - 5 PPM)	6810180	1	G
Dräger Sensor NH ₃ HC (Range: 0 - 1000 PPM)	6809645	1	G
Dräger Sensor NH ₃ LC (Range: 0 - 100 PPM)	6809680	1	G
Dräger Sensor NH ₃ TL (Range: 0 - 300 PPM)	6813095	1	G

Dräger Region South East Europe | Rev: 0 | Subject to modification! | www.draeger.com

FIRE & GAS DETECTION SYSTEMS

PRODUCT	PART NO	PACKAGING UNIT	CATEGORY
Dräger Sensor NH3 FL (Range: 0 - 300 PPM)	6813260	1	G
Dräger Sensor NO LC (Range: 0 - 200 PPM)	6809625	1	G
Dräger Sensor NO2 (Range: 0 - 100 PPM)	6809655	1	G
Dräger Sensor NO2 LC (Range: 0 - 20 PPM)	6813205	1	G
Dräger Sensor O2 (Range: 0 - 100 Vol. %)	6809720	1	G
Dräger Sensor O2 LS (Range: 0 - 25 Vol. %)	6809630	1	G
Dräger Sensor Ozone -O3 (Range: 0 - 5 PPM)	6810290	1	G
Dräger Sensor OV1 (Range: 0 - 300 PPM)	6810740	1	G
Dräger Sensor OV2 (Range: 0 - 100 PPM)	6810745	1	G
Dräger Sensor SO2 (Range: 0 - 100 PPM)	6809660	1	G



Place You Put Your Faith

FIRE & GAS DETECTION SYSTEMS

PRODUCT	PART NO	PACKAGING UNIT	CATEGORY
---------	---------	----------------	----------

TOXIC GAS DETECTORS



Universal Intrinsically safe Transmitter with Display for detection of Toxic gases & Oxygen. Diagnostic menu & features for predictive maintenance and safety functions (SIL2 Verified if Included with Diagnostic Dongle). Option of duct mounting kit, Pipe mounting Kit, remote sensor and (non-Ex) Relay & pump.

Requires Polytron 7000 + Docking Station + Sensor

Polytron 7000 with Relays require Cable connector Part # 1890086.

Note: LON Bus Protocol available on request

Remote Sensor Option requires - Remote Sensor Adapter + Cable

POLYTRON 7000 (IEC Ex & ATEX Approved)			
Dräger Polytron 7000 Display 4 to 20 mA and Sensor diagnostic dongle	8317980	1	G
Docking Station (required for each transmitter)	8317990	1	G
Polytron 7000 Display 4-20mA	8317610	1	G
Polytron 7000 Display 4-20mA HART	8317710	1	G
Polytron 7000 Display PB, with Profibus Module	8319430	1	G
Polytron 7000 Display FB, with Foundation Fieldbus Module	8319440	1	G
Safety Barrier Zone 2	8323873	1	G
Polytron 7000 below with Pumps (For safe area installation only)			
Polytron 7000 Display 4-20mA with Pump	8317637	1	G
Polytron 7000 Display 4-20mA HART with Pump	8317777	1	G
Polytron 7000 Display PB, with Profibus Module with Pump	8319436	1	G
Polytron 7000 Display FB, with Foundation Fieldbus Module & Pump	8319437	1	G
Polytron 7000 below with Relays require cable connector - Part # 1890086 (For safe area installation only)			
Polytron 7000 Display 4-20mA with Relay	8317636	1	G
Polytron 7000 Display 4-20mA HART with Relay	8317776	1	G
Polytron 7000 Display PB, with Profibus Module with Relay	8319427	1	G
Polytron 7000 Display FB, with Foundation Fieldbus Module & Relay	8319428	1	G
Polytron 7000 below with Relays & Pump require cable connector - Part # 1890086 (For safe area installation only)			
Polytron 7000 Display 4-20mA with Relay & Pump	8317638	1	G
Polytron 7000 Display 4-20mA HART with Relay & Pump	8317778	1	G
Polytron 7000 Display PB, with Profibus Module with Relay & Pump	8319438	1	G
Polytron 7000 Display FB, with Foundation Fieldbus Module + Relay & Pump	8319439	1	G

FIRE & GAS DETECTION SYSTEMS

PRODUCT	PART NO	PACKAGING UNIT	CATEGORY
---------	---------	----------------	----------



LS: Long Term Stable
 LH: Hydrogen Compensation (only for CO)
 LC: Low Concentration
 LH: High Concentration
 SC: Semi-conductor Industry

Ranges of Sensors detecting multiple gases may vary for various gases. Please check individual datasheets for information.

Electro Chemical Sensors			
Dräger Sensor Acidic Compound AC (Range: 0 - 30 PPM)	6810595	1	G
Dräger Sensor Cl ₂ (Range: 0 - 50 PPM)	6809665	1	G
Dräger Sensor CO (Range: 0 - 1000 PPM)	6809605	1	G
Dräger Sensor CO LS (Range: 0 - 5000 PPM)	6809620	1	G
Dräger Sensor CO LH (Range: 0 - 300 PPM)	6812570	1	G
Dräger Sensor Phosgene - COCl ₂ (Range: 0 - 20 PPM)	6809930	1	G
Dräger Sensor H ₂ (Range: 0 - 3000 PPM)	6809685	1	G
Dräger Sensor H ₂ O ₂ HC (Range: 0 - 7000 PPM)	6809675	1	G
Dräger Sensor H ₂ O ₂ LC (Range: 0 - 50 PPM)	6809705	1	G
Dräger Sensor H ₂ S (Range: 0 - 100 PPM)	6810435	1	G
Dräger Sensor H ₂ S HC (Range: 1000 PPM)	6809710	1	G
Dräger Sensor H ₂ S LC (Range: 0 - 100 PPM)	6809610	1	G
Dräger Sensor HCl (Range: 0 - 100 PPM)	6809640	1	G
Dräger Sensor HCN (Range: 0 - 50 PPM)	6809650	1	G
Dräger Sensor HCN LC (Range: 0 - 50 PPM)	6813200	1	G
Dräger Sensor Phosphine - PH ₃ /AsH ₃ (Range: 0 - 20 PPM)	6809695	1	G
Dräger Sensor Hydride (Range: 0 - 20 PPM)	6809635	1	G
Dräger Sensor Hydride SC (Range: 0 - 1 PPM)	6809980	1	G
Dräger Sensor Hydrazine - N ₂ H ₄ (Range: 0 - 5 PPM)	6810180	1	G
Dräger Sensor NH ₃ HC (Range: 0 - 1000 PPM)	6809645	1	G
Dräger Sensor NH ₃ LC (Range: 0 - 100 PPM)	6809680	1	G
Dräger Sensor NH ₃ TL (Range: 0 - 300 PPM)	6813095	1	G
Dräger Sensor NO LC (Range: 0 - 200 PPM)	6809625	1	G
Dräger Sensor NO ₂ (Range: 0 - 100 PPM)	6809655	1	G
Dräger Sensor NO ₂ LC (Range: 0 - 20 PPM)	6813205	1	G
Dräger Sensor O ₂ (Range: 0 - 100 Vol. %)	6809720	1	G

FIRE & GAS DETECTION SYSTEMS

PRODUCT	PART NO	PACKAGING UNIT	CATEGORY
Dräger Sensor O2 LS (Range: 0 - 25 Vol. %)	6809630	1	G
Dräger Sensor Ozone -O3 (Range: 0 - 5 PPM)	6810290	1	G
Dräger Sensor OV1 (Range: 0 - 300 PPM)	6810740	1	G
Dräger Sensor OV2 (Range: 0 - 100 PPM)	6810745	1	G
Dräger Sensor SO2 (Range: 0 - 100 PPM)	6809660	1	G
Accessories			
Remote Sensor Adapter Polytron 7000 (requires adapter and cable)	8317275	1	G
Remote cable + plug 5 m Polytron 7000	8317270	1	G
Remote cable + plug 15 m Polytron 7000	8317998	1	G
Remote cable + plug 30 m Polytron 7000	8317999	1	G
Remote Duct adapter Polytron 7000	8317617	1	G
Duct Mount Kit Polytron 3000/7000	8317150	1	G
Cable Entry Set Polytron 7000	8317282	1	G
Cable Connector Relay Polytron 7000	1890086	1	G
Calibration-/process adapter 2 AC	8324093	1	G
Mounting Set P2IR/P3000/P7000	6809951	1	G
Splash Guard	6807549	1	G
USB DIRA with USB cable	8317409	1	
Calibration Adapter Viton	6810536	1	G
Gassing Adapter	6806978	1	G
Remote calibration adapter for Polytron 3000, 5100/7000, 8000	6807955	1	G
Calibration/Process adapter AC	6809380	1	G
Splash guard Acidic Compounds	6809379	1	G
Pump adapter,complete, Polytron 7000	8317885	1	G
Pump adapter AC Polytron 7000	8317976	1	G
Modules			
Internal Pump Polytron 7000	8317350	1	G
Relay Module Polytron 7000	8317360	1	G
Dongles			
Data Dongle Polytron 7000	8317618	1	G
Sensor Diagnostics Dongle Polytron 7000	8317860	1	G
Sensor Test Dongle Polytron 7000	8317619	1	G

FIRE & GAS DETECTION SYSTEMS

PRODUCT	PART NO	PACKAGING UNIT	CATEGORY
---------	---------	----------------	----------



The Dräger Polytron 3000 transmitter is an intrinsically safe gas detector for continuous monitoring of toxic gases and oxygen in ambient air. The compact housing consists of two parts: the "Polytron Docking Station" and the "Polytron 3000" device. This two component concept and quick lock mechanism provides greater flexibility and simplicity for installation. Designed for one-man calibration the Polytron 3000 can either accept a pre-calibrated sensor or the sensor can be calibrated with the unit.

Transmitter for Acidic Compounds			
Dräger Polytron 3000 AC 3 ppm	8316652	1	
Dräger Polytron 3000 AC 3 ppm Non Display	8316752	1	
Dräger Polytron 3000 AC 10 ppm	8316657		
Dräger Polytron 3000 AC 10 ppm Non Display	8316757		
Sensor for Acidic Compounds			
DrägerSensor Acidic Compounds AC	6810595	1	
Transmitter for Ammonia			
Dräger Polytron 3000 NH ₃ LC 100 ppm	8316637	1	
Dräger Polytron 3000 NH ₃ LC 100 ppm Non Display	8316737	1	
Dräger Polytron 3000 NH ₃ HC 300 ppm	8316638	1	
Dräger Polytron 3000 NH ₃ 3 HC 300 ppm Non Display	8316738	1	
Dräger Polytron 3000 NH ₃ HC 1000 ppm	8316639	1	
Dräger Polytron 3000 NH ₃ HC 1000 ppm Non Display	8316739	1	
Sensors for Ammonia			
DrägerSensor NH ₃ LC	6809680	1	
DrägerSensor NH ₃ HC	6809645	1	
Transmitter for Boron Trichloride			
Dräger Polytron 3000 BCl ₃ 10 ppm	8316666	1	
Dräger Polytron 3000 BCl ₃ 10 ppm Non Display	8316766	1	
Sensor for Boron Trichloride			
DrägerSensor Acidic Compounds AC	6810595	1	

FIRE & GAS DETECTION SYSTEMS

PRODUCT	PART NO	PACKAGING UNIT	CATEGORY
Transmitter for Carbon monoxide			
Dräger Polytron 3000 CO 100 ppm	8316632	1	
Dräger Polytron 3000 CO 100 ppm Non Display	8316732	1	
Dräger Polytron 3000 CO 300 ppm	8316631	1	
Dräger Polytron 3000 CO 300 ppm Non Display	8316731	1	
Dräger Polytron 3000 CO 1000 ppm	8316630	1	
Dräger Polytron 3000 CO 1000 ppm Non Display	8316730	1	
Dräger Polytron 3000 CO LS 300 ppm	8316633	1	
Dräger Polytron 3000 CO LS 300 ppm Non Display	8316733	1	
Sensors for Carbon monoxide			
DrägerSensor CO	6809605	1	
DrägerSensor CO LS	6809620	1	
Transmitter for Chlorine			
Dräger Polytron 3000 Cl ₂ 1 ppm	8316647	1	
Dräger Polytron 3000 Cl ₂ 1 ppm Non Display	8316747	1	
Dräger Polytron 3000 Cl ₂ 10 ppm	8316648	1	
Dräger Polytron 3000 Cl ₂ 10 ppm Non Display	8316748	1	
Dräger Polytron 3000 Cl ₂ 25 ppm	8316649	1	
Dräger Polytron 3000 Cl ₂ 25 ppm Non Display	8316749	1	
Sensors for Carbon monoxide			
DrägerSensor Cl ₂	6809665	1	
Transmitter for Diborane			
Dräger Polytron 3000 B ₂ H ₆ 0.5 ppm	8316656	1	
Dräger Polytron 3000 B ₂ H ₆ 0.5 ppm Non Display	8316756		
Sensors for Carbon monoxide			
DrägerSensor Hydride SC	6809980	1	
Transmitter for Ethylene Oxide			
Dräger Polytron 3000 C ₂ H ₄ O 50 ppm	8316658	1	
Dräger Polytron 3000 C ₂ H ₄ O 50 ppm Non Display	8316758		
Sensors for Carbon monoxide			
DrägerSensor OV	6809615	1	

FIRE & GAS DETECTION SYSTEMS

PRODUCT	PART NO	PACKAGING UNIT	CATEGORY
Transmitter for Hydrogen			
Dräger Polytron 3000 H ₂ 3000 ppm	8316655	1	
Dräger Polytron 3000 H ₂ 3000 ppm Non Display	8316755	1	
Dräger Polytron 3000 H ₂ 1000 ppm	8316669	1	
Dräger Polytron 3000 H ₂ 1000 ppm Non Display	8316769	1	
Sensor for Hydrogen			
DrägerSensor H ₂	6809685	1	
Transmitter for Hydrogen Cyanide			
Dräger Polytron 3000 HCN 50 ppm	8316678	1	
Sensor for Hydrogen Cyanide			
DrägerSensor HCN	6809650	1	
Transmitter for Hydrogen Sulfide			
Dräger Polytron 3000 H ₂ S LC 20 ppm	8316634	1	
Dräger Polytron 3000 H ₂ S LC 20 ppm Non Display	8316734	1	
Dräger Polytron 3000 H ₂ S LC 50 ppm	8316635	1	
Dräger Polytron 3000 H ₂ S LC 50 ppm Non Display	8316735	1	
Dräger Polytron 3000 H ₂ S LC 100 ppm	8316636	1	
Dräger Polytron 3000 H ₂ S LC 100 ppm Non Display	8316736	1	
Sensor for Hydrogen Sulfide			
DrägerSensor H ₂ S	6810435	1	
Transmitter for Hydrides			
Dräger Polytron 3000 PH ₃ 0.3 ppm	8316653	1	
Dräger Polytron 3000 PH ₃ 0.3 ppm Non Display	8316753	1	
Dräger Polytron 3000 PH ₃ 1 ppm	8316667	1	
Dräger Polytron 3000 PH ₃ 1 ppm Non Display	8316767	1	
Dräger Polytron 3000 PH ₃ 10 ppm	8316668	1	
Dräger Polytron 3000 PH ₃ 10 ppm Non Display	8316768	1	
Sensor for Hydrides			
DrägerSensor Hydride	6809635	1	
Transmitter for Hydrogen			
Dräger Polytron 3000 H ₂ 3000 ppm	8316670	1	
Dräger Polytron 3000 H ₂ 3000 ppm Non Display	8316770	1	
Sensor for Hydrogen Cyanide			
DrägerSensor HCl	6809640	1	

FIRE & GAS DETECTION SYSTEMS

PRODUCT	PART NO	PACKAGING UNIT	CATEGORY
Transmitter for Nitric Oxide			
Dräger Polytron 3000 NO LC 50 ppm	8316640	1	
Dräger Polytron 3000 NO LC 50 ppm Non Display	8316740	1	
Sensor for Nitric Oxide			
DrägerSensor NO	6809625	1	
Transmitter for Nitrogen Dioxide			
Dräger Polytron 3000 NO ₂ 10 ppm	8316641	1	
Dräger Polytron 3000 NO ₂ 10 ppm Non Display	8316741	1	
Sensor for Nitric Oxide			
DrägerSensor NO ₂	6809655	1	
Transmitter for Hydrazine			
Dräger Polytron 3000 N ₂ H ₄ 1 ppm O ₂	8316650	1	
Dräger Polytron 3000 N ₂ H ₄ 1 ppm Non Display	8316750	1	
Sensor for Hydrazine			
DrägerSensor N ₂ H ₄	6810180	1	
Transmitter for Oxygen			
Dräger Polytron 3000 O ₂ 5 Vol.-%	8316642	1	
Dräger Polytron 3000 O ₂ 5 Vol.-% Non Display	8316742	1	
Dräger Polytron 3000 O ₂ 25 Vol.-%	8316643	1	
Dräger Polytron 3000 O ₂ 25 Vol.-% Non Display	8316743	1	
Dräger Polytron 3000 O ₂ 2 100 Vol.-%	8316644	1	
Dräger Polytron 3000 O ₂ 100 Vol.-% Non Display	8316744	1	
Dräger Polytron 3000 O ₂ LS 25 Vol.-%	8316645	1	
Dräger Polytron 3000 O ₂ LS 25 Vol.-% Non Display	8316745	1	
Sensors for Oxygen			
DrägerSensor O ₂ LS	6809630	1	
DrägerSensor O ₂	6809720	1	
Transmitter for Ozone			
Dräger Polytron 3000 O ₃ 0.5 ppm	8316665	1	
Dräger Polytron 3000 O ₃ 0.5 ppm Non Display	8316765	1	
Sensor for Ozone			
DrägerSensor Ozone	6814005	1	

Dräger Polytron 3000 SO₂ 10 ppm

05

FIRE & GAS DETECTION SYSTEMS

PRODUCT	PART NO	PACKAGING UNIT	CATEGORY
Transmitter for Sulfur Dioxide			
Dräger Polytron 3000 SO ₂ 10 ppm	8316646	1	
Dräger Polytron 3000 SO ₂ 10 ppm Non Display	8316746	1	
Sensor for Sulfur Dioxide			
DrägerSensor SO ₂	6809660	1	
Docking Station	8317990	1	
Safety barrier zone 2	8323873	1	
Manuals			
IFU Dräger Polytron 3000 - German (Not included in transmitter)	9023785	1	
IFU Dräger Polytron 3000 - English	9033020	1	
IFU Dräger Polytron 3000 - Spanish	9033021	1	
IFU Dräger Polytron 3000 - French	9033022	1	
IFU Dräger Polytron 3000 - Dutch	9033023	1	
IFU Dräger Polytron 3000 - Swedish	9033024	1	
IFU Dräger Polytron 3000 - Portuguese	9033385	1	
Accessories			
Dräger PSD 3000	8319270	1	
Duct mount kit Polytron 3000/7000	8317150	1	
Mounting set P2IR/P3000/P7000	6809951	1	
Calibration adapter V	6810536	1	
Gassing adapter PE	6806978	1	
Calibration-/process adapter AC	6809380	1	
Calibration-/process adapter 2 AC	8324093	1	
Splash guard AC L	6809379	1	
Set Hawke cable gland Polytron 3000 / 7000	8319029	1	
Splash guard	6812510	1	

FIRE & GAS DETECTION SYSTEMS

PRODUCT	PART NO	PACKAGING UNIT	CATEGORY
---------	---------	----------------	----------

TOXIC CO₂ DETECTORS

The Dräger PIR 7200 is an explosion proof gas detector for continuous monitoring of **Carbon Dioxide** in suitable atmospheres.

The measuring range can be adjusted from 0 to 2,000 ppm and up to 30 % (v/v), and the operating temperature is specified up to + 45 °c . Its robust design (offering a stainless steel 316L enclosure), the wide range of accessories and the SIL 2 compatibility (certified by the German TUV) make the Dräger PIR 7200 suitable for all industrial environments. Manual Included.

Ranges: 0

DRAEGER PIR 7200			
Transmitter			
Dräger PIR 7200 (NPT) HART	6811572	1	
Dräger PIR 7200 (NPT) HART complete set With Ex d junction box (made of stainless steel 316), splash guard, status indicator and mounting set, already pre-assembled	6813055	1	
Dräger PIR 7200 (NPT) HART complete set With Ex d junction box (made of aluminum), splash guard, status indicator and mounting met, already pre-assembled	6813050	1	
Dräger PIR 7200 (M25) HART	6811570	1	
Dräger PIR 7200 (M25) HART complete set With Ex e junction box incl. M20 cable gland, splash guard, status indicator and mounting set, already pre-assembled	6812290	1	
Dräger PIR 7200 Customised (built-to-order) Configuration (mandatory) Assembly fee for accessories (optional)	6811790	1	
Manuals			
IFU Dräger PIR 7000 / PIR 7200 (Included in transmitter)	9023885	1	
Technical handbook PIR 7000 / 7200 (Not included in transmitter)	6811993	1	

FIRE & GAS DETECTION SYSTEMS

PRODUCT	PART NO	PACKAGING UNIT	CATEGORY
Accessories			
Mounting set PIR 7000	6811648	1	
Duct mount set PIR 7000	6811850	1	
Duct mount kit Polytron IR X7X0	6812300	1	
Splash guard PIR 7200	6811912	1	
Insect guard PIR 7000	6811609	1	
Hydrophobic filter PIR 7000	6811890	1	
Calibration adapter PIR 7000	6811610	1	
Status indicator PIR 7200	6811920	1	
Flowcell PIR 7200	6811910	1	
Flowcell PIR 7000 duct	6811945	1	
Bump test adapter PIR 7200	6811930	1	
Bump test adapter PIR 7000 duct	6811990	1	
Process adapter PIR 7000	6811915	1	
Process cuvette PIR 7000	6811415	1	
Process cuvette PIR 7000 SGR	6813219	1	
Magnetic wand	4544101	1	
Dräger RAB 7000 Remote-Access-Box	6812830	1	
USB PC adapter PIR 7000	6811663	1	
Junction box Ex e PIR 7000	6811898	1	
Junction box Ex d stainless steel	4544098	1	
Junction box Ex d aluminium	4544099	1	



Place You Put Your Faith

FIRE & GAS DETECTION SYSTEMS

PRODUCT	PART NO	PACKAGING UNIT	CATEGORY
---------	---------	----------------	----------



Dräger Polytron 5720 IR is a cost-effective explosion proof transmitter for the detection of carbon dioxide gas using a PIR 7200 IR sensor. 3 wire 4-20 mA output with relays make it compatible with most control systems. You can choose between explosion proof "d" (USA) or flame proof increased safety "e" version (Europe) and aluminum (A) or stainless steel (S). All stainless steel (S) versions include stainless steel blind plugs.

*The docking station (E-Box) is included with every "e" version. A configurable part number 8344500 is available for stainless steel variants. Please calculate the total price by adding the options below to the base price.

Standard Unit - requires Polytron 5720 + Splashguard + Status Indicator.

Inline Application - requires Polytron 5720 + Process Cuvette (Steel) or Process adaptor (plastic)

d = Exd version, A =Aluminium, S =Stainless Steel

DRÄGER Polytron 5720 Ex d (Approval ATEX, IEC Ex, UL, CSA)			
Steel variants need to be configured using Polytron configurator online, and must accompany all order.			
Part number 8344500 is a common configurable part number.			
Ex d Versions (Remote versions require Exd Junction box)			
Polytron 5720 d AL with Status Indicator & Splash guard	8344200	1	G
Polytron 5720 d AL relay with Status Indicator & Splash guard	8344201	1	G
Polytron 5720 d SS	8344500	1	G
Polytron 5720 d SS relay	8344500	1	G
Dräger Polytron 5720 IR e A*	8344204	1	G
Dräger Polytron 5720 IR e A relay*	8344205	1	G
Junction Box SS (required for remote d installation)	4544098	1	G
Junction Box AL (required for remote d installation)	4544099	1	G
Accessories			
Splash Guard (not compatible with all sensors)	6812510	1	
Magnetic Wand (blue body, white logo)	4544101	1	
Gassing / Calibration Adapter (white silicone)	6806978	1	
Calibration Adapter V (black rubber)	6810536	1	
EC Sensing Head Remote w/ wall mount kit (requires cable)	6812684	1	
Remote Cable + Plug (5m)	8323305	1	
Remote Cable + Plug (15m)	8323315	1	
Remote Cable + Plug (30m)	8323330	1	
Duct Adapter for EC Sensing Head Remote (min 10 cm diameter)	8317617	1	
Process Adapter RS EC Stainless Steel Remote Sensor	8323404	1	
Duct Mount Kit Polytron 5x00/8x00 non IR	6812725	1	

FIRE & GAS DETECTION SYSTEMS

PRODUCT	PART NO	PACKAGING UNIT	CATEGORY
Calibration Bottle for Use with Test Gas Ampoules	6803407	1	
Pole Mount Kit Polytron 5x0/8x0	4544198	1	
Docking Station/ E-Box Polytron 5x0/8x0 Power	8344027	1	
Docking Station/ E-Box Polytron 5x0/8x0 for relay/remote	8344028	1	
Cable Gland for Docking Station / E-Box	6812868	1	
Blind Plug 316L St. Steel 3/4"NPT for SS Housing	4544897	1	
Dräger PolySoft Configuration Software	8323405	1	
IR Connection Kit (requires PolySoft)	4544197	1	



Place You Put Your Faith

FIRE & GAS DETECTION SYSTEMS

PRODUCT	PART NO	PACKAGING UNIT	CATEGORY
---------	---------	----------------	----------



The Draeger Polytron 8720 is an explosion proof gas detector for continuous monitoring of **Carbon Dioxide** in suitable atmospheres. Its SIL 2 compatibility is proven by a full H/W & S/W assessment and certified by the German TÜV. All functions are accessible through the display including calibration and target gas. Status LED's are provided on the display. Options of Aluminium or SS 316 Enclosure and Relays (A1, A2 & Fault)

Remote sensor with Display is possible using the Exd Junction Box . Flow-cell available for remote calibration.

The measuring range can be adjusted from 0 to 9,990 ppm and up to 30 %(v/v), and the operating temperature is specified up to + 45 °c .

Standard Unit - requires Polytron 8720 + Splashguard + Status Indicator

Inline Application - requires Polytron 8720 + Process Cuvette (Steel) or Process adaptor (plastic)

d = Exd version, A =Aluminium, S =Stainless Steel

DRÄGER Polytron 8720 Ex d (Approval ATEX, IEC Ex, UL, CSA) with HART, SIL 2 (IEC61508) Steel variants need to be configured using Polytron configurator online, and must accompany all order. Part number 8344800 is a common configurable part number.			
Ex d Versions (Remote versions require Exd Junction box)			
Polytron 8720 d A 4-20/HART with Status Indicator & Splash guard	8344709	1	G
Polytron 8720 d A 4-20/HART relay with Status Indicator & Splash guard	8344710	1	G
Polytron 8720 d S 4-20/HART	8344800	1	G
Polytron 8720 d S 4-20/HART relay	8344800	1	G
Junction Box S	4544098	1	G
Junction Box A	4544099	1	G
Ex e Versions (Require appropriate E-Box for complete set)			
Polytron 8720 e A 4-20/HART with Status Indicator & Splash guard	8344727	1	G
Polytron 8720 e A 4-20/HART relay with Status Indicator & Splash guard	8344728	1	G
Polytron 8720 e S 4-20/HART	8344800	1	G
Polytron 8720 e S 4-20/HART relay	8344800	1	G
E-box Power only version (Includes 1 cable gland) / Docking station	6812420	1	G
E-box Power and Relay version (Includes 2 cable glands) / Docking station	6812275	1	G
Remote E Versions (Require E-Box and Sensor PIR 7200 - Part # 6812290)			
Polytron 8720 Remote e A 4-20/HART	8344800	1	G
Polytron 8720 Remote e A 4-20/HART relay	8344800	1	G
Polytron 8720 Remote e S 4-20/HART	8344800	1	G

FIRE & GAS DETECTION SYSTEMS

PRODUCT	PART NO	PACKAGING UNIT	CATEGORY
Polytron 8720 Remote e S 4-20/HART relay	8344800	1	G
E-box Power only version (Includes 1 cable gland) / Docking station	6812420	1	G
E-box Power and Relay version (Includes 2 cable glands) / Docking station	6812275	1	G
Dräger PIR 7200 (M25) HART cpl. Set with Ex e junction box, splash guard, status indicator and mounting set, pre-assembled.	6812290	1	G
Accessories			
Splash Guard PIR 7200	6811912	1	G
Status Indicator PIR 7200	6811920	1	G
Process Adapter PIR 7000 (Plastic)	6811915	1	G
Process Cuvette PIR 7000 SGR	6813219	1	G
Insect Guard PIR 7000	6811609	1	G
Hydrophobic Filter PIR 7000	6811890	1	G
Calibration Adapter PIR 7000	6811610	1	G
Flowcell PIR 7200	6811910	1	G
Bump Test Adapter PIR 7200	6811930	1	G
Magnet W/Key Chain P5000/8000	4544101	1	G
Irda Interface Assy	4544197	1	G
Pipe Mount Kit P5x00 /8x00	4544198	1	G
Duct Mount Kit Polytron 5700/8700/5720/8720	6812300	1	G

FIRE & GAS DETECTION SYSTEMS

PRODUCT	PART NO	PACKAGING UNIT	CATEGORY
---------	---------	----------------	----------

ACCOUSTIC GAS LEAK DETECTOR



The Polytron 8900 UGLD is an acoustic gas leak detector for detecting high pressure (>10 bar) toxic and combustible gas leaks. It includes an ultrasonic microphone sensor with a 120 degree circular angle of detection. Sensor has a range of 0-100% corresponding to 56 to 115 dBA and ships fully calibrated, ready for operation. It comes standard with an analog 3 wire 4-20mA/HART output. Relays are included but are not functional until a future firmware update.

The 316L stainless steel enclosure is explosion proof Ex d.

Available for sale 3st Quarter 2019.

Polytron 8900 Transmitter			
Dräger Polytron 8900 UGLD d S 4-20/HART relay	8328030	1	
Accessories			
Magnetic Wand (blue body, white logo)	4544101	1	
EC Sensing Head Remote UGLD w/ wall mount kit (requires cable)	8328021	1	
Remote Cable + Plug (5m)	8323305	1	
Remote Cable + Plug (15m)	8323315	1	
Remote Cable + Plug (30m)	8323330	1	
Pole Mount Kit Polytron 5xx0/8xx0	4544198	1	
Blind Plug 316L St. Steel 3/4"NPT for SS Housing (2)	4544897	1	
UGLD Calibration and Bump Test Kit with Carrying Case (w/o Cal Gas) Includes cylinder regulator, tubing, and remote sound generator	8328012	1	
Zero Air Gas Cylinder 112L for Calibration and Bump Test Kit.	6813239	1	
UGLD Sensor SPPT (DrägerService Exclusive)	8328045	1	
Dräger PolySoft Configuration Software	8323405	1	
IR Connection Kit (requires PolySoft)	4544197	1	

FIRE & GAS DETECTION SYSTEMS

PRODUCT	PART NO	PACKAGING UNIT	CATEGORY
---------	---------	----------------	----------

FLAMMABLE - IR GAS DETECTORS



The Draeger PIR 7000 is an explosion proof gas detector for continuous monitoring of **flammable gases and vapours** in suitable atmospheres. The gas library can be customised with up to 13 substances (Approx 52 gas libraries available) and the t0..90 response time can be configured to "fast", i.e. less than 1 second. Its SIL 2 compatibility is proven by a full H/W & S/W assessment and certified by the German TÜV. Bumpstest Adaptor available for remote calibration.

Type 334 - To detect Methane and lighter hydrocarbons

Range: 0 - 9990 PPM, 0 - 100 % LEL, 0 - 100 Vol. % CH4 (Default - Methane)

Type 340 - Propane and heavier hydrocarbons (Fuels)

Range: 0 - 9990 PPM, 0 - 100 % LEL, (Default - Propane)

Check Gaslist for details and selection of correct type.

DRÄGER PIR 7000 (Approval ATEX, IEC Ex, UL, CSA) with HART, SIL 2 (IEC61508) (Exd Versions available on request)			
Transmitter			
Dräger PIR 3000 (M25)	6810 810	1	
Dräger PIR 3000 (NPT)	6811 080	1	
Dräger PIR 3000 complete set e (With regular Ex e junction box)	6811160	1	
Dräger PIR 3000 complete set e2 (With octa Ex e junction box)	6811270	1	
Dräger PIR 3000 complete set d	6811180	1	
Dräger PIR 3000 complete set d CCCF	6812505	1	
Change of gas category (Via SAP configurator)		1	
Accessories			
Mounting Set PIR 7000	6811648	1	G
Duct Mount Set PIR 7000	6811850	1	G
Splash Guard PIR 7000	6811911	1	G
Status Indicator PIR 7000	6811625	1	G
Hydrophobic Filter PIR 7000	6811890	1	G
Flowcell PIR 7000	6811490	1	G
Flowcell PIR 7000 Duct	6811945	1	G
Bump Test Adapter PIR 7000	6811630	1	G
Bump Test Adapter PIR 7000 Duct	6811990	1	G
Process Cuvette PIR 7000 SGR	6813219	1	G
Magnetic Wand	4544101	1	G
USB PC Adapter PIR 7000	6811663	1	G
Junction Box Ex e PIR 7000	6811898	1	G

Dräger Region South East Europe | Rev: 0 | Subject to modification! | www.draeger.com

FIRE & GAS DETECTION SYSTEMS

PRODUCT	PART NO	PACKAGING UNIT	CATEGORY
---------	---------	----------------	----------



The Draeger Polytron 5700 is an explosion proof gas detector for continuous monitoring of flammable gases and vapours in suitable atmospheres. The gas library come pre-loaded with approx. 50 gases. All functions are accessible through the display including calibration and target gas. Status LED's are provided on the display. Options of Aluminium or SS 316 Enclosure and Relays (A1, A2 & Fault). Check Gaslist for details and selection of correct type.

Remote sensor with Display is possible using the Exd housing . Bumpstest Adaptor available for remote calibration/Testing.

Type 334 - To detect Methane and lighter hydrocarbons

Range: 0 - 9990 PPM, 0 - 100 % LEL, 0 - 100 Vol. % CH4 (Default - Methane)

Type 340 - Propane and heavier hydrocarbons (Fuels) Range: 0 - 9990 PPM, 0 - 100 % LEL, (Default - Propane)

Standard Unit - requires Polytron 5700 + Splashguard + Status Indicator

Inline Application - requires Polytron 5700 + Process Cuvette (Steel) or Process adaptor (plastic)

DRÄGER Polytron 5700 Ex d (Approval ATEX, IEC Ex, UL, CSA)			
Steel variants need to be configured using Polytron configurator online, and must accompany all order.			
Part number 8344500 is a common configurable part number.			
Ex d Versions (Remote versions require Exd Junction box)			
Polytron 5700, 334 d Aluminium with Status Indicator & Splash guard	8344220	1	G
Polytron 5700, 334 d Aluminium relay with Status Indicator & Splash guard	8344221	1	G
Polytron 5700, 334 d Stainless Steel with Status Indicator & Splash guard	8344222	1	G
Polytron 5700, 334 d Stainless Steel relay	8344500	1	G
Polytron 5700, 340 d Aluminium with Status Indicator & Splash guard	8344240	1	G
Polytron 5700, 340 d Aluminium relay with Status Indicator & Splash guard	8344241	1	G
Polytron 5700, 340 d Stainless Steel	8344500	1	G
Polytron 5700, 340 d Stainless Steel relay	8344500	1	G
Dräger Polytron 5700 IR 334 e A*	8344224	1	G
Dräger Polytron 5700 IR 334 e A relay*	8344225	1	G
Dräger Polytron 5700 IR 340 e A*	8344244	1	G
Dräger Polytron 5700 IR 340 e A relay*	8344245	1	G
Remote Junction Box			
Junction Box S	4544098	1	G
Junction Box A	4544099	1	G
Accessories			
Docking Station/ E-Box (w/ 1 cable gland)	6812420	1	G
Docking Station/ E-Box for relay/remote (w/ 2 cable glands)	6812275	1	G
Process Adapter (cuvette) PIR 7x00 (stainless steel)	6811415	1	G
Splash Guard PIR 7000	6811911	1	G
Status Indicator PIR 7000	6811625	1	G
Process Adapter PIR 7000 (Plastic)	6811915	1	G
Process Cuvette PIR 7000 SGR	6813219	1	G

Dräger Region South East Europe | Rev: 0 | Subject to modification! | www.draeger.com

FIRE & GAS DETECTION SYSTEMS

PRODUCT	PART NO	PACKAGING UNIT	CATEGORY
Remote Junction Box			
Insect Guard PIR 7000	6811911	1	G
Hydrophobic Filter PIR 7000	6811890	1	G
Calibration Adapter PIR 7000	6811610	1	G
Flowcell PIR 7000	6811490	1	G
Flowcell PIR 7000 Duct	6811945	1	G
Bump Test Adapter PIR 7000	6811630	1	G
Bump Test Adapter PIR 7000 Duct	6811990	1	G
Magnet W/Key Chain P5000/8000	4544101	1	G
Irda Interface Assy	4544197	1	G
Pipe Mount Kit P5x00 /8x00	4544198	1	G
Duct Mount Kit Polytron 5700/8700/5720/8720	6812300	1	G
Flowcell PIR 7000 Duct	6811945	1	G
Bump Test Adapter PIR 7000 Duct	6811990	1	G

FIRE & GAS DETECTION SYSTEMS

PRODUCT	PART NO	PACKAGING UNIT	CATEGORY
---------	---------	----------------	----------

The Polytron 8700 IR is Dräger's top of the line explosion proof transmitter for the detection of combustible gas in the ppm and %LEL range with a PIR7000 infrared sensor. It comes standard with an analog 3 wire 4-20mA HART output. Relays and fieldbus interface module are optional. You can choose between explosion proof "d" (USA) or flame proof increased safety "e" version (Europe) and aluminum (A) or stainless steel (S). All stainless steel (S) versions include stainless steel blind plugs.



*The docking station (E-Box) is included with every "e" version. A configurable part number 8344800 is available for some stainless steel and all fieldbus options. Please calculate the total price by adding the options below to the base price.

Remote sensor with Display is possible using the Exd housing . Bumptest Adaptor available for remote calibration/Testing.

Type 334 - To detect Methane and lighter hydrocarbons

Range: 0 - 9990 PPM, 0 - 100 % LEL, 0 - 100 Vol. % CH4 (Default - Methane)

Type 340 - Propane and heavier hydrocarbons (Fuels)

Range: 0 - 9990 PPM, 0 - 100 % LEL, (Default - Propane)

Standard Unit - requires Polytron 8700 + Splashguard + Status Indicator

Inline Application - requires Polytron 8700 + Process Cuvette (Steel) or Process adaptor (plastic)

DRÄGER Polytron 8700 Ex d (Approval ATEX, IEC Ex, UL, CSA) with HART, SIL 2 (IEC61508)

Steel variants need to be configured using Polytron configurator online, and must accompany all order.

Part number 8344800 is a common configurable part number.

Type 334 Ex d Versions (Remote versions require Exd Junction box)

Polytron 8700 334 d AL with Status Indicator & Splash guard	8344601	1	G
Polytron 8700 334 d AL relay with Status Indicator & Splash guard	8344602	1	G
Polytron 8700 334 d SS with Status Indicator & Splash guard	8344610	1	G
Polytron 8700 334 d SS relay with Status Indicator & Splash guard	8344611	1	G
Junction Box S	4544098	1	G
Junction Box A	4544099	1	G

Type 334 Ex e Versions (Requires appropriate E-box to complete set)

Polytron 8700 334 e AL with Status Indicator & Splash guard	8344619	1	G
Polytron 8700 334 e AL relay with Status Indicator & Splash guard	8344620	1	G
Polytron 8700 334 e SS	8344800	1	G
Polytron 8700 334 e SS relay	8344800	1	G
E-box Power only version (Includes 1 cable gland) / docking station	6812420	1	G
E-box Power and Relay version (Includes 2 cable glands) / Docking station	6812275	1	G

Type 334 Remote E Versions (Requires E-Box & PIR 7000 type 334 - Part # 6811817)

Display Polytron 8700 Remote 334 e AL without sensor	8344800	1	G
--	---------	---	---

Dräger Region South East Europe | Rev: 0 | Subject to modification! | www.draeger.com

Place You Put Your Faith
PORTABLE GAS DETECTION

PERSONAL PROTECTION EQUIPMENT

DRUG & ALCOHOL DETECTION

MASKS & FILTERS

FIRE & GAS DETECTION SYSTEMS

ENGINEERED SOLUTIONS

SERVICE, TRAINING & RENTAL

DIVING TECHNOLOGY

FIRE & GAS DETECTION SYSTEMS

PRODUCT	PART NO	PACKAGING UNIT	CATEGORY
Display Polytron 8700 Remote 334 e AL Relay without sensor	8344800	1	G
Display Polytron 8700 Remote 334 e SS without sensor	8344800	1	G
Display Polytron 8700 Remote 334 e SS Relay without sensor	8344800	1	G
E-box Power only version (Includes 1 cable gland) / docking station	6812420	1	G
E-box Power and Relay version (Includes 2 cable glands) / Docking station	6812275	1	G
Dräger PIR 7000 type 334 (M25) HART cpl. Set with Ex e junction box , splash guard, status indicator and mounting set, already pre-assembled	6811817	1	G
Type 340 Ex d Versions (Remote versions require Exd Junction box)			
Polytron 8700 340 d AL with Status Indicator & Splash guard	8344637	1	G
Polytron 8700 340 d AL relay with Status Indicator & Splash guard	8344638	1	G
Polytron 8700 340 d SS	8344800	1	G
Polytron 8700 340 d SS relay	8344800	1	G
Junction Box S	6812420	1	G
Junction Box A	6812275	1	G
Type 340 Ex e Versions (Require appropriate E-Box for complete set)			
Polytron 8700 340 e AL with Status Indicator & Splash guard	8344655	1	G
Polytron 8700 340 e AL relay with Status Indicator & Splash guard	8344656	1	G
Polytron 8700 340 e SS	8344800	1	G
Polytron 8700 340 e SS relay	8344800	1	G
E-box Power only version (Includes 1 cable gland) / docking station	6812420	1	G
E-box Power and Relay version (Includes 2 cable glands) / Docking station	6812275	1	G
Type 340 Remote E Versions (Requires E-Box & PIR 7000 type 340 - Part # 6811819)			
Display Polytron 8700 Remote 340 e AL without sensor	8344800	1	G
Display Polytron 8700 Remote 340 e AL Relay without sensor	8344800	1	G
Display Polytron 8700 Remote 340 e SS without sensor	8344800	1	G
Display Polytron 8700 Remote 340 e SS Relay without sensor	8344800	1	G
E-box Power only version (Includes 1 cable gland) / docking station	6812420	1	G
E-box Power and Relay version (Includes 2 cable glands) / Docking station	6812275	1	G
Dräger PIR 7000 type 340 (M25) HART cpl. Set with Ex e junction box , splash guard, status indicator and mounting set, already pre-assembled	6811819	1	G
Adapter /Mounting Plate for PIR 7000/ Polytron 8700			
Accessories			
Splash Guard PIR 7000	6811911	1	G
Status Indicator PIR 7000	6811625	1	G
Process Adapter PIR 7000 (Plastic)	6811915	1	G
Process Cuvette PIR 7000 SGR	6813219	1	G

FIRE & GAS DETECTION SYSTEMS

PRODUCT	PART NO	PACKAGING UNIT	CATEGORY
Accessories			
Insect Guard PIR 7000	6811911	1	G
Hydrophobic Filter PIR 7000	6811890	1	G
Calibration Adapter PIR 7000	6811610	1	G
Flowcell PIR 7000	6811490	1	G
Flowcell PIR 7000 Duct	6811945	1	G
Bump Test Adapter PIR 7000	6811630	1	G
Bump Test Adapter PIR 7000 Duct	6811990	1	G
Magnet W/Key Chain P5000/8000	4544101	1	G
Irda Interface Assy	4544197	1	G
Pipe Mount Kit P5x00 /8x00	4544198	1	G
Duct Mount Kit Polytron 5700/8700/5720/8720	6812300	1	G
Flowcell PIR 7000 Duct	6811945	1	G
Bump Test Adapter PIR 7000 Duct	6811990	1	G
3/4" NPT Male to M25 Female Adapter - EExd (IECEX)		1	G
3/4" NPT Exd Compound Barrier Gland IECEX Approved		1	G

FIRE & GAS DETECTION SYSTEMS

PRODUCT	PART NO	PACKAGING UNIT	CATEGORY
---------	---------	----------------	----------



The Draeger PIR 3000 is an explosion proof gas detector for continuous monitoring of flammable gases and vapours in the ambient air.

The transmitter is built for harsh industrial environments (stainless steel 316 enclosure) and it features reliability and accuracy.

Non-intrusive calibration is recommended every 6 to 12 months only.

Also suitable for selected refrigerant gas monitoring

DRÄGER PIR 3000 (Approval IEC Ex, ATEX, UL, CSA)			
Transmitter			
Dräger PIR 3000 complete set e (with regular Ex e junction box)	6811160	1	G
Dräger PIR 3000 complete set e2 (with octa Ex e junction box)	6811270	1	G
Dräger PIR 3000 complete set d (with Ex d junction box)	6811180	1	G
Sensor only (without Junction Box)			
Dräger PIR 3000 (M25) without enclosure	6810810	1	G
Dräger PIR 3000 (NPT) without enclosure	6811080	1	G
Accessories			
DSIR Splash Guard	6810796	1	G
DSIR Calibration Adapter	6810859	1	G
DSIR Gassing / Process Adapter	6811330	1	G
DSIR Weather Guard	6811135	1	G
Mounting Set e	6811427	1	G
Mounting Set d	6811426	1	G
DSIR Duct Mount Set	6810995	1	G
Magnet W/Key Chain P5000/8000	4544101	1	G
Junction Box EEx e (regular box)	6811299	1	G
Junction Box EEx e (octa box)	6811159	1	G
Junction Box EEx d	6811161	1	G
DSIR Cable Gland M20 set	6811323	1	G
DSIR Duct Mount Set	6810995	1	G

FIRE & GAS DETECTION SYSTEMS

PRODUCT	PART NO	PACKAGING UNIT	CATEGORY
---------	---------	----------------	----------



The Dräger Polytron 5310 IR is a cost-effective explosion proof transmitter for the detection of combustible gas using an infrared sensor. 3 wire 4-20 mA output with relays make it compatible with most control systems. You can choose between explosion proof "d" (USA) or flame proof increased safety "e" version (Europe) and aluminum (A) or stainless steel (S). All stainless steel (S) versions include stainless steel blind plugs. *The docking station (E-Box) is included with every "e" version.

Three-wire, 10 to 30 VDC

Non-intrusive calibration using a magnetic wand

3 digit LCD display

4 to 20 mA output

Polytron 5310 (IEC Ex, ATEX Approved)

All Polytron 5310 models need to be configured using polytron configurator online, and must accompany all order.

Part number 8344500 is a common configurable part number.

Polytron 5310, d Aluminium	8344370	1	G
Polytron 5310, d Aluminium with Relay	8344500	1	G
Polytron 5310, d Stainless Steel	8344500	1	G
Polytron 5310, d Stainless Steel with Relay	8344500	1	G
Remote Junction Box			
Junction Box S	4544098	1	G
Junction Box A	4544099	1	G
Accessories			
Magnet W/Key Chain P5000/8000	4544101	1	G
Irda Interface Assy	4544197	1	G
Pipe Mount Kit P5x00 /8x00	4544198	1	G
Duct Mount Kit	6812725	1	G
DSIR Splash Guard	6810796	1	G
DSIR Calibration Adapter	6810859	1	G
DSIR Gassing / Process Adapter	6811330	1	G
DSIR Weather Guard	6811135	1	G
Docking Station/ E-Box (w/ 1 cable gland)	6812420	1	G
Docking Station/ E-Box for relay/remote (w/ 2 cable glands)	6812275	1	G
Spare Sensor			
Dräger Sensor IR (NPT)	6811901	1	G

3/4" NPT to M20/M25 Adapters & Glands

More information in chapter "General Accessories"

FIRE & GAS DETECTION SYSTEMS

PRODUCT	PART NO	PACKAGING UNIT	CATEGORY
---------	---------	----------------	----------



The Polytron 8310 IR is Dräger's top of the line explosion proof transmitter for the detection combustible gas with a DrägerSensor IR. It comes standard with an analog 3 wire 4-20mA HART output. Relays and fieldbus interface module are optional. You can choose between explosion proof "d" (USA) or flame proof increased safety "e" version (Europe) and aluminum (A) or stainless steel (S).

All stainless steel (S) versions include stainless steel blind plugs.

*The docking station (E-Box) is included with every "e" version. A configurable part number 8344800 is available for some stainless steel and all fieldbus options. Please calculate the total price by adding the options below to the base price

Three-wire, 10 to 30 VDC, Non-intrusive calibration using a magnetic wand
4 digit LCD display, 4 to 20 mA output

Polytron 8310 (IEC Ex, ATEX Approved) with HART Some Polytron 8310 models need to be configured using Polytron configurator online, and must accompany all order. Part number 8344800 is a common configurable part number.			
Transmitter Ex d Versions (Remote versions require Exd Junction boxes)			
Polytron 8310 d Aluminium 4-20/HART"	8344807	1	G
Polytron 8310 d Aluminium 4-20/HART with Relay	8344808	1	G
Polytron 8310 d Stainless Steel 4-20/HART	8344800	1	G
Polytron 8310 d Stainless Steel 4-20/HART with Relay	8344800	1	G
Junction Box S	4544098	1	G
Junction Box A	4544099	1	G
Transmitter Ex e Versions (Require appropriate E-Box for complete set)			
Polytron 8310 e A 4-20/HART	8344825	1	G
Polytron 8310 e A 4-20/HART relay	8344826	1	G
Polytron 8310 e S 4-20/HART	8344800	1	G
Polytron 8310 e S 4-20/HART relay	8344800	1	G
E-box Power only version (Includes 1 cable gland) / docking station	6812420	1	G
E-box Power and Relay version (Includes 2 cable glands) / Docking station	6812275	1	G
Accessories			
Magnet W/Key Chain P5000/8000	4544101	1	G
Irda Interface Assy	4544197	1	G
Pipe Mount Kit P5x00 /8x00	4544198	1	G
Duct Mount Kit	6812725	1	G
DSIR Splash Guard	6810796	1	G
DSIR Calibration Adapter	6810859	1	G
DSIR Gassing / Process Adapter	6811330	1	G
DSIR Weather Guard	6811135	1	G
Spare Sensor			
Dräger Sensor IR (NPT)	6811901	1	G

FIRE & GAS DETECTION SYSTEMS

PRODUCT	PART NO	PACKAGING UNIT	CATEGORY
---------	---------	----------------	----------



The sensing head Polytron SE-Ex... DD is the most economical, yet reliable and proven solution for a combustible gas and vapour monitoring system. Based on the catalytic bead measuring principle the DrägerSensor of type dd provides a longterm-stable signal. Sensing head Polytron SE-Ex is intended to be connected to the controllers regard or Regard-1 and Polytron SE-Ex.

Dräger Polytron SE Ex		
Sensing Heads		
Polytron SE Ex PR M1 DD Small standard housing	6812711	1
Polytron SE Ex PR M2 DD Midsize standard housing	6812710	1
Polytron SE Ex PR NPT1 DD Flameproof metal housing	6812800	1
Sensors		
DrägerSensor PR M DD	6812220	1
DrägerSensor PR NPT DD	6812380	1
Sensing Heads		
Polytron SE Ex LC M1 DD Small standard housing	6812722	1
Polytron SE Ex LC M2 DD Midsize standard housing	6812721	1
Sensors		
DrägerSensor Ex-Sensor LC M	6810350	1
DrägerSensor Ex-Sensor LC NPT	6810675	1
Sensing Head		
Polytron SE Ex HT M DD Galvanized cast iron housing	6812720	1
Sensors		
DrägerSensor HT M DD	6812390	1
Instruction for use		
IFU-Sensing Head Polytron SE Ex.. DD, de, en	9033176	1
IFU-Sensing Head Polytron SE Ex.. DD, es, fr	9033274	1
IFU-Sensing Head Polytron SE Ex.. DD, nl, pt	9033275	1
IFU-Sensing Head Polytron SE Ex.. DD, el, it	9033313	1
IFU-Sensing Head Polytron SE Ex.. DD, da, no	9033314	1
IFU-Sensing Head Polytron SE Ex.. DD, fi, sv	9033315	1
IFU-Sensing Head Polytron SE Ex.. DD, cs, pl	9033316	1
IFU-Sensing Head Polytron SE Ex.. DD, hu	9033317	1

FIRE & GAS DETECTION SYSTEMS

PRODUCT	PART NO	PACKAGING UNIT	CATEGORY
Accessories			
Calibration adapter V	6810536	1	
Gasing adapter PE	6806978	1	
Dust filter disk 10 pcs. (Not suitable for DrägerSensor Ex LC M and HT M)	6810537	1	
Special tool PEX 3000 (for WAGO Terminals)	8318376	1	
Splash guard	6812510	1	
Process adapter DD	6812470	1	
Process adapter LC	6812465	1	
Remote calibration adapter DD	6812480	1	
Remote calibration adapter LC	6812482	1	

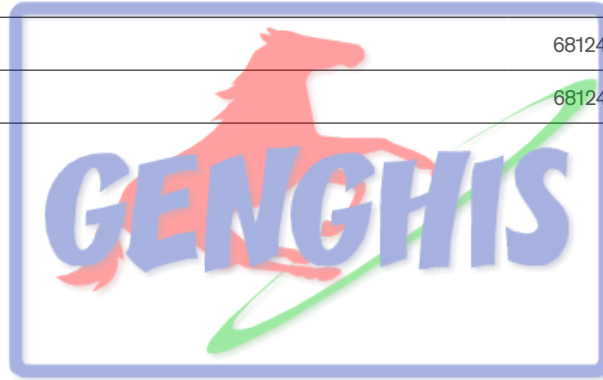

Place You Put Your Faith

FIRE & GAS DETECTION SYSTEMS

PRODUCT	PART NO	PACKAGING UNIT	CATEGORY
---------	---------	----------------	----------

FLAMMABLE - CATALYTIC GAS DETECTORS



A 4-20-mA-transmitter for continuous monitoring of flammable gases and vapours in the ambient air to prevent explosive hazards. The gas concentration is converted into a 4-20-ma standard signal which, by means of suitable central controllers, can be used to activate automatic countermeasures and alarm devices.

By opening the enclosure a two digit 7-segment display with two operating keys is accessible to perform menu-controlled one-man-calibration and maintenance.

PEX 3000 - Transmitter			
Draeger PEX 3000 type XTR 0000 Incl. sensor 100% LEL, small housing	8318280	1	G
Draeger PEX 3000 type XTR 0001 Incl. sensor 100% LEL, big housing	8318360	1	G
Draeger PEX 3000 type XTR 0010 Incl. sensor 10% LEL, small housing	8318290	1	G
Draeger PEX 3000 type XTR 0011 Incl. sensor 10% LEL, big housing	8318370	1	G
Draeger PEX 3000 type XTR 0090 Remote transmitter, small housing	8318380	1	G
Draeger PEX 3000 type XTR 0091 Remote transmitter, big housing	8318390	1	G
Catalytic Sensors			
DrägerSensor Ex PR M DQ	6814140	1	G
DrägerSensor Ex HT M DQ	6814145	1	G
DrägerSensor Ex PR NPT DQ	6814150	1	G
Dräger Sensor PR M DD - Spare sensor for Polytron SE Ex PR M ... PEX 3000 (XTR 0000 and XTR 0001). Also sparesensor for Ex-Sensor PR M (6809225) in transmitter PEX 3000 XTR 0000 (8318280) and XTR 0001 (8318360), Polytron SE Ex PR M (6809758) and Polytron SE Ex PR M GB (6811500) and transmitter Polytron Ex (8317517)	6812220	1	G
Dräger Sensor HT M DD - Spare Sensor for Polytron SE Ex HT M DD. Also spare sensor for Ex-Sensor HT M (6810526) in Polytron SE Ex HT M (6810530)	6812390	1	G
Dräger Sensor PR NPT DD - Spare Sensor for Polytron SE Ex PR NPT, Polytron 5xxx and Polytron 8xxx	6812380	1	G
Dräger Sensor Ex LC M (10%LEL) - Spare sensor for Polytron SE Ex LC M ... DD, PEX 3000 (XTR 0010 and XTR 0011). Also spare sensor for Polytron SE Ex LC M (6810486) and Polytron LC M GB (6811495)	6810350	1	G
Dräger Sensor Ex LC NPT	6810675	1	G

FIRE & GAS DETECTION SYSTEMS

PRODUCT	PART NO	PACKAGING UNIT	CATEGORY
Accessories			
Process Adapter for Ex DQ Sensor	6812470	1	G
Process Adapter for Ex LC Sensor	6812465	1	G
Remote calibration adapter DD	6812480	1	G
Remote calibration adapter LC	6812482	1	G
Splash guard	6812510	1	G
Calibration Adapter Viton	6810536	1	G
Gassing Adapter	6806978	1	G
Dust Filter (not suitable for Dräger Sensor Ex LC M)	6810537	1	G
Special Tool PEX 3000	8318376	1	G

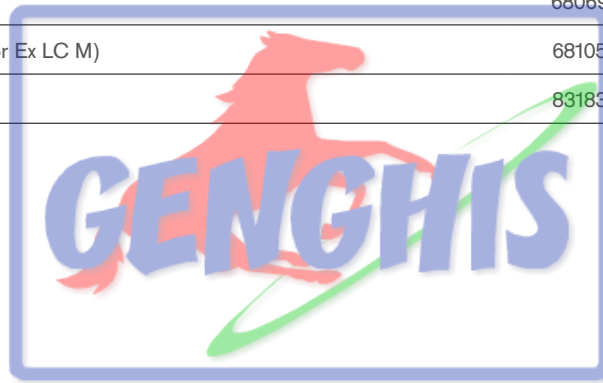

Place You Put Your Faith

FIRE & GAS DETECTION SYSTEMS

PRODUCT	PART NO	PACKAGING UNIT	CATEGORY
---------	---------	----------------	----------



the Dräger Polytron 5200 CAT is a cost-effective explosion proof transmitter for the detection of combustible gas using a catalytic bead sensor. 3 wire 4-20 mA output with relays make it compatible with most control systems. You can choose between explosion proof "d" (USA) or flame proof increased safety "e" version (Europe) and aluminum (A) or stainless steel (S). All stainless steel (S) versions include stainless steel blind plugs. *The docking station (E-Box) is included with every "e" version

Three-wire, 10 to 30 VDC

Non-intrusive calibration using a magnetic wand

3 digit LCD display

4 to 20 mA output. Includes sensor.

Methane (CH₄), Ethylene (C₂H₄), Propane (C₃H₈), Propylene (C₃H₆) etc.

Ammonia (NH₃), Hydrogen (H₂), Acetylene (C₂H₂)

catalytic detector Sensor : 0 - 100% LEL

LC Sensor : 0 - 10 % LEL or PPM (Leak detection)

Includes Sensor

Polytron 5200 (IEC Ex, ATEX Approved)

Transmitter Ex d Versions (Remote versions require Exd Junction boxes)

Some Polytron 5200 models need to be configured using Polytron configurator online, and must accompany all order.

Part number 8344500 is a common configurable part number.

Dräger Polytron 5200 CAT e A*	8344154	1	G
Dräger Polytron 5200 CAT e A relay*	8344155	1	G
Polytron 5200, d A	8344150	1	G
Polytron 5200, d A Relay	8344151	1	G
Polytron 5200, d S	8344152	1	G
Polytron 5200, d S Relay	8344500	1	G
Polytron 5200, LC d A	8344500	1	G
Polytron 5200, LC d A relay	8344500	1	G
Polytron 5200, LC d S	8344500	1	G
Polytron 5200, LC d S relay	8344500	1	G
Junction Box S	4544098	1	G
Junction Box A	4544099	1	G
Accessories			
Magnet W/Key Chain P5000/8000	4544101	1	G
Irda Interface Assy	4544197	1	G
Pipe Mount Kit Px000	4544198	1	G
Duct Mount Kit	6812725	1	G
Process Adapter DD Steel (inline applications)	6812470	1	G
Remote Calibration Adapter DD	6812480	1	G
Remote Calibration Adapter LC	6812482	1	G

FIRE & GAS DETECTION SYSTEMS

PRODUCT	PART NO	PACKAGING UNIT	CATEGORY
Spare Sensors			
DrägerSensor Ex PR M DQ	6814140	1	G
DrägerSensor Ex HT M DQ	6814145	1	G
DrägerSensor Ex PR NPT DQ	6814150	1	G
Dräger Sensor Ex LC M (10%LEL)	6810350	1	G
Dräger Sensor Ex LC NPT	6810675	1	G
Remote Calibration Adapter LC	6812482	1	G



Place You Put Your Faith

FIRE & GAS DETECTION SYSTEMS

PRODUCT	PART NO	PACKAGING UNIT	CATEGORY
---------	---------	----------------	----------



The Polytron 8200 CAT is Dräger's top of the line explosion proof transmitter for the detection combustible gas with a catalytic bead sensor. It comes standard with an analog 3 wire 4-20mA HART output. Relays and fieldbus interface module are optional. You can choose between explosion proof "d" (USA) or flame proof increased safety "e" version (Europe) and aluminum (A) or stainless steel (S).

All stainless steel (S) versions include stainless steel blind plugs.

*The docking station (E-Box) is included with every "e" version. A configurable part number 8344800 is available for some stainless steel and all fieldbus options. Please calculate the total price by adding the options below to the base price.

Three-wire, 10 to 30 VDC
 Non-intrusive calibration using a magnetic wand
 3 digit LCD display
 4 to 20 mA output
 Methane (CH₄), Ethylene (C₂H₄), Propane (C₃H₈), Propylene (C₃H₆) etc.
 Ammonia (NH₃), Hydrogen (H₂), Acetylene (C₂H₂)
 Cat Sensor : 0 - 100% LEL
 LC Sensor : 0 - 10 % LEL or PPM (Leak detection)
 Ammonia : 0 - 10,000/30,000 PPM (Alarm 2000/4000 PPM)

Polytron 8200 (IEC Ex, ATEX Approved) with HART, SIL 2 (IEC61508)

Transmitter Ex d Versions (Remote versions require Exd Junction boxes)

Some Polytron 8200 models need to be configured using Polytron configurator online, and must accompany all order.
 Part number 8344800 is a common configurable part number.

Polytron 8200 d A 4-20/HART	8344439	1	G
Polytron 8200 d A 4-20/HART relay	8344440	1	G
Polytron 8200 d S 4-20/HART	8344448	1	G
Polytron 8200 d S 4-20/HART relay	8344449	1	G
Polytron 8200 LC d A 4-20/HART	8344800	1	G
Polytron 8200 LC d A 4-20/HART relay	8344800	1	G
Polytron 8200 LC d S 4-20/HART	8344800	1	G
Polytron 8200 LC d S 4-20/HART relay	8344800	1	G
Junction Box S	4544098	1	G
Junction Box A	4544099	1	G

FIRE & GAS DETECTION SYSTEMS

PRODUCT	PART NO	PACKAGING UNIT	CATEGORY
Some Polytron 8200 models need to be configured using Polytron configurator online, and must accompany all order. Part number 8344800 is a common configurable part number. Transmitter Ex e Versions (Require appropriate E-Box for complete set)			
Polytron 8200 DD e A 4-20/HART	8344457	1	G
Polytron 8200 DD e A 4-20/HART relay	8344458	1	G
Polytron 8200 DD e S 4-20/HART	8344800	1	G
Polytron 8200 DD e S 4-20/HART relay	8344800	1	G
Polytron 8200 LC e A 4-20/HART	8344800	1	G
Polytron 8200 LC e A 4-20/HART relay	8344800	1	G
Polytron 8200 LC e S 4-20/HART	8344800	1	G
Polytron 8200 LC e S 4-20/HART relay	8344800	1	G
E-box Power only version (Includes 1 cable gland) / docking station	6812420	1	G
E-box Power and Relay version (Includes 2 cable glands) / Docking station	6812275	1	G
Accessories			
Magnet W/Key Chain P5000/8000	4544101	1	G
Irda Interface Assy	4544197	1	G
Pipe Mount Kit Px000	4544198	1	G
Duct Mount Kit	6812725	1	G
Process Adapter DD Steel (inline applications)	6812470	1	G
Remote Calibration Adapter DD	6812480	1	G
Remote Calibration Adapter LC	6812482	1	G
Spare Sensors			
Dräger Sensor PR M	6812220	1	G
Dräger Sensor HT M	6812390	1	G
Dräger Sensor PR NPT	6812380	1	G
Dräger Sensor Ex LC M (10%LEL)	6810350	1	G
Dräger Sensor Ex LC NPT	6810675	1	G

FIRE & GAS DETECTION SYSTEMS

PRODUCT	PART NO	PACKAGING UNIT	CATEGORY
---------	---------	----------------	----------



Dräger Polytron SE EX HT M DD

The sensing head Polytron SE Ex HT M DD (HT = High Temperature) is intended to be used at ambient temperatures up to 150 °C. This sensing head is preferably used in applications where extremely high temperatures can occur, especially for leak detection in the direct vicinity of gas turbines. The temperature resistant terminals are housed in a robust galvanized cast iron enclosure.

Dräger Polytron SE Ex HT M DD (High Temperature Catalytic Sensor)

Polytron SE EX HT M Cast Iron Housing	6812720	1	G
Remote Calibration Adapter	6812480	1	G



Catalytic bead sensors are housing heated beads (Pellistors) which catalytically oxidize flammable gases and vapours causing their temperature to rise by the additional heat of reaction. The pellistor's resistance increases with temperature and is proportional to the gas concentration.

Spare Catalytic Sensors for SE Ex, PEX 3000 & HT Sensors

Dräger Sensor PR M DD Spare sensor for Polytron SE Ex PR M, DD, PEX 3000 (XTR 0000 and XTR 0001). Also replacement sensor for Ex-Sensor PR M (6809225) in transmitter PEX 3000 XTR 0000 (8318280) and XTR 0001 (8318360), Polytron SE Ex PR M (6809758) and Polytron SE Ex PR M GB (6811500) and transmitter Polytron Ex (8317517)	6812220	1	G
Dräger Sensor HT M DD Replacement Sensor for Polytron SE Ex HT M DD. Also spare sensor for Ex-Sensor HT M (6810526) in Polytron SE Ex HT M (6810530)	6812390	1	G
Dräger Sensor PR NPT DD Replacement Sensor for Polytron SE Ex PR NPT DD, Polytron 5200 and Polytron 8200	6812380	1	G
Dräger Sensor Ex LC M (10%LEL) Replacement sensor for Polytron SE Ex LC M ... DD, PEX 3000 (XTR 0010 and XTR 0011). Also spare sensor for Polytron SE Ex LC M (6810486) and Polytron LC M GB (6811495)	6810350	1	G
Dräger Sensor Ex LC NPT	6810675	1	G

FIRE & GAS DETECTION SYSTEMS

PRODUCT	PART NO	PACKAGING UNIT	CATEGORY
---------	---------	----------------	----------

DRÄGER REGARD 7000 - CONTROL SYSTEM



The Dräger REGARD 7000 is a modular and therefore highly expandable analysis system for monitoring various gases and vapours. Suitable for gas warning systems with various levels of complexity and numbers of transmitters, the Dräger REGARD 7000 also features exceptional reliability and efficiency. Another benefit is the backward compatibility with the REGARD.

Digital Input Module Required – for connecting smoke, heat, relay inputs, Manual Call Points (MCP), Break Glass etc.

Cabinet/Enclosures, Wiring are not included and is available upon request.

Dräger REGARD 7000			
REGARD 7000 Add-On System Configuration	8327841		
REGARD 7000 Advanced Dashboard 6 RU configurable (Rack Mount)	8326850	1	
REGARD 7000 Advanced Dashboard PM configurable (Panel Mount)	8326860	1	
REGARD 7000 Add-On Component Report	8324024	1	
REGARD 7000 Add-On Library	8324023	1	
REGARD 7000 Add-On System Documentation	8324025	1	
Dashboards Basic Units			
REGARD 7000 Std Dashboard 3RU Basic Unit	8328250		
REGARD 7000 Adv Dashboard 6RU Basic Unit	8328255		
REGARD 7000 Adv Dashboard PM Basic Unit	8328260		
Input/output (I/O) Modules & Accessories (Input, Relays & Output modules require Terminals)			
REGARD 7000 Docking Station 8-Slot	8322286	1	
REGARD 7000 Docking Station 4-Slot	8322320	1	
REGARD 7000 Slot Cover	8323812	1	
REGARD 7000 4-20 mA Input Module c/w HART®	8327250	1	
REGARD 7000 4 to 20 mA Input Module	8324001	1	
REGARD 7000 Relay Module 24 V DC	8323250	1	
REGARD 7000 Relay Module 240V AC	8324010	1	
REGARD 7000 Relay Module 24 V DC complex	8324874	1	
REGARD 7000 Relay Module 240V AC complex	8324875	1	
REGARD 7000 Terminal Block 2 pole	8324871	1	
REGARD 7000 Modbus Master Module	8328200	1	

FIRE & GAS DETECTION SYSTEMS

PRODUCT	PART NO	PACKAGING UNIT	CATEGORY
REGARD 7000 PC configuration software (Available via download);	8327842	1	I
REGARD 7000 PC-Software Key	8327253	1	I
REGARD 7000 Retaining bracket set (7x)	8327257	1	I
REGARD 7000 Terminal Block 16 poles (for digital inputs only)	8324017	1	I
REGARD 7000 Terminal Block 24 pole AC (for AC relay modules)	8324016	1	I
REGARD 7000 Terminal Block 24 pole DC (for 4-20mA inputs & DC Relay outputs)	8324020	1	I
REGARD 7000 Modbus RTU Gateway (output) Kit Incl.uding terminals	8324872	1	I
REGARD 7000 Terminal Block 2 pole (for Modbus) spare	8324871	1	I
REGARD 7000 Bridge Module	8324870	1	I
REGARD 7000 Long Distance Gateway Set I	8323815	1	I



Place You Put Your Faith

FIRE & GAS DETECTION SYSTEMS

PRODUCT	PART NO	PACKAGING UNIT	CATEGORY
---------	---------	----------------	----------

CONTROL UNITS



Dräger REGARD 2400 and 2410 are flexible small control units for detection of toxic gases and oxygen as well as combustible gases and vapours. Combined with the Dräger transmitters or sensing heads Dräger REGARD 2400 or 2410 forms a low-maintenance gas detection system for reliable protection.

Dräger REGARD 2400 and 2410		
Dräger REGARD 2410	SC00011	1
Dräger REGARD 2400	SC00014	1
Internal converter module SE Ex Only Dräger REGARD 2400, one required per SE Ex channel	SC00016	1
Configuration set	SC00040	1
Input-Output module	SC00018	1
Relay module	SC00019	1
REGARD 2400 Converter module RS232/485 For Dräger RVP2400, internal	SC00042	1
REGARD 2410 Converter module RS232/485 For Dräger RVP 2410, external - not usable for REGARD 2400	SC00041	1
RVP 2400	SC00043	1
RVP 2400 Data logger	SC00044	1
RVP 2400 WEB Including data logger	SC00045	1
Additional communication interface		
RVP 2400 interface card RS485/232	SD13433	1
RVP 2400 interface card Profibus DP	SD11926	1

FIRE & GAS DETECTION SYSTEMS

PRODUCT	PART NO	PACKAGING UNIT	CATEGORY
---------	---------	----------------	----------



The Dräger REGARD 3900 is a standalone, self-contained control system for the detection of Toxic, Oxygen and Ex hazards. The control system is fully configurable between 1 and 16 channels, depending upon the type and quantity of input/output boards installed. Transmitter input boards for 4 to 20 mA signals can be mixed with relay output boards in the same control system. The robust IP 65 housing allows the control system to be installed in almost any location, excluding hazardous, classified areas¹. At any time, the control system can be upgraded to meet with plant extensions and changes.

Complete assembly excluding power supply		
REGARD 3900 1 + 1 (incl. housing, 1 input board + 1 relay board)	4208810	1
REGARD 3900 1 + 2	4208811	1
REGARD 3900 2 + 0	4208812	1
REGARD 3900 2 + 1	4208813	1
REGARD 3900 2 + 2	4208814	1
REGARD 3900 3 + 0	4208815	1
REGARD 3900 3 + 1	4208816	1
REGARD 3900 4 + 0	4208817	1
Components		
REGARD 3900 (Incl. housing + display)	4208780	1
REGARD 3920 Basic unit (Incl. housing + display)	4208850	1
REGARD 3910 (Display board for mounting into cabinet)	4208830	1
REGARD 3910 ribbon cable (Required for 4208830)	4208750	1
REGARD 3910 Back Plate (For mounting modules into cabinet)	4208831	1
REGARD 3900 / 3910 / 3920 4 to 20 mA input module 4 way	4208782	1
REGARD 3900 / 3910 / 3920 relay module	4208784	1
REGARD 3900 / 3920 mounting bracket	4208796	1
REGARD 3900 / 3910 / 3920 repeat 4 to 20 mA board, 8 outputs	4208797	1
Regard 3900 / 3910 / 3920 Configuration cable (Software for free available on our homepage)	4208785	1
Power supply for DIN rail mounting, 110/230 VAC, 2.5A	4208745	1
Power supply for DIN rail mounting, 110/230 VAC, 5A	4208746	1
Power supply for DIN rail mounting, 110/230 VAC, 10A	4208747	1
REGARD 3900 ABS Junction Box (Same size, for e.g. safety barriers, relays ...)	4208751	1

FIRE & GAS DETECTION SYSTEMS

PRODUCT	PART NO	PACKAGING UNIT	CATEGORY
Visualisation Panel			
RVP 3900	SC00080	1	
RVP 3900 Datalogger	SC00081	1	
RVP 3900 WEB (Including Datalogger)	SC00082	1	
REGARD 3900 / 3910 / 3920 modbus gateway	SC00083	1	
REGARD 3900 / 3910 / 3920 profibus gateway	AG01100	1	
REGARD 3900 / 3910 / 3920 modbus TCPIP gateway	SD13037	1	
REGARD 3900 / 3920 gateway cable	SC00084	1	
REGARD 3910 gateway cable (Only without display board)	SC00085	1	



The Dräger Regard-1 is a standalone, self contained single channel control system for the detection of Toxic, Oxygen and Ex hazards. The control system is fully configurable for a single input from either a 4 to 20 mA transmitter or a Dräger Polytron SE Ex measuring head. The robust IP 65 housing allows the control system to be installed in almost any location, excluding hazardous, classified areas. Developed with an innovative modular design ensures that the entire system is suitable for the most stringent of budgets.

Place You Put Your Faith

Regard 1			
Regard 1, 5mA control unit complete	4208585	1	G

FIRE & GAS DETECTION SYSTEMS

PRODUCT	PART NO	PACKAGING UNIT	CATEGORY
---------	---------	----------------	----------

SAFE AREA DETECTORS (TOXIC/FLAMMABLE) & CONTROLLERS



The VarioGard is a state of the art system for continuous measurement and monitoring of gas concentrations in the environment. Up to 100 transmitters or modules can be connected via a digital bus to the central unit. The system is extremely flexible and can be configured by software to meet the needs of various applications. Detectors can be wired in series, star or mesh network.

Requires: Central Unit (max of 25 detectors) Includes five relays + Repeater (> 25 detectors) or Converter (for 4 to 20mA input detectors only)

To connect Analog (4 to 20mA) transmitters or digital inputs from Temperature transmitters with VarioGard controller, use convertor module.

VarioGard Central Control Unit			
Transmitter			
VarioGard central unit, English, wall mount. 230 V AC	8315350	1	G
VarioGard central unit, English, cabinet vers. 230 V AC	8315360	1	G
Modules			
VarioGard battery module 28 VDC, 7Ah w/o battery	8315178	1	G
Lead battery-set VarioGard (battery for above)	8315569	1	G
VarioGard Relay module (five freely programmable relays)	8315238	1	G
VarioGard Converter module (convert 4 to 20mA to Bus)	8315226	1	G
VarioGard Repeater	8317146	1	G
Wallmount.Housing VarioGard	8315647	1	G
VarioGard Modbus Gateway	8324834	1	G
Accessories			
Cable gland M 20 x 1.5, 10 each	8315420	1	G
Calibration adapter VarioGard 3x00	8322015	1	G
Software-Set VarioGard 3x00 (Incl. USB adapter)	8322016	1	G
Magnetic wand	4543428	1	G
Operating Manual VarioGard	9033185	1	G

FIRE & GAS DETECTION SYSTEMS

PRODUCT	PART NO	PACKAGING UNIT	CATEGORY
---------	---------	----------------	----------

TRANSMITTERS



Dräger VarioGard 3x00 Transmitter with integrated sensor for gas detection in ambient air. A simple digital gas warning system for non industrial gas detection systems.

The VarioGard is to be used only in safe area applications within the temperature range specified. VarioGard requires Dräger VarioGard Central Control Unit. Service can only be performed by Dräger Service unless the customer purchases a complete licensed copy of the software (for use in one PC only)

VarioGard 3x00 - (Digital Bus Type Gas Detector)			
Bus-Transmitter (Plastic Housing)			
VarioGard 3000 EC CO PL (Range: 0 to 300 ppm)	8322050	1	G
VarioGard 3000 EC NO2 PL (Range: 0 to 20 ppm)	8322051	1	G
VarioGard 3000 EC NH3 PL (Range: 0 to 1200 ppm)	8322052	1	G
VarioGard 3000 EC O2 PL (Range: 0 to 25% Vol.)	8322053	1	G
VarioGard 3000 EC NO PL (Range: 0 to 50 ppm)	8322054	1	G
Bus-Transmitter (Aluminium Housing)			
VarioGard 3000 EC CO AL (Range: 0 to 300 ppm)	8322055	1	G
VarioGard 3000 EC NO2 AL (Range: 0 to 20 ppm)	8322056	1	G
VarioGard 3000 EC NH3 AL (Range: 0 to 1200 ppm)	8322057	1	G
VarioGard 3000 EC O2 AL (Range: 0 to 25% Vol.)	8322058	1	G
VarioGard 3000 EC NO AL (Range: 0 to 50 ppm)	8322059	1	G
VarioGard 3200 CAT AL (alu-housing)	8322787	1	G
VarioGard 3320 IR CO2 AL (Range: 0 to 5% Vol.)	8323628	1	G
VarioGard 3300 IR Ex AL (Range: 0 to 100% LEL CH4 /LPG)	8323627	1	G



Dräger VarioGard 23X0 IR Transmitter with integrated sensor for gas detection Methane/LPG or CO₂ in ambient air. A simple gas detector for light/clean industrial application with 4 to 20mA output. Maintenance can be performed using a magnetic wand.

The VarioGard is to be used only in safe area applications within the temperature range specified. VarioGard analogue detectors can be interfaced to Dräger or third party controllers. No built-in horn.

VarioGard 23x0 IR - (Analogue Type IR Gas Detector for Safe Area)			
Analogue-Transmitter (Aluminium Housing)			
VarioGard 2300 IR Ex AL (alu-housing) for detection of LPG/Methane Range: 0 - 100% LEL	8324832	1	G
VarioGard 2320 IR CO2 AL (alu-housing) Range: 0 - 5% Vol.	8324833	1	G

Dräger Region South East Europe | Rev: 0 | Subject to modification! | www.draeger.com

FIRE & GAS DETECTION SYSTEMS

PRODUCT	PART NO	PACKAGING UNIT	CATEGORY
---------	---------	----------------	----------



The Dräger Polytron 2000 transmitter is a cost optimized general purpose transmitter for continuous monitoring of toxic gases and oxygen in ambient air. The compact housing consists of two parts: the "Polytron docking station" and the "Polytron 2000" device. The high measuring Performance is based on the new Dräger sensor MEC which needs to be adapted to each Polytron 2000 with a MEC-key.

Requires: Polytron 2000 + Docking Station Polytron 2000 + Sensor + MEC Key

Polytron 2000 - (Analogue Type Gas Detector for Toxic gases -Safe Area only)			
Dräger Polytron 2000 NH3 HC 1000 ppm For use with DrägerSensor NH3 HC 6809645	8323741	1	G
Dräger Polytron 2000 O2 25 Vol.-%	8323745		
Dräger Polytron 2000 CO 1000 PPM	8323681	1	G
Dräger Polytron 2000 CO 300 PPM	8323684	1	G
Dräger Polytron 2000 H2S LC 20 PPM	8323685	1	G
Dräger Polytron 2000 H2S LC 100 PPM	8323688	1	G
Dräger Polytron 2000 NH3 LC 200 PPM	8323689	1	G
Dräger Polytron 2000 O2 LS 25 Vol%	8323747	1	G
Dräger Polytron 2000 Cl2 10 PPM	8323750	1	G
Docking Station Polytron 2000	8323677	1	G
MEC-Key	6812695	1	G
Sensors			
Dräger Sensor MEC CO	6812730	1	G
Dräger Sensor MEC H2S	6812735	1	G
Dräger Sensor MEC NH3	6812750	1	G
Dräger Sensor MEC O2	6812740	1	G
Dräger Sensor MEC Cl2	6812745	1	G

FIRE & GAS DETECTION SYSTEMS

PRODUCT	PART NO	PACKAGING UNIT	CATEGORY
---------	---------	----------------	----------

CONVERTOR MODULE



PEX 1000 establishes the link between the Polytron SE Ex DD sensing heads and a control unit. PEX 1000 convertor module installed in a safe area convert mV signal from the catalytic sensor to a 4-20-mA Signal, and by means of suitable central controllers, can be used to activate automatic countermeasures and alarm devices. A two digit 7-segment display with two operating keys is accessible to perform menu-controlled one-man-calibration and maintenance.

PEX 1000 requires sensor Polytron SE Ex which may be installed in hazardous areas.

PEX 1000 - Convertor Module			
Draeger PEX 1000	8324835	1	G
Sensing Heads			
Sensing head Polytron SE Ex PR M2 DD Midsize standard housing	6812710	1	G
Sensing head Polytron SE Ex PR NPT1 DD Flameproof metal housing	6812800	1	G

Place You Put Your Faith

FIRE & GAS DETECTION SYSTEMS

PRODUCT	PART NO	PACKAGING UNIT	CATEGORY
---------	---------	----------------	----------

DRÄGER POINTGARD 2200



The Dräger PointGard 2200 is a self-contained gas detection system for the continuous area monitoring of combustible gases in ambient air. PointGard 2200's rugged, water resistant enclosure comes complete with a horn and strobes plus a built in power supply.

The standard version has amber and red strobes, while the green version has a green steady status light and a red strobe.

Remote version requires XP junction box and sensor or Polytron SE Ex.

AC: 120/240V AC Power Supply

DC: 8-30V DC Converter

*AC Power cable with plug is optional..

Gas Monitors		
Dräger PointGard 2200 CAT AC (w/ sensor)	8326421	1
Dräger PointGard 2200 CAT AC w/ Green Status Light	8326427	1
Dräger PointGard 2200 CAT AC Remote (w/o sensor)	8326422	1
Dräger PointGard 2200 CAT AC Remote w/ Green Status Light	8326468	1
Dräger PointGard 2200 CAT DC (w/ sensor)	8326424	1
Dräger PointGard 2200 CAT DC Remote (w/o sensor)	8326425	1
Remote Sensor		
DrägerSensor PR NPT DQ	6814150	1
Polytron SE Ex PR M1 DQ (small standard housing)	6812711	1
Remote XP Junction Box 316L St. Steel (includes 8327024)	4544098	1
Remote XP Junction Box Aluminum (includes 8327024)	4544099	1
Remote Sensor Plug and Play Wiring Kit for XP Junction Box	8327024	1
Remote Sensor		
Mounting Brackets (set of 4 w/ screws)	8326497	1
Splash Guard	6812510	1
Process adapter for Ex DQ Sensor	6812470	1
Calibration Adapter V (black rubber)	6810536	1
EW 3 power cable 2.5 m PointGard 2000, BR*	8326448	1
EW 3 power cable 2.5 m PointGard 2000, EU*	8326449	1
EW 3 power cable 2.5 m PointGard 2000, UK*	8326450	1
EW 3 power cable 2.5 m PointGard 2000, US*	8326451	1
EW 3 power cable 2.5 m PointGard 2000, AUS*	8326452	1
Dräger PolySoft Configuration Software	8323405	1
IR Connection Kit (requires PolySoft)	4544197	1

FIRE & GAS DETECTION SYSTEMS

PRODUCT	PART NO	PACKAGING UNIT	CATEGORY
---------	---------	----------------	----------

DRÄGER PULSAR 7000 SERIES



The new Dräger Pulsar 7000 series is an ex-protected stationary gas detection system with an open measuring path to monitor hydrocarbons in gas and vapour.

The extremely short reaction time of the sensor and its robust design makes the Pulsar 7000 series to a reliable solution for your challenges for protecting people and plant.

Explanations:

Tx S(hort) Range: 4 to 60m

Tx L(ong) Range: 30 to 200m

Rx S(hort) Range: 4 to 120m

Rx L(ong) Range: 100 to 200m

Dräger Pulsar 7700: Receiver factory calibrated on Methane and Propane

Dräger Pulsar 7900: Receiver factory calibrated on Ethylene

JB Ex e: Black PE reinforced junction box (4x M20)

JB Ex e SS: Silver stainless steel junction box (4x M25)

Transmitter and Receiver
ATEX / IECEx

STANDARD

Dräger Pulsar 7000 Tx S Range JB Ex e	6851700	1
Dräger Pulsar 7000 Tx L Range JB Ex e	6851701	1
Dräger Pulsar 7700 Rx S Range JB Ex e	6851702	1
Dräger Pulsar 7700 Rx L Range JB Ex e	6851703	1
Dräger Pulsar 7900 Rx S Range JB Ex e	6851704	1
Dräger Pulsar 7000 Tx S Range JB Ex e Ho	6851706	1
Dräger Pulsar 7000 Tx L Range JB Ex e Ho	6851707	1
Dräger Pulsar 7700 Rx S Range JB Ex e Ho	6851708	1
Dräger Pulsar 7900 Rx S Range JB Ex e Ho	6851709	1
DUCT MOUNT		
Dräger Pulsar 7700 Duct Mount JB Ex e	6851716	1
Dräger Pulsar 7000 Duct Mount Tx JB Ex e	6851530	1
Dräger Pulsar 7700 Duct Mount Rx JB Ex e	6851531	1

FIRE & GAS DETECTION SYSTEMS

PRODUCT	PART NO	PACKAGING UNIT	CATEGORY
HEAVY DUTY / OFFSHORE			
Dräger Pulsar 7000 Tx S Range JB Ex e SS	6851718	1	
Dräger Pulsar 7000 Tx L Range JB Ex e SS	6851719	1	
Dräger Pulsar 7700 Rx S Range JB Ex e SS	6851720	1	
Dräger Pulsar 7700 Rx L Range JB Ex e SS	6851721	1	
Dräger Pulsar 7900 Rx S Range JB Ex e SS	6851712	1	
UL			
Dräger Pulsar 7000 Tx S Range UL	6851728	1	
Dräger Pulsar 7000 Tx L Range UL	6851729	1	
Dräger Pulsar 7900 Rx S Range UL	6851732	1	
Dräger Pulsar 7700 Rx S Range UL	6851733	1	
Dräger Pulsar 7700 Rx L Range UL	6851734	1	
DUCT MOUNT			
Dräger Pulsar 7700 Duct Mount UL	6851739	1	
Dräger Pulsar 7000 Duct Mount Tx UL	6851730	1	
Dräger Pulsar 7700 Duct Mount Rx UL	6851731	1	
Accessories			
MOUNTING PARTS			
2" / 50mm Pipe mount kit	2307003	1	
6" / 150mm Pipe mount kit	2350302	1	
Pulsar 7000 duct wall mounting plate kit	2350450	1	
COMMISSIONING and MAINTENANCE			
PIA, single unit	6851565	1	
Alignment kit for Pulsar 7700 w/ PIA	6851630	1	
Alignment kit for Pulsar 7900 w/ PIA	6851631	1	
Alignment kit for Pulsar 7700 Duct Mount w/ PIA	6851632	1	
Alignment kit with HHT Test cards and ball driver with case for standard variant	2350325	1	
Alignment kit with HHT Test cards and ball driver with case for Ethylene variant	2350519	1	
Gas test sheets Ethylene, spares for p/n 2350519	2350520	1	
Gas test sheets, spares for p/n 2350325	2350521	1	
Gas test sheets, Dräger Pulsar 7700 Duct Mount	2350451	1	
Attenuator plate AP800	2350339	1	
Lens cleaning fluid	2350291	1	
Pulsar alignment telescope	2350505	1	

Dräger Region South East Europe | Rev: 0 | Subject to modification! | www.draeger.com

Place You Put Your Faith

PORTABLE
GAS DETECTIONPERSONAL
PROTECTION
EQUIPMENTDRUG & ALCOHOL
DETECTION

MASKS & FILTERS

FIRE & GAS
DETECTION
SYSTEMSENGINEERED
SOLUTIONSSERVICE,
TRAINING & RENTALDIVING
TECHNOLOGY

FIRE & GAS DETECTION SYSTEMS

PRODUCT	PART NO	PACKAGING UNIT	CATEGORY
COMMUNICATION			
Remote junction box kit	2350322	1	
AI500 digital interface	2350306	1	
Adapter AI500 to HHT or PC	2350326	1	
Pulsar PC cable	2307021	1	
CALIBRATION KITS			
Gas cell kit, single pass (Propane)	2350514	1	
Gas cell kit, single pass (Methane)	2350516	1	
Gas cell kit, single pass (Methane and Propane)	2350518	1	



Place You Put Your Faith

FIRE & GAS DETECTION SYSTEMS

PRODUCT	PART NO	PACKAGING UNIT	CATEGORY
---------	---------	----------------	----------

OPEN PATH TOXIC GAS DETECTORS



The latest SafEye Quasar open path UV detection technology includes the 950 and the 960 series. The Quasar 950 models detect toxic Hydrogen Sulfide & Sulphur Dioxide gas and the Quasar 960 models detect toxic Ammonia gas, both with path lengths of up to 263ft (80m). The Quasar 950 and 960 models can be tailored to protect your personnel and high-risk installations.

Please do not discount without prior permission

Spectrex Quasar UV Open Path Gas detector.			
SafEye 951/961 Tx (5-20m) QTU-C-111 M25	6813490	1	
SafEye 951/961 Tx (5-20m) QTU-C-112 3/4" NPT	6813491	1	
SafEye 952/962 Tx (15-40m) QTU-C-211 M25	6813492	1	
SafEye 952/962 Tx (15-40m) QTU-C-212 3/4" NPT	6813493	1	
SafEye 953/963 Tx (35-60m) QTU-C-311 M25	6813494	1	
SafEye 953/963 Tx (35-60m) QTU-C-312 3/4" NPT	6813495	1	
SafEye 950 (H2S) Rx (5-60m) QRU-C-111 M25	6813496	1	
SafEye 950 (H2S) Rx (5-60m) QRU-C-112 3/4" NPT	6813497	1	
SafEye 960 (NH3) Rx (5-60m) QRU-C-211 M25	6813498	1	
SafEye 960 (NH3) Rx (5-60m) QRU-C-212 3/4" NPT	6813499	1	
Tilt mount SafEye 9xx Series	6813501	1	
Commissioning Kit SafEye 950 (H2S)	6813502	1	
Commissioning Kit SafEye 960 (NH3)	6813503	1	
Functional check Filter H2S	6813814	1	
Functional check Filter NH3	6813815	1	
Magnetic Mode Selector	6813816	1	
HART Hand-Held Diagnostic Kit (Ex)	6813505	1	
Mini Laptop Diagnostic Kit (Non-Ex)	6813319	1	
HART Hand-Held Harness Kit	6813506	1	
USB / RS485 converter kit , Incl. SW	6813507	1	
SafEye 9xx connector cable (Non-Ex)	6813508	1	
Pole Mount (U-Bolt) 5" - (SS)	6813509	1	
Pole Mount (U-Bolt) 3" - (SS)	6813621	1	
SafEye Sunshade (SS)	6813510	1	

FIRE & GAS DETECTION SYSTEMS

PRODUCT	PART NO	PACKAGING UNIT	CATEGORY
---------	---------	----------------	----------

DRÄGER FLAME 3000



Dräger Flame 3000 is an imaging based explosion proof w. This multi-channel IR visual flame detection system uses digital signal processing and advanced algorithms to process and interpret flame characteristics. This principle offers an extended field of view and fewer false alarms compared to conventional flame detectors.

Aluminium housing		
Dräger Flame 3000 1 x M25, aluminium	4209460	1
Dräger Flame 3000 2 x M25, aluminium	4209461	1
Dräger Flame 3000 1 x M20, aluminium	4209462	1
Dräger Flame 3000 2 x M20, aluminium	4209463	1
Dräger Flame 3000 1 x 3/4" NPT, aluminium	4209464	1
Dräger Flame 3000 2 x 3/4" NPT, aluminium	4209465	1
Dräger Flame 3000 1 x 1/2" NPT, aluminium	4209476	1
Dräger Flame 3000 2 x 1/2" NPT, aluminium	4209467	1
Stainless steel housing		
Dräger Flame 3000 1 x M25, stainless steel	4209468	1
Dräger Flame 3000 2 x M25, stainless steel	4209469	1
Dräger Flame 3000 2 x M25, stainless steel	4209470	1
Dräger Flame 3000 2 x M20, stainless steel	4209471	1
Dräger Flame 3000 1 x 3/4" NPT, stainless steel	4209477	1
Dräger Flame 3000 2 x 3/4" NPT, stainless steel	4209478	1
Dräger Flame 3000 1 x 1/2" NPT, stainless steel	4209474	1
Dräger Flame 3000 2 x 1/2" NPT, stainless steel	4209475	1
Accessories		
Dräger Flame Simulator FS-5000	4209307	1

FIRE & GAS DETECTION SYSTEMS

PRODUCT	PART NO	PACKAGING UNIT	CATEGORY
Cable Gland (ATEX)			
For unarmoured cable only with cable diameter 7,2...11,7 mm			
M20, brass	AG01093	1	
M20, stainless steel	AG01094	1	
For armoured cable with inner cable diameter 6,7...14 mm and outer sheath 12...17,6 mm			
M20, brass	AG01091	1	
M20, stainless steel	AG01092	1	
For unarmoured cable only with cable diameter 9,4...14,0 mm			
3/4" NPT, brass	AG00570	1	
3/4" NPT, stainless steel	SD11914	1	
For armoured cable only with cable diameter 15,5...21,1 mm			
3/4" NPT, brass	AG06178	1	
3/4" NPT, stainless steel	AG06179	1	

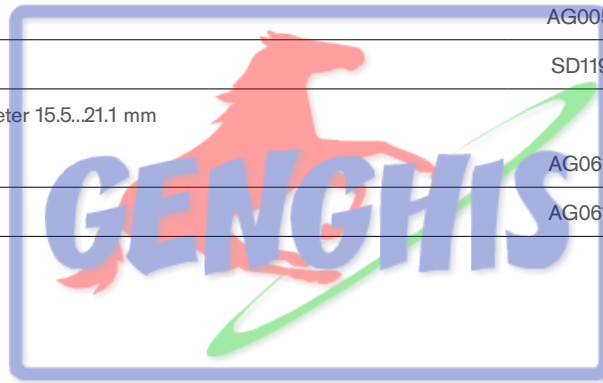

Place You Put Your Faith

FIRE & GAS DETECTION SYSTEMS

PRODUCT	PART NO	PACKAGING UNIT	CATEGORY
---------	---------	----------------	----------

DRÄGER FLAME 5000 (CCTV)



The Dräger Flame 5000 is an explosion proof colour imaging based flame detector. Each detector operates standalone and incorporates, within a single unit, an integrated CCTV system; digital signal processing and software algorithms to process live video image and interpret the characteristics of a flame.

Flame 3000 Visual Flame Detector			
Aluminium Housing			
Dräger Flame 5000, 1 x M20, 4-20mA, PAL	4209308	1	
Dräger Flame 5000, 1 x M20, 4-20mA, NTSC	4209348	1	
Dräger Flame 5000, 1 x M20, Relay, PAL	4209349	1	
Dräger Flame 5000, 1 x M20, Relay, NTSC	4209309	1	
Dräger Flame 5000, 1 x M25, 4-20mA, PAL	4209333	1	
Dräger Flame 5000, 1 x M25, 4-20mA, NTSC	4209352	1	
Dräger Flame 5000, 1 x M25, Relay, PAL	4209353	1	
Dräger Flame 5000, 1 x M25, Relay, NTSC	4209334	1	
Dräger Flame 5000, 1 x 3/4" NPT, 4-20mA, PAL	4209311	1	
Dräger Flame 5000, 1 x 3/4" NPT, 4-20mA, NTSC	4209350	1	
Dräger Flame 5000, 1 x 3/4" NPT, Relay, PAL	4209351	1	
Dräger Flame 5000, 1 x 3/4" NPT, Relay, NTSC	4209310		
Aluminium Housing			
Dräger Flame 5000, 1 x M20, 4-20mA, PAL	4209320	1	
Dräger Flame 5000, 1 x M20, 4-20mA, NTSC	4209354	1	
Dräger Flame 5000, 1 x M20, Relay, PAL	4209355	1	
Dräger Flame 5000, 1 x M20, Relay, NTSC	4209321	1	
Dräger Flame 5000, 1 x M25, 4-20mA, PAL	4209335	1	
Dräger Flame 5000, 1 x M25, 4-20mA, NTSC	4209358	1	
Dräger Flame 5000, 1 x M25, Relay, PAL	4209359	1	
Dräger Flame 5000, 1 x M25, Relay, NTSC	4209336	1	

FIRE & GAS DETECTION SYSTEMS

PRODUCT	PART NO	PACKAGING UNIT	CATEGORY
Dräger Flame 5000, 1 x 3/4" NPT, 4-20mA, PAL	4209323	1	
Dräger Flame 5000, 1 x 3/4" NPT, 4-20mA, NTSC	4209356	1	
Dräger Flame 5000, 1 x 3/4" NPT, Relay, PAL	4209357	1	
Dräger Flame 5000, 1 x 3/4" NPT, Relay, NTSC	4209322	1	
Accessories			
Dräger Flame Simulator FS-5000	4209307	1	
Balanced line to BNC videoconverter (4 channel)	4209327	1	
Passive transceiver 2 wire / BNC	AG01536	1	
Passive transceiver 2 wire / BNC (galvanically isolated)	AG01535	1	
Cable Gland (ATEX)			
For unarmoured cable only with cable diameter 7,2...11,7 mm			
M20, brass	AG01093	1	
M20, stainless steel	AG01094	1	
For armoured cable with inner cable diameter 6,7...14 mm and outer sheath 12...17,6 mm			
M20, brass	AG01091	1	
M20, stainless steel	AG01092	1	
For unarmoured cable only with cable diameter 9,4...14,0 mm			
3/4" NPT, brass	AG00570	1	
3/4" NPT, stainless steel	SD11914	1	
For armoured cable only with cable diameter 15,5...21,1 mm			
3/4" NPT, brass	AG06178	1	
3/4" NPT, stainless steel	AG06179	1	

FIRE & GAS DETECTION SYSTEMS

PRODUCT	PART NO	PACKAGING UNIT	CATEGORY
---------	---------	----------------	----------

DRÄGER FLAME 2XX0



The new Dräger Flame 2xx0 series flame detectors provide the most comprehensive protection against hydrocarbon-based fuel and gas fires, hydroxyl and hydrogen fires, as well as metal and inorganic fires. The detectors provide early warning of fires at long distances with high immunity to false alarms. The new 2xx0 series are the highest performance, most cost-effective flame detectors currently on the market. New features include a stainless steel housing with a heated window, to eliminate condensation and icing; hart capabilities for digital communications; lower power requirements; and a compact, lightweight but highly durable and weather resistant design.

Detector		
ATEX/IECEx (stainless steel)		
Dräger Flame 2500 (IR3-111SC)	6813910	1
Dräger Flame 2500 (IR3-112SC)	6813911	1
Dräger Flame 2500 (IR3-211SC)	6813912	1
Dräger Flame 2500 (IR3-212SC)	6813913	1
Dräger Flame 2500 (IR3-221SC)	6813914	1
Dräger Flame 2500 (IR3-311SC)	6813915	1
Dräger Flame 2570 (UFI-211SC)	6814010	1
Dräger Flame 2570 (UFI-212SC)	6814011	1
Dräger Flame 2700 (M-111SC)	6813916	1
Dräger Flame 2700 (M-211SC)	6813917	1
Dräger Flame 2700 (M-311SC)	6813918	1
Dräger Flame 2000 (R-111SC)	6813919	1
Dräger Flame 2000 (R-211SC)	6813920	1
Dräger Flame 2000 (R-222SC)	6814158	1
Dräger Flame 2000 (R-311SC)	6813921	1
Dräger Flame 2100 (UB-111SC)	6813922	1
Dräger Flame 2100 (UB-211SC)	6813923	1
Dräger Flame 2100 (UB-311SC)	6813924	1
Dräger Flame 2350 (L4B-111SC)	6813925	1
Dräger Flame 2350 (L4B-211SC)	6813926	1
Dräger Flame 2350 (L4B-212SC)	6813927	1

Dräger Region South East Europe | Rev: 0 | Subject to modification! | www.draeger.com

FIRE & GAS DETECTION SYSTEMS

PRODUCT	PART NO	PACKAGING UNIT	CATEGORY
Dräger Flame 2350 (L4B-311SC)	6813928	1	
Dräger Flame 2350 (L4B-312SC)	6813929	1	
Dräger Flame 2370 (UFL-111SC)	6813930	1	
Dräger Flame 2370 (UFL-121SC)	6814204	1	
Dräger Flame 2370 (UFL-211SC)	6813931	1	
Dräger Flame 2370 (UFL-212SC)	6813932	1	
Dräger Flame 2370 (UFL-311SC)	6813933	1	
ATEX/IECEx (Aluminium)			
Dräger Flame 2500 (IR3-111AC)	6813934	1	
Dräger Flame 2500 (IR3-211AC)	6813935	1	
Dräger Flame 2500 (IR3-212AC)	6813936	1	
Dräger Flame 2500 (IR3-221AC)	6813937	1	
Dräger Flame 2500 (IR3-311AC)	6813938	1	
Dräger Flame 2500 (IR3-312AC)	6813939	1	
Dräger Flame 2500 (IR3-411AC)	6813940	1	
Dräger Flame 2000 (R-211AC)	6813941	1	
Dräger Flame 2000 (R-311AC)	6813942	1	
Dräger Flame 2100 (UB-211AC)	6813943	1	
Dräger Flame 2100 (UB-311AC)	6813944	1	
Dräger Flame 2350 (L4B-111AC)	6813945	1	
Dräger Flame 2350 (L4B-211AC)	6813946	1	
Dräger Flame 2350 (L4B-212AC)	6813947	1	
Dräger Flame 2350 (L4B-311AC)	6813948	1	
Dräger Flame 2350 (L4B-312AC)	6813949	1	
Dräger Flame 2370 (UFL-111AC)	6813950	1	
Dräger Flame 2370 (UFL-211AC)	6813951	1	
FM/CSA (stainless steel)			
Dräger Flame 2500 (IR3-112SF)	6813952	1	
Dräger Flame 2500 (IR3-212SF)	6813953	1	
Dräger Flame 2500 (IR3-222SF)	6813954	1	
Dräger Flame 2500 (IR3-312SF)	6813955	1	
Dräger Flame 2570 (UFI-212SF)	6814009	1	
Dräger Flame 2700 (M-112SF)	6813956	1	
Dräger Flame 2700 (M-212SF)	6813957	1	
Dräger Flame 2700 (M-222SF)	6813958	1	
Dräger Flame 2700 (M-312SF)	6813959	1	

Dräger Region South East Europe | Rev: 0 | Subject to modification! | www.draeger.com

Place You Put Your Faith

PORTABLE
GAS DETECTION

PERSONAL
PROTECTION
EQUIPMENT

DRUG & ALCOHOL
DETECTION

MASKS & FILTERS

FIRE & GAS
DETECTION
SYSTEMS

ENGINEERED
SOLUTIONS

SERVICE,
TRAINING & RENTAL

DIVING
TECHNOLOGY

FIRE & GAS DETECTION SYSTEMS

PRODUCT	PART NO	PACKAGING UNIT	CATEGORY
Dräger Flame 2000 (R-112SF)	6813960	1	
Dräger Flame 2000 (R-212SF)	6813961	1	
Dräger Flame 2000 (R-312SF)	6813962	1	
Dräger Flame 2100 (UB-112SF)	6813963	1	
Dräger Flame 2100 (UB-212SF)	6813964	1	
Dräger Flame 2100 (UB-312SF)	6813965	1	
Dräger Flame 2350 (L4B-112SF)	6813966	1	
Dräger Flame 2350 (L4B-212SF)	6813967	1	
Dräger Flame 2350 (L4B-312SF)	6813968	1	
Dräger Flame 2370 (UFL-112SF)	6813969	1	
Dräger Flame 2370 (UFL-122SF)	6814203	1	
Dräger Flame 2370 (UFL-212SF)	6813970	1	
Dräger Flame 2370 (UFL-312SF)	6813971	1	
Dräger Flame 2370 (UFL-322SF)	6813972	1	
EAC CU-TR			
Dräger Flame 2700 (M-211SR)	6814160	1	
Dräger Flame 2700 (M-212SR)	6814161	1	
Dräger Flame 2700 (M-222SR)	6814162	1	
Dräger Flame 2570 (UFI-211SR)	6814163	1	
Dräger Flame 2570 (UFI-212SR)	6814164	1	
Dräger Flame 2500 (IR3-212SR)	6814165	1	
Dräger Flame 2500 (IR3-222SR)	6814166	1	
Dräger Flame 2370 (UFL-212SR)	6814167	1	
Dräger Flame 2370 (UFL-322SR)	6814168	1	
Dräger Flame 2350 (L4B-211SR)	6814169	1	
Dräger Flame 2350 (L4B-212SR)	6814170	1	
Dräger Flame 2350 (L4B-222SR)	6814171	1	
Dräger Flame 2100 (UB-212SR)	6814172	1	
Dräger Flame 2500 (IR3-212AR)	6814173	1	
Dräger Flame 2500 (IR3-221AR)	6814174	1	
Dräger Flame 2500 (IR3-411AR)	6814175	1	
Dräger Flame 2370 (UFL-211AR)	6814176	1	
Dräger Flame 2350 (L4B-212AR)	6814177	1	
Dräger Flame 2100 (UB-211AR)	6814178	1	
Dräger Flame 2000 (R-211AR)	6814179	1	
Dräger Flame 2000 (R-212SR)	6814180	1	

Dräger Region South East Europe | Rev: 0 | Subject to modification! | www.draeger.com

Place You Put Your Faith

PORTABLE
GAS DETECTION

PERSONAL
PROTECTION
EQUIPMENT

DRUG & ALCOHOL
DETECTION

MASKS & FILTERS

FIRE & GAS
DETECTION
SYSTEMS

ENGINEERED
SOLUTIONS

SERVICE,
TRAINING & RENTAL

DIVING
TECHNOLOGY

FIRE & GAS DETECTION SYSTEMS

PRODUCT	PART NO	PACKAGING UNIT	CATEGORY
Accessories			
Flame Simulator FS-1100 (IR3)	6813973	1	
Flame Simulator FS-1200 (UV&IR, UV)	6813974	1	
Flame Simulator FS-1300 (IR)	6813975	1	
Flame Simulator FS-1400 (M)	6813976	1	
Dräger FS-1100 (IR3) CU TR	6814181	1	
Dräger FS-1200 (UV&IR,UV) CU TR	6814182	1	
Dräger FS-1300 (IR) CU TR	6814183	1	
Dräger FS-1400 (M) CU TR	6814184	1	
Dräger Flame 2x0 Air Shield	6813977	1	
Dräger Flame 2x0 Duct Mount	6813978	1	
Tilt Mount Flame Detector	6813979	1	
Weather cover flame detector (SS)	6813189	1	
Weather cover flame detector (ABS)	6813190	1	
Dräger Flame Pole Mount 3"	6813323	1	
Dräger Flame Pole Mount 2"	6813322	1	
Dräger Flame USB RS-485 Kit	6813994	1	
Battery pack for Flame Simulator FS1x00	68 51656	1	
Cable gland M25 II 2G Ex d/e IIC	6851656	1	
Cable gland with IP washer	6851658	1	
Cable gland M25 II 2G Ex e IIC	6851655	1	
Reduction M25 to M20-II 2G 1D Ex d II	6814205	1	
Cable gland M25-II 2G 1D Ex d IIC	6814206	1	

FIRE & GAS DETECTION SYSTEMS

PRODUCT	PART NO	PACKAGING UNIT	CATEGORY
---------	---------	----------------	----------



The 40/40R Single IR Flame Detector detects hydrocarbon-based fuel and gas fires using advanced flame analysis tools. The detector provides early warning of flaming fires working at 4.4 μm for maximum sensitivity, and immunity to false alarms from IR sources such as sunlight and IR projectors.

Requires Tilt Mount for mounting

IR Flame detector 40/40 IR Series - for detection of Hydrocarbon flame only.			
Dräger Flame 2000 (R-211SC)	6813920	1	
Dräger Flame 2000 (R-311SC)	6813921	1	
Dräger Flame Simulator FS-1300 (IR)	6813975	1	
Flame Detector 40/40R-211SC- IR	6813295	1	
Flame Detector 40/40R-211AC - IR	6813297	1	
Accessories			
Weather cover Flame Detector (SS)	6813189	1	
Weather cover Flame Detector (ABS)	6813190	1	
Tilt mount Flame Detector (SS)	6813191	1	
Dräger Flame Simulator FS-1100 (IR3)	6813973	1	
Dräger Flame Simulator FS-1400 (M)	6813976	1	
Dräger Flame Simulator FS-1200 (UV & IR, UV)	6813974	1	
Dräger Flame Simulator FS-1300 (IR)	6813975	1	
Flame Simulator 40/40 - IR3 (20/20-310)	6813192	1	
Flame Simulator 40/40 - Multi IR (20/20-313)	6813193	1	
Flame Simulator 40/40 - UV/IR (20/20-311)	6813194	1	
Flame Simulator 40/40 - IR (20/20-312)	6851390	1	
Flame Simulator FS1100 40/40 IR3/M (multi-device simulator)	6813461	1	
Flame Simulator FS1200 40/40 UV/IR,UV (multi-device simulator)	6813462	1	
Flame Simulator FS1300 40/40 IR	6813463	1	
Beam collimator IR3	6813195	1	
Beam collimator UV - UV/IR	6851391	1	
SharpEye Laser Pointer 77716	6813321	1	
Handheld Pocket PC Diagnostic Kit	6813319	1	
USB / RS485 converter kit , Incl. SW	6813320	1	
Pole Mount (U-Bolt) 2" - (SS)	6813322	1	
Pole Mount (U-Bolt) 3" - (SS)	6813323	1	

FIRE & GAS DETECTION SYSTEMS

PRODUCT	PART NO	PACKAGING UNIT	CATEGORY	
	<p>Dräger Chemlogic 1 is an Analyser used for detection of very low levels of gases (in PPB range) for various application. Typical application involves detection of very low levels of H2S (0 - 90 or 1500 PPB) for odour control application in sewage treatment plants. Other gases available on request.</p>	<p>Please do not discount without prior permission</p>		
<p>Dräger Chemlogic</p>				
<p>The Dräger ChemLogic 1 is a single point continuous monitor for the detection of very low level (PPB) toxic and corrosive gasses. (110 - 240 V AC). Includes SD card for datalogging, Calibration curve for Hydrides (H2S) and paper tape for two months operation. Other calibrations are available on request with no price change.</p>		4206761	1	I
<p>With instant physical verification of the presence of gas, it is the next generation of interference free, low maintenance colorimetric gas detection.</p>				
<p>Gases detected include H2S (0 - 90 or 1500 PPB), hydrides, mineral acids, Phosgene & Diisocyanate.</p>				
<p><i>Place You Put Your Faith</i></p>				
<p><u>For installation in safe areas only</u> Dräger ChemLogic 1 (above) with auto shut off, if ambient air has high Methane content. (110 - 240 V AC). Includes SD card for datalogging, Calibration curve for Hydrides (H2S) and paper tape for two months operation. Other calibrations are available on request with no price change.</p>			1	I
<p>The Chemologic 1 unit is packaged in a stainless steel cabinet along with a PIR3000 and Regard 1 for automatically shutting down the Chemlogic Analyser.</p>				
<p><u>For installation in safe areas only.</u></p>				
<p>Dräger ChemLogic 1 + PIR 3000 + Regard 1 + Explosion proof Purging Pump housed in a stainless steel Cabinet. (110 - 240 V AC). Includes SD card for datalogging, Calibration curve for Hydrides (H2S) and paper tape for two months operation. Other calibrations are available on request with no price change.</p>			1	I
<p>The above combination is for installation of Dräger Chemlogic 1 Gas Analyser in hazardous areas Zone 2. A purged system allows the installation of Chemlogic unit in Zone 2 application, while the PIR 3000 will prevent the Chemlogic Analyser from being exposed to high Methane concentration by shutting off the non Ex Chemlogic Analyser.</p>				
<p><u>For Installation in Zone 2 applications</u></p>				
<p>Spare Cassette H2S (Hydrides) Chemlogic 2 month cassette (1-300-020)</p>		4206746	1	I

FIRE & GAS DETECTION SYSTEMS

PRODUCT	PART NO	PACKAGING UNIT	CATEGORY
Alarms - Audio & Visual /Sounder / Beacons			
Mechtrec / ESS Please do not discount without prior permission			
Hazardous Area Approved Alarming Devices			
BExBG05D-5J (Joules) Xenon 24 V DC Red * Lens - A = Amber, B = Blue, C = Clear, G = Green, R = Red & Y = Yellow. For other colours please specify code.	ESS7111XR	1	I
BExBG10D-10J (Joules) Xenon 24 V DC Red * Lens - A = Amber, B = Blue, C = Clear, G = Green, R = Red & Y = Yellow. For other colours please specify code.	ESS7112XR	1	I
BExBG21-5Joules Xenon 24 V DC Red * Lens - A = Amber, B = Blue, C = Clear, G = Green, R = Red & Y = Yellow. For other colours please specify code.	ESS7113XR	1	I
BExBG21-5Joules Xenon 24 V DC Red * Lens - A = Amber, B = Blue, C = Clear, G = Green, R = Red & Y = Yellow. For other colours please specify code.	ESS7114XR	1	I
BExBGL1 LED Beacon 24 V DC Red * Lens - A = Amber, B = Blue, C = Clear, G = Green, R = Red & Y = Yellow. For other colours please specify code.	ESS7111R	1	I
BExDCA110-05D (110 dB / 5 Joules) Xenon Beacon/Sounder RED * Lens - A = Amber, B = Blue, C = Clear, G = Green, R = Red & Y = Yellow. For other colours please specify code.	ESS6810XR	1	I
BExDCA110-05D (110 dB / 5 Joules) LED Beacon/Sounder RED * Lens - A = Amber, B = Blue, C = Clear, G = Green, R = Red & Y = Yellow. For other colours please specify code.	ESS6850XR	1	I
EX d Combined Sounder Sound output 120dB @ 1m IECEX approved Exd and DIP Volume control Operating Voltage : 24 V DC cable Entry: 2 x M20, IP 66/67 Construction: LM6 Aluminium Housing Painted, SS Guard & Mounting Brackets		1	I

FIRE & GAS DETECTION SYSTEMS

PRODUCT	PART NO	PACKAGING UNIT	CATEGORY
BExDS110D, 32 Tone Electronic Sounder, 110 dB, 24 V DC	ESS6010X	1	I
BExDS120D, 32 Tone Electronic Sounder, 121 dB, 24 V DC	ESS6210X	1	I
BExDH120D, 5 Tone Hootronic Sounder 117 dB, 24 V DC, Grey color	ESS6310X	1	I
<p>IECEX Intrinsically safe Electronic Sounder IS-A105 up to 105 dB Operating Voltage 24 V DC 49 tonnes, IP66. * can combine with L101L-IS Beacon (below) to make sounder/beacon</p> 	ESS2010ISCX	1	I
<p>Intrinsically Safe LED beacon (IECEX Approved) L101L-IS Operating Voltage: 24 VDC, IP 66 ESS7010ISX* : * denotes lens color A = Amber, B = Blue, C = Clear, G = Green, R = Red & Y = Yellow)</p> 	ESS7010ISXR	1	I
<p>IS-MB1 Minialite Intrinsically Safe LED beacon (IECEX Approved) Operating Voltage: 24 VDC, IP 66 ESS0720*AS : * denotes lens color A = Amber, B = Blue, C = Clear, G = Green, R = Red & Y = Yellow)</p> 	ESS0720RAS	1	I
<p>Intrinsically Safe combined Sounder/Beacon (IECEX Approved) IS-MC1 Operating Voltage: 24 VDC, IP 65, Red Color. ESS0730*AS : * denotes lens color A = Amber, B = Blue, C = Clear, G = Green, R = Red & Y = Yellow)</p> 	ESS0730RAS	1	I
<p>Intrinsically Safe Electronic Sounder IS-MA1 up to 100 dB IECEX Approved, IP 65 49 Tones Operating Voltage: 24 V DC</p> 	ESS0710AS	2	I

FIRE & GAS DETECTION SYSTEMS

PRODUCT	PART NO	PACKAGING UNIT	CATEGORY
AL105N combined Sounder & Xenon Beacon - non Ex Output: 105 dB 24 VDC IP 65 UL & Marine Approved. ESS2110N* : * denotes lens color A = Amber, B = Blue, C = Clear, G = Green, R = Red & Y = Yellow)		ESS2110NR	1
AL105N combined Sounder & LED Beacon - non Ex Output: 105 dB, Red Color 24 VDC IP 65 UL & Marine Approved. ESS2110N* : * denotes lens color A = Amber, B = Blue, G = Green, R = Red & Y = Yellow)		ESS2110NR	1
A105N Sounder - non Ex Output: 105 dB, 32 Tones, 24 VDC IP 65 Volume Control		ESS2012N	1
Alarms - Audio & Visual /Sounder / Beacons			
Stahl YL 60Audible and visual alarms Sounder/Strobe combination, Omnidirectional high output sounder, max. 110 db(A) / 1 m. 32 selectable tones IECEX approved Available in colors: Red, Amber, Blue, Yellow Operating Voltage: 24 V DC		TBA	1
FL60 Strobe visual alarms IECEX approved Available in colors: Red, Amber, Blue, Yellow Operating Voltage: 24 V DC		TBA	1
YA60 Sounder Alarm IECEX approved Omnidirectional high output sounder, max. 110 db(A) / 1 m. 32 selectable tones Operating Voltage: 24 V DC		TBA	1
YA90 Sounder Alarm IECEX approved Omnidirectional high output sounder, max. 115 db(A) / 1 m. 32 selectable tones Operating Voltage: 24 V DC		TBA	1

FIRE & GAS DETECTION SYSTEMS

PRODUCT	PART NO	PACKAGING UNIT	CATEGORY
---------	---------	----------------	----------



Dräger SAM 3100 and Dräger SAM 3200 is designed to detect toxic and combustible substances in places; which are difficult to access. The required components for a complete sampling system are mounted on a plate and incorporated in a wall enclosure if required. Non ex and ex-versions of Pumps can be selected, alternatives such as Eductors/Injectors as also available. The transmitter will be supplied with the detectable medium (measuring gas) via a filter element. Every transmitter, which can be used together with a process adapter can be integrated in the sampling system to allow maximum flexibility of the system.

Prices available upon request - Please contact Product Manager

Gas Sampling Systems - SAM 3100/3200			
SAM 3100			
Gas Sampling systems with single gas detector (toxic or flammable) and sample conditioning system	TBA	1	I
"Odour Control Application Sampling system (Sewage Treatment Plant) Sampling system Incl.uding the following with Continuous drain and Solenoid valves 1 x standard SS 316 cabinet (Approx 500 x 500 x 300 mm) 1 x cooling coil & condensate drain 1 x Solenoid Valve (switchable using PLC) with feedback 1 x pump & 3-way valve for calibration 1 x Polytron 7000 HART & Docking station for Polytron 7000 or Polytron 8000 1 x Sensor H2S (low concentration 0 – 10 /100 PPM) 2 x Louvers & 1 x Fan 1 x shade (Optional at extra cost of approx. \$300) 1 x services Incl.uding labor, calibration, assembly, supply of fittings & pipes, leak test etc."			
	TBA	1	I
SAM 3200			
Gas Sampling systems with two gas detector (toxics or flammables) and sample conditioning system	TBA	1	I
"Customised Sampling Conditioning System Incl.uding Stainless steel cabinet fitted with Gas detectors (single or multiple), calibration port, 3 way valve, Automatic or Manual drain, SS piping, Flame arrestors, water & dust filter, Flow regulators, gassing adaptors and Calibration adaptors, designed, assembled & tested as per customer requirements for Ex and non-Ex applications.			
	TBA	1	I

Prices available upon request.

FIRE & GAS DETECTION SYSTEMS

PRODUCT	PART NO	PACKAGING UNIT	CATEGORY
Pumps for Sampling Systems			
Polytron Sampling Unit	8313680		
PSD 3000 (Polytron Sampling Device)	8319270	1	I
Ex d Gas Sampling pump (non IEC Ex) Model: MTI GSP UL Approved.	TBA	1	I



The Wireless Data Transmission is designed to provide a direct wire replacement. Built-in signal strength indicator gives constant feedback on the radio signal.
Frequency 900 MHz or 2.4 GHz

Wireless Solutions			
4...20 mA Wireless for non Ex Application for 2 x Analog Input and 4 x Relays (potential free contacts)			
Wireless-subscriber usable as Transmitter or Receiver 2 x 4...20 mA, 4 x pot.free contact	AG01087	1	I
External Antenna 7 dBi	AG01088	1	I
4...20 mA Wireless for non Ex Application for 2 x Analog Input and 4 x Relays (potential free contacts)			
Wireless-subscriber usable as Transmitter or Receiver 4 x 4...20 mA	AG01089	1	I
External Antenna 7 dBi	AG01088	1	I
Wireless-Gateway (Amplifier) for 4 x 4...20 mA channel only	Optional	AG01090	1 I

FIRE & GAS DETECTION SYSTEMS

PRODUCT	PART NO	PACKAGING UNIT	CATEGORY
---------	---------	----------------	----------



The GDU-Incus is an ultrasonic gas leak detector for detecting airborne ultrasound generated from pressurised gas leaks.

The detector comprises of four independent sensing heads designed using Groveley's patent pending floating crystal technology. The ceramic piezo-electric sensor heads are encased in a metallic housing and sealed against the harshest of environments. The design ensures full functionality from -40°C to +85°C (-55°C option).

Ultrasonic Leak Detector			
Transmitter			
GDU-Incus (SS,Std.Temp,2*M20)	6813224	1	I
GDU-Incus (SS,Std.Temp,2*3/4"NPT)	6813225	1	I
GDU-Incus (SS,Std.Temp,2*M20,HART)	6813226	1	I
GDU-Incus (SS,Std.Temp,2*3/4"NPT,HART)	6813227	1	I
Accessories			
GDU-Incus Mounting Bracket	6813232	1	I
Portable GDU Test Tool GDU-01-TT	6813233	1	I
GDU Performance Target Verification Kit	6813234	1	I
GDU Acoustic / Ultrasonic Mapping Tool	6813235	1	I

Place You Put Your Faith

FIRE & GAS DETECTION SYSTEMS

PRODUCT	PART NO	PACKAGING UNIT	CATEGORY
---------	---------	----------------	----------

WIRELESS IR HYDROCARBON GAS DETECTOR



Truly wireless, the GasSecure GS01 combines single-beam triple-wavelength infrared (IR) technology with extremely low power consumption, to provide fast hydrocarbon gas detection in the most demanding and hazardous of settings. The GS01 creates value for the customer with dramatically reduced installation cost and time, reliable infrared operation, and calibration-free design.

Transmitter

GS01 Wireless IR Hydrocarbon Gas Detector (Includes battery pack AL20712, battery cap AL20708, weather cap AL20709)	AL20700
GS01 demo pack (Includes AL20700, Serial Adapter AL20710, and the demo (Bluetooth) battery pack)	AL20704
GS01-EA Wireless IR Hydrocarbon Gas Detector 5 m With extended antenna, 5m (includes AL20718 and AL20720)	AL20715
GS01-EA Wireless IR Hydrocarbon Gas Detector 10 m With extended antenna, 10m (includes AL20718 and AL20720)	AL20716
GS01-EA Wireless IR Hydrocarbon Gas Detector 20 m With extended antenna, 20m (includes AL20718 and AL20721)	AL20717
GS01 Wireless IR Gas Detector FM (Includes battery pack AL20713, battery cap AL20708, weather cap AL20709)	AL20735
GS01 Wireless IR Gas Detector -5m FM With extended antenna, 5m (includes AL20718 and AL20720)	AL20737
GS01 Wireless IR Gas Detector -10m FM With extended antenna, 10m (includes AL20718 and AL20720)	AL20738
GS01 Wireless IR Gas Detector -20m FM With extended antenna, 20m (includes AL20718 and AL20721)	AL20739

Accessories

Battery pack type 2 without battery cells	AL20712
Battery Pack FM without battery cells	AL20713
Pelicase type 1500 yellow with foam insert for GS01 demo pack	AL20705
Battery cell type SL-2780/S - EUR	AL20706
Battery cap	AL20708
Weather cap	AL20709
Sencity OMNI-S Omni-directional 6 dBi Antenna with bracket (For GS01-EA)	AL20718
Antenna cable with n-type connectors in both ends, 5 m (For GS01-EA)	AL20719
Antenna cable with n-type connectors in both ends, 10 m (For GS01-EA)	AL20720
Antenna cable with n-type connectors in both ends, 20 m (For GS01-EA)	AL20721
GS01 serial adapter (For device provisioning)	AL20710
GS01 sunshade / weather protection	AL20711

FIRE & GAS DETECTION SYSTEMS

PRODUCT	PART NO	PACKAGING UNIT	CATEGORY
Calibration Accessories			
Calibration-/process adapter 2 ACFor Polytron Transmitter	8324093	1	G
Gasing adapter for Polytron 1, 2, 3000, 7000, IR CO2	6806978	1	G
Calibration Adapter Viton for Polytron 1, 2, 3000, 7000, IR CO2	6810536	1	G
Remote calibration adapter for Polytron 1, 2, 3000, 7000, IR CO2	6807955	1	G
Calibration-/Processadapter AC	6809380	1	G
Adapter for test of transmitter Cl2 L / HF/HCl L	4202003	1	G
Calibration adapter IR Ex / IR N2O	6808667	1	G
Supplemental calibration adapter IR Ex HC + IR CO2	6809240	1	G
Calibration Adapter IR for splashguard	6809780	1	G
DSIR Calibration Adapter	6810859	1	G
Start-up kit f. HF/HCl L and AC (Pipette, electrolyte for initial operation of max. 4 channels)	6809381	1	G
Start-up kit Cl2 L (Pipette, electrolyte for initial operation of max. 4 channels)	6809382	1	G
Gas Calibration Bag 10 L (for Pyrolyzer)	6807068	1	G
Calibration chamber for solvents	6802206	1	G
Calibration bottle for calibration with test gas ampoules	6803407	1	G
Calibration Gas Ampoules			
Ampoule H2S 10 ppm	6808140	5	G
Ampoule H2S 20 ppm	6808141	5	G
Ampoule H2S 40 ppm	6808142	5	G
Ampoule H2S 100 ppm	6808143	5	G
Ampoule SO2 1 ppm	6807925	5	G
Ampoule SO2 4 ppm	6807926	5	G
Ampoule SO2 10 ppm	6807763	5	G
Ampoule SO2 50 ppm	6807764	5	G
Ampoule NO2 10 ppm	6807765	5	G
Ampoule NO2 50 ppm	6807766	5	G
Ampoule CO 100 ppm	6807920	5	G
Ampoule CO 300 ppm	6807921	5	G
Ampoule NH3 50 ppm	6807924	5	G
Ampoule NH3 300 ppm	6807923	5	G
Ampoule Cl2 8 ppm	6807928	5	G
Ampoule HCN 10 ppm	6807929	5	G

Dräger Region South East Europe | Rev: 0 | Subject to modification! | www.draeger.com

Place You Put Your Faith
PORTABLE
GAS DETECTION

PERSONAL
PROTECTION
EQUIPMENT

DRUG & ALCOHOL
DETECTION

MASKS & FILTERS

FIRE & GAS
DETECTION
SYSTEMS

ENGINEERED
SOLUTIONS

SERVICE,
TRAINING & RENTAL

DIVING
TECHNOLOGY

FIRE & GAS DETECTION SYSTEMS

PRODUCT	PART NO	PACKAGING UNIT	CATEGORY
General Accessories			
PSD 3000 (Polytron Sampling Device)	8319270	1	G
Remote Sensor Adapter Polytron 7000	8317275	1	G
Remote cable + plug 5 m Polytron 7000	8317270	1	G
Remote cable + plug 15 m Polytron 7000	8317998	1	G
Remote cable + plug 30 m Polytron 7000	8317999	1	G
Remote Duct adapter Polytron 7000	8317617	1	G
Duct Mount Kit Polytron 3000/7000	8317150	1	G
Cable Entry Set Polytron 7000	8317282	1	G
Cabel Connector Relay Polytron 7000	1890086	1	G
Mounting Set P2IR/P3000/P7000	6809951	1	G
Splash Guard	6807549	1	G
Calibration Adapter Viton	6810536	1	G
Gasing Adapter	6806978	1	G
Calibration-/Processadapter AC	6809380	1	G
Splash guard Acidic Compounds	6809379	1	G
Pump adapter Polytron 7000	8320900	1	G
Pump adapter AC Polytron 7000	8317976	1	G
Set Hawke Cable Gland Polytron 3000 / 7000	8319029	1	G
IR-Adapter Palm M515, compl.	8318080	1	G
IR-Adapter Tungsten T3, compl.	8317430	1	G
IR-Adapter ZIRE 31, compl.	8317440	1	G
Duct Mount Kit Polytron 3000/7000	8317150	1	G
Mounting Set P2IR/P3000/P7000	6809951	1	G
Splash Guard	6807549		G
Calibration Adapter Viton	6810536	1	G
Gasing Adapter	6806978	1	G
Calibration-/Processadapter AC	6809380	1	G
Splash guard Acidic Compounds	6809379		G
Set Hawke Cable Gland Polytron 3000 / 7000	8319029	1	G
Remote Sensor Polytron 2 (approx. 5 m cable)	8313960	1	G
Duct Mounting Kit for Remote Adapter 8313960	8314097	1	G

FIRE & GAS DETECTION SYSTEMS

PRODUCT	PART NO	PACKAGING UNIT	CATEGORY
Hand Held Terminal Polytron 2	8313602	1	G
Adapter cable (for connection of DraegerSensors Type 2 to old Polytron 1 Transmitters, delivered before January 1995)	8313188	1	G
Adapter Shuttle Sensor / DraegerSensor (mounting plate to fit DraegerSensors instead of shuttle Sensor to Polytron "1" transmitters)	6809557	1	G
Polytron IR Splash Guard	6809750	1	G
Polytron IR Calibration Adapter for splashguard	6809780	1	G
Polytron IR Flowcell	6809450	1	G
Polytron IR Gassing Adapter	6809946	1	G
Polytron IR Process Cuvette	6810780	1	G
Dräger PRC 3000, remote control software	8318906	1	G
Dräger PRC 3010, remote control software	8319590	1	G
Polytron IR Bump Test Adapter	6810985	1	G
Polytron IR Insect Guard	6810162	1	G
Polytron IR Hydrophobic Filter	6810519	1	G
Mounting Set P2IR/P3000/P7000	6809951	1	G
DSIR Splash Guard	6810796	1	G
DSIR Calibration Adapter	6810859	1	G
DSIR Gassing / Process Adapter	6811330	1	G
DSIR Weather Guard	6811135	1	G
DSIR Cable Gland M20	6811323	1	G
Mounting Set d	6811426	1	G
Mounting Set e	6811427	1	G
DSIR Duct Mount Set	6810995	1	G
Magnet W/Key Chain P5000/8000	4544101	1	G
Junction Box EEx e (regular box)	6811299	1	G
Junction Box EEx e (octa box)	6811159	1	G
Junction Box EEx d	6811161	1	G
Splash guard IR Ex / IR N2O	6808671	1	G
Calibration adapter IR Ex / IR N2O	6808667	1	G
Supplemental calibration adapter IR Ex HC + IR CO2	6809240	1	G
Calibration Adapter Viton	6810536	1	G
Gassing Adapter	6806978	1	G
Dust Filter (not suitable for DrägerSensor Ex LC M)	6810537	1	G

FIRE & GAS DETECTION SYSTEMS

PRODUCT	PART NO	PACKAGING UNIT	CATEGORY
Selective Filters for Electro-Chemical Sensors			
Dust filter (electrochemical DrägerSensors Type 3)	6809595	1	G
Selective Filter AS	6806445	1	G
Selective Filter A2F (for DrägerSensor CO, CO LS and H2)	6809684	10	G
Selective Filter MF (for Dräger Sensor Hydrides and PH3/Ash3)	6809638	1	G
Selective Filter K2F (for DrägerSensor COCl2)	6809933	1	G
Selective Filter NF (for DrägerSensor HCl)	6809643	1	G
Selective Filter HSF (for DrägerSensor Hydrides)	6809862	1	G
Selective Filter K1F (for DrägerSensor SO2)	6809663	1	G
Selective Filter PF	6810748		G
Variogard Accessories			
VarioGard Akkumodul 28 VDC, 7Ah w/o battery	8315178	1	G
Pb battery-set	8315569	1	G
Cable gland M 20 x 1.5, 10 each	8315420	1	G
VarioGard Transmitter protection cage	8315987	1	G
Relay module	8315238	1	G
Convertermodule	8315226	1	G
Wallmount.Housing VarioGard	8315647	1	G
VarioGard Repeater	8317146	1	G
Polytron 5000 & 8000 Spares Parts and Accessories			
Bucket P8x00 CAT 4-20/HART,SPPT	4544788	1	G
Bucket P8x00 CAT 4-20/HART relay,SPPT	4544789	1	G
Bucket P8x00 IR 4-20/HART,SPPT	4544795	1	G
Bucket P8x00 IR 4-20/HART relay,SPPT	4544796	1	G
KIT,ENCL Hardware,PX00,SPPT	4544167	1	G
Feedthrough 14 Wires,SPPT	4544168	1	G
Feedthrough 9 Wires,SPPT	4544169	1	G
Feedthrough 3 Wires,SPPT	4544182	1	G
Bezel,P5X00,SPPT	4544183	1	G
Bezel,TX,SPPT	4544184	1	G
Board,TX,SPPT	4544185	1	G
PCB Main,EXPL,P5X00,SPPT	4544186	1	G
PCB Main,PIR,P5X00,SPPT	4544187	1	G

FIRE & GAS DETECTION SYSTEMS

PRODUCT	PART NO	PACKAGING UNIT	CATEGORY
DRAEGER Sensor ASSY,PX00,SPPT	4544189	1	G
PCB RELAY,P5X00,SPPT	4544297	1	G
E-Box Hardware, PX00, SPPT	6812838	1	G
PCB E-Box, Px000, SPPT	6812839	1	G
Bucket P8x00 EC 4-20/HART,SPPT	4544781	1	G
Bucket P8x00 EC 4-20/HART relay, SPPT	4544782	1	G
Galvanic Isolator, SPPT	4544367	1	G
SIOS EC Sensing Head, SPPT	4544368	1	G
PCB EC Sensing Head Remote, SPPT	4544369	1	G
Splash Guard PIR 7200	6811912	1	G
Status Indicator PIR 7200	6811920	1	G
Splash Guard PIR 7000	6811911	1	G
Status Indicator PIR 7000	6811625	1	G
Junction Box S	4544098	1	G
Junction Box A	4544099	1	G
E-box Power only version (Includes 1 cable gland) / docking station	6812420	1	G
E-box Power and Relay version (Includes 2 cable glands) / Docking station	6812275	1	G
Process Adapter PIR 7000 (Plastic)	6811915	1	G
Process Cuvette PIR 7000 (Stainless Steel)	6811415	1	G
Calibration Adapter PIR 7000	6811610	1	G
Insect Guard PIR 7000	6811609	1	G
Hydrophobic Filter PIR 7000	6811890	1	G
Flowcell PIR 7000	6811490	1	G
Flowcell PIR 7000 Duct	6811945	1	G
Bump Test Adapter PIR 7000	6811630	1	G
Bump Test Adapter PIR 7000 Duct	6811990	1	G
Flowcell PIR 7200	6811910	1	G
Bump Test Adapter PIR 7200	6811930	1	G
Magnet W/Key Chain P5000/8000	4544101	1	G
Irda Interface Assy	4544197	1	G
Pipe Mount Kit P5x00 /8x00	4544198	1	G
Duct Mount Kit Polytron 5700/8700/5720/8720/PIR 7x00	6812300	1	G
Flowcell PIR 7000 Duct	6811945	1	G
Bump Test Adapter PIR 7000 Duct	6811990	1	G

FIRE & GAS DETECTION SYSTEMS

ABBREVIATIONS

Aluminium	A
Aluminium	Al
Asea Brown Boveri	ABB
Acrylo nitrile Butadiene Styrene (thermo plastic)	ABS
Acidic Compounds	AC
Auxillary Interface	AI
Aluminum	AL
Appareils destinés à être utilisés en ATmosphères Explosibles	ATEX
CENELEC: Comité Européen de Normalisation Électrotechnique; (European Committee for Electrotechnical Standardization)"	CEN
Canadian Standards Association	CSA
German Industrial Standard (Deutsches Institut für Normung)	DIN
DrägerSensor IR	DSIR
European Ex approval flame proof	EEx d
European Ex approval increased safety	EEx e
Enhanced Sensitivity	ES
Ex-Sensing head with Remote sensor	Ex-R
Fieldbus	FB
FOUNDATION Fieldbus	FF
FM Approvals LLC (FM) (formerly Factory Mutual Research Corporation)	FM
Fast Propane	FP
Fixed Gas detection System	FGDS
Flame & Gas detection System	FGDS
Gas Detection Systems	GDS
Highway Addressable Remote Transducer (Protocol)	HART
High Concentration	HC
Handheld Terminal	HHT
Handheld Terminal box for Handheld	HHT-H
Handheld Terminal box for Transmitter	HHT-T
Human Machine Interface	HMI
High Temperature	HT
Hardware	HW
In Line	IL



Place You Put Your Faith

FIRE & GAS DETECTION SYSTEMS

Ingress Protection	IP
Infrared	IR
Leak Detector	L
Low Concentration	LC
Local Operating Network	LON
Longterm stability	LS
Metric thread (M20 or M25)	M
Non Display	ND
Non Display Fixed connection	NDF
Non Display for handheld terminal	NDH
National Pipe Thread (1/2" or 3/4")	NPT
National Television System Committee (analog TV)	NTSC
OLE for Process Control	OPC
Phase Alternating Line (a colour-endcoding used in TV)	PAL
PROFIBUS Process Application	Profibus PA
PROFIBUS	PB
Probability of Failure on Demand (SIL)	PFD
Programmable logic Controller	PLC
Poison Resistant	PR
Polytron Remote Control	PRC
Polytron Sampling Device	PSD
Power Supply Unit	PSU
Receiver	Rx
Regard Visualization Panel	RVP
Stainless Steel 316	S
Stainless Steel 316	SS
Sampling Unit	SAM
Semiconductor	SC
Analog Display (channel card Polytron SE Ex)	SE Ex/ A
Bargraph Display (channel card Polytron SE Ex)	SE Ex/ B
Safety Integrity Level	SIL
Software	SW
Technischer Überwachungs-Verein (Technical Inspection Association)	TÜV



Place You Put Your Faith

FIRE & GAS DETECTION SYSTEMS

Transmitter	Tx
Underwriters Laboratories Inc.	UL
Uninterrupted power supply	UPS
Universal Serial Bus	USB
Ultra Violet	UV
Ultraviolet & Infrared	UV/IR
Explosion proof	XP
Extra-small	XS
Extra-small	XS



Place You Put Your Faith

ENGINEERED SOLUTIONS

**PORTABLE COMPRESSORS**

Junior 100
PE 100
Dräger PE 200/250/300 TE
Mariner 200/250/320

STATIONARY COMPRESSORS

Mini Verticus MV III
PE-MVE
PE 300/400/550/700/850
PE 250 HE / 300 HE

ACCESSORIES

B-KOOL Refrigerant Type Dryer
Compressor Blocks

FILTER SYSTEMS

Air Purification System

BREATHING GAS COMPONENTS

Air Guard 4200/4500/5200/5500

FILLING SYSTEMS

Filling Speed Control
Safe Filling System
L & W Safety Filling Cabinet

BREATHING GAS COMPONENTS

375 Air Guard 4200/4500/5200/5500 404
377 Aerotest 405
379 OxyTest 2000 407
381 Oxygen Boosters 408
Oxygen Generators 413
Mixing Units/Cartridges/Drums/Curtains/Filter Protection 415

TRAINING & WORKSHOP SYSTEMS /EQUIPMENT

390 Hose Drying System / Equipment Drying Systems 416
CombiClean / CombiDry / CombiPac 417
397 Furnishing Programs for Workshops 420
398 Treadmill/Endless Ladder 424
Arm Ergometer/Bicycle Dynavit 425
399 Fire Extinguisher Trainer 426
Fog Machines/Fire & Sound Box 427

FIRE TRAINING SYSTEMS

400 Truck Rescue Trainer 429
401 Aircraft Simulators 430
402 Training Containers 431
403

Place You Put Your Faith

ENGINEERED SOLUTIONS

MOBILE COMPRESSORS

		Time to fill cylinders from empty to 200 bar					Time to fill cylinders from empty to 300 bar				
		6.8	7	9	10	12	6.8	7	9	10	12
		Minutes					Minutes				
140 L/min	JUNIOR 100 Single phase electric, Three phase electric, Petrol	14	14	18	20	24	20	21	27	30	36
	Single phase electric, Three phase electric, Petrol	14	14	18	20	24	20	21	27	30	36
140 L/min	Petrol, Three phase electric	10	10	13	14	17	15	15	19	21	26
170 L/Min	Three phase electric	8	8	11	12	14	12	12	16	18	21
200 L/min	PE-200-TE Three phase electric	7	7	9	10	12	10	11	14	15	18
	MARINER 200 Petrol, Three phase electric	7	7	9	10	12	10	11	14	15	18
250 L/min	PE-250-TE Three phase electric	5	6	7	8	10	8	8	11	12	14
	MARINER 250 Petrol, Three phase electric	5	6	7	8	10	8	8	11	12	14
300 L/min	MARINER 320L/MIN Petrol, Three phase electric	4	4	6	6	8	6	7	8	9	11



ST-771-2004

Junior 100



ST-773-2004

Mariner



Notus



PE

Dräger Region South East Europe | Rev: 0 | Subject to modification! | www.draeger.com

Place You Put Your Faith

PORTABLE
GAS DETECTIONPERSONAL
PROTECTION
EQUIPMENTDRUG & ALCOHOL
DETECTION

MASKS & FILTERS

FIRE & GAS
DETECTION
SYSTEMSENGINEERED
SOLUTIONSSERVICE,
TRAINING & RENTALDIVING
TECHNOLOGY

ENGINEERED SOLUTIONS

HORIZONTAL COMPRESSORS

		Time to fill cylinder from empty to 200 bar					Time to fill cylinder from empty to 300 bar				
		6.8	7	9	10	12	6.8	7	9	10	12
		Minutes					Minutes				
170 L	Three phase electric	8	8	11	12	14	12	12	16	18	21
250 L/min	PE-250-HE Three phase electric	5	6	7	8	10	8	8	11	12	14
300 L/min	PE-300-HE Three phase electric	5	5	6	7	8	7	7	9	10	12

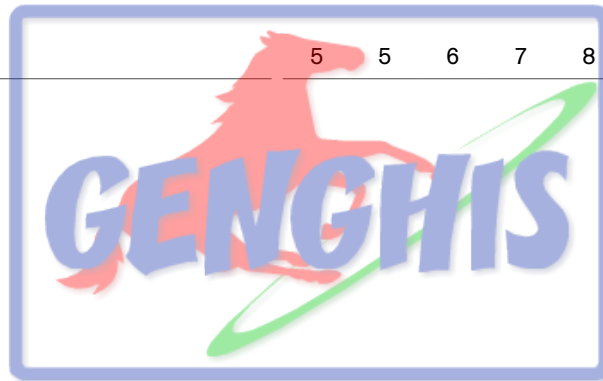

Place You Put Your Faith



ST-172-2008

PE-HE

ENGINEERED SOLUTIONS

VERTICAL COMPRESSORS

		Time to fill cylinders from empty to 200 bar					Time to fill cylinders from empty to 300 bar				
		6.8	7	9	10	12	6.8	7	9	10	12
		Minutes					Minutes				
150 L/Min	MINI VERTICUS 150 L/min	9	9	12	13	16	14	14	18	20	24
200 L/Min	MINI VERTICUS 200 L/min	7	7	9	10	12	10	11	14	15	18
250 L/min	MINI VERTICUS 250 L/min	5	5	7	8	10	8	8	11	12	14
	VERTICUS 260 L/min	5	5	7	8	9	8	8	10	12	14
300 L/min	VERTICUS 320 L/min	4	4	6	6	8	6	7	8	9	11
	PE 300-VSE 300 L/min	5	5	6	7	8	7	7	9	10	12
400 L/min	VERTICUS 370 L/min	4	4	5	5	6	6	6	7	8	10
	PE 400-VSE 400 L/min	3	4	5	5	6	5	5	7	8	9
	VERTICUS 450 L/min	3	5	4	4	5	5	5	6	7	8

Place You Put Your Faith



PE-VSE

ENGINEERED SOLUTIONS

VERTICAL COMPRESSORS

		Time to fill cylinders from empty to 200 bar					Time to fill cylinders from empty to 300 bar				
		6.8	7	9	10	12	6.8	7	9	10	12
		Minutes					Minutes				
500 L/min	VERTICUS 540 L/min	3	3	3	4	4	4	4	5	6	7
	PE 550-VSE 550 L/min	2	3	3	4	4	4	4	5	5	7
600 to 850 L/min	VERTICUS 680 L/min	2	2	3	3	4	3	3	4	4	5
	PE 700-VSE 700 L/min	2	2	3	3	3	3	3	4	4	5
	PE 850-VSE 850 L/min	2	2	2	2	3	2	2	3	4	4

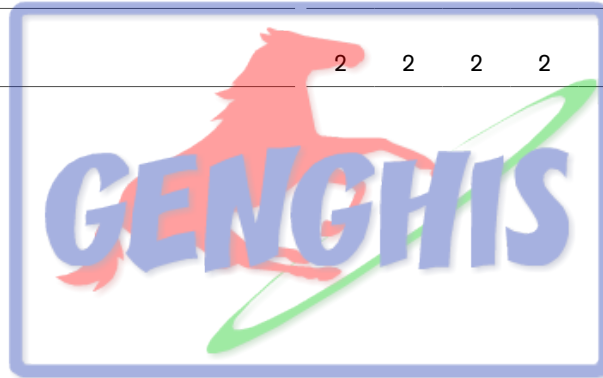

Place You Put Your Faith

ENGINEERED SOLUTIONS

PRODUCT	DRIVE	PART NO	PACKAGING UNIT	CATEGORY
---------	-------	---------	----------------	----------

JUNIOR 100

The Dräger JUNIOR 100 is the most compact, mobile Dräger diving compressor.

General

- Portable
- Noise level 87 dB(A) at 1m distance

SCOPE OF DELIVERY**Compressor block**

- Micronic intake filter
- Intermediate cooler, after-cooler
- Intermediate separator
- Intermediate pressure safety valves
- Compressor unit and drive motor are mounted on a base frame

Filter system for pure breathing air

- P21 filter system

Condensate drainage

- Manual condensate drain
- Automatic condensate drain as option

B-Timer

- For monitoring the cartridge saturation, with operating hours indication

Filling device for PN 200 or 300 bar

Consisting of:

- 1x Filling hose, 1m long
- 1x Filling Valve PN 200 or 300 bar (self venting), pressure gauge, cylinder DIN connection G5/8

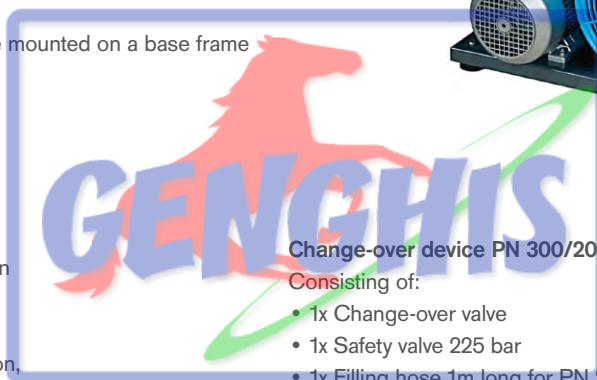

Change-over device PN 300/200 bar (as option)

Consisting of:

- 1x Change-over valve
- 1x Safety valve 225 bar
- 1x Filling hose 1m long for PN 200 bar
- 1x Filling hose 1m long for PN 300 bar
- 1x Filling valve PN 200 bar (self venting), pressure gauge, cylinder DIN connection G5/8
- 1x Filling valve PN 300 bar (self venting), pressure gauge, cylinder DIN connection G5/8

Place You Put Your Faith

JUNIOR 100-B-PN 200 bar, 1x fill hose PN 200 bar (basic version)	Petrol Engine	6531089	1	532
JUNIOR 100-B-PN 300 bar, 1x fill hose PN 300 bar (basic version)	Petrol Engine	6531090	1	532
JUNIOR 100-B-PN 200 bar, 2x fill hose PN 200 bar	Petrol Engine	6568666	1	532
JUNIOR 100-B-PN 300 bar, 2x fill hose PN 300 bar	Petrol Engine	6568667	1	532
JUNIOR 100-B-PN 200/300 bar	Petrol Engine	6531091	1	532
JUNIOR 100-B-PN 200 bar, with Automatic Condensate Drain	Petrol Engine	6568660	1	532
JUNIOR 100-B-PN 300 bar, with Automatic Condensate Drain	Petrol Engine	6568661	1	532
JUNIOR 100-B-PN 200/300 bar, with Automatic Condensate Drain	Petrol Engine	6568662	1	532
JUNIOR 100-E-PN 200 bar, 1x fill hose PN 200 bar (basic version)	3-phase	6531083	1	532
JUNIOR 100-E-PN 300 bar, 1x fill hose PN 300 bar (basic version)	3-phase	6531047	1	532
JUNIOR 100-E-PN 200 bar, 2x fill hose PN 200 bar	3-phase	6568668	1	532
JUNIOR 100-E-PN 300 bar, 2x fill hose PN 300 bar	3-phase	6568669	1	532
JUNIOR 100-E-PN 200/300 bar	3-phase	6531085	1	532
JUNIOR 100-E PN 200 bar, with Automatic Condensate Drain	3-phase	6568654	1	532

Dräger Region South East Europe | Rev: 0 | Subject to modification! | www.draeger.com

Place You Put Your Faith

PORTABLE
GAS DETECTION

PERSONAL
PROTECTION
EQUIPMENT

DRUG & ALCOHOL
DETECTION

MASKS & FILTERS

FIRE & GAS
DETECTION
SYSTEMS

ENGINEERED
SOLUTIONS

SERVICE,
TRAINING & RENTAL

DIVING
TECHNOLOGY

ENGINEERED SOLUTIONS

PRODUCT	DRIVE	PART NO	PACKAGING UNIT	CATEGORY
JUNIOR 100-E PN 300 bar, with Automatic Condensate Drain	3-phase	6568655	1	532
JUNIOR 100-E PN 200/300 bar, with Automatic Condensate Drain	3-phase	6568656	1	532
JUNIOR 100-W-PN 200 bar, 1x fill hose PN 200 bar (basic version)	Single Phase	6531086	1	532
JUNIOR 100-W-PN 300 bar, 1x fill hose PN 300 bar (basic version)	Single Phase	6531048	1	532
JUNIOR 100-W-PN 200/300 bar	Single Phase	6531088	1	532
JUNIOR 100-W PN 200 bar, with Automatic Condensate Drain	Single Phase	6568657	1	532
JUNIOR 100-W PN 300 bar, with Automatic Condensate Drain	Single Phase	6568658	1	532
JUNIOR 100-W PN 200/300 bar, with Automatic Condensate Drain	Single Phase	6568659	1	532
Additional components (prices only valid in conjunction with compressor order)				
Automatic Condensate Drain for Petrol Engine (single pressure range)			1	
Automatic Condensate Drain for Single Phase (single pressure range)			1	
Automatic Condensate Drain for Three Phase (single pressure range)			1	
Automatic Condensate Drain for Petrol Engine (dual pressure range)			1	
Automatic Condensate Drain for Single Phase (dual pressure range)			1	
Automatic Condensate Drain for Three Phase (dual pressure range)			1	
Filling device 2x PN 200 bar			1	
Filling device 2x PN 300 bar			1	
Stainless Steel Frame			1	

Place You Put Your Faith

ENGINEERED SOLUTIONS

PRODUCT	DRIVE	PART NO	PACKAGING UNIT	CATEGORY
---------	-------	---------	----------------	----------

PE 100

The mobile compressor Dräger PE 100 is by far the smallest and most lightweight of the mobile Dräger compressors.

General

- Drive versions of petrol and electric
- Portable
- Noise level 87 dB(A) at 1m distance

SCOPE OF DELIVERY**Compressor block**

- 3-stage
- Micronic intake filter
- Intermediate cooler
- After-cooler
- Intermediate separator after the 2nd stage
- Intermediate pressure safety valve
- Base frame powder-coated Steel

PE 100-B

Petrol motor 4-stroke

PE 100-E

Incl. connection cable and plug for 415V/50Hz

PE 100-W

Motor protection switch and connection cable Incl. plug 230V/50Hz

Condensate drainage

- Manual condensate drain

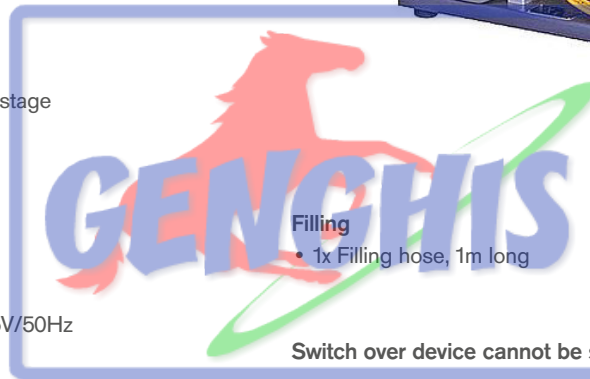
**Triplex filter system P11**

- Filter container
- Long life filter cartridges
- Final pressure safety valve

Place You Put Your Faith

Dräger PE 100 - B - PN 200 bar	Petrol Engine	6534533	1	532
Dräger PE 100 - B - PN 300 bar	Petrol Engine	6534534	1	532
Dräger PE 100 - E - PN 200 bar	3-phase	6534537	1	532
Dräger PE 100 - E - PN 300 bar	3-phase	6534538	1	532
Dräger PE 100 - W - PN 200 bar	Single Phase	6534535	1	532
Dräger PE 100 - W - PN 300 bar	Single Phase	6534536	1	532
		6536283	1	532

Pellicase box for PE 100 E/W

ENGINEERED SOLUTIONS

PRODUCT	DRIVE	PART NO	PACKAGING UNIT	CATEGORY
---------	-------	---------	----------------	----------

Additional components (prices only valid in conjunction with compressor order)

Automatic Condensate Drain for Petrol Engine (single pressure range)			1	
Automatic Condensate Drain for Single Phase (single pressure range)			1	
Automatic Condensate Drain for Three Phase (single pressure range)			1	
Automatic Condensate Drain for Petrol Engine (dual pressure range)			1	
Automatic Condensate Drain for Single Phase (dual pressure range)			1	
Automatic Condensate Drain for Three Phase (dual pressure range)			1	
Filling device 2x PN 200 bar			1	
Filling device 2x PN 300 bar			1	
Filter system P31			1	
B-Timer (Not possible when SECURUS is used, upgrade possible)			1	
Filling device 2 x PN 200 bar			1	
Filling device 2 x PN 300 bar			1	
Switch-over device (SOD) 1x PN 200 bar + 1 x PN 300 bar			1	
Capitano 140 E				
Carrying Trolley			1	
Crash frame (necessary for options)			1	
Air intake telescope			1	
Compressor control Incl. final pressure switch off, automatic condensate drain, 10L collecting tank			1	
Automatic condensate drain for units with interstage separator after 1st stage			1	
Separator after 1st stage			1	
Filter system P31			1	
B-Timer (Not possible when SECURUS is used, upgrade possible)			1	
Filling device 2 x PN 200 bar			1	
Filling device 2 x PN 300 bar			1	
Switch-over device (SOD) 1x PN 200 bar + 1 x PN 300 bar			1	



Place You Put Your Faith

ENGINEERED SOLUTIONS

PRODUCT	DRIVE	PART NO	PACKAGING UNIT	CATEGORY
---------	-------	---------	----------------	----------

PE 200/250/300 TE

The PE 200 to 300 TE series combines a particular compact design with high delivery volumes and easy operation.

General

- Portable
- 3-Stage (PE 200/250), 4-Stage(PE 320)
- Noise level 87 dB(A) at 1m distance

SCOPE OF DELIVERY**Compressor block**

- 3 stage
- Micronic intake filter
- Intermediate cooler
- After-cooler
- Intermediate separator
- Intermediate pressure safety valve
- Support frame

Triplex Filter System P21 / P31 / P42

- P21 filter system
- P31 and P42 as option
- B-Timer as option

Condensate drainage

- Manual condensate drainage
- Automatic drainage with electric control as option

**Filling device for PN 200 or 300 bar:**

Filling connection consists of:

- 1x Filling hose 1m long
- 1x Filling Valve PN 200 or 300 bar, with self venting, pressure gauge, cylinder DIN connection G5/8

Filling device with change-over device PN 200/300 bar (optional)

Filling device 1xPN 200 + 1x PN 300 bar

Change-over device and additional safety valve 225 bar Included.

* Change over device is NOT possible for filter system P31

Place You Put Your Faith

Dräger PE 200 TE - PN 200 bar	3-phase	6534370	1	532
Dräger PE 200 TE - PN 300 bar	3-phase	6534371	1	532
Dräger PE 200 TE - PN 200/300 bar	3-phase	6534372	1	532
Dräger PE 250 TE - PN 200 bar	3-phase	6534373	1	532
Dräger PE 250 TE - PN 300 bar	3-phase	6534374	1	532
Dräger PE 250 TE - PN 200/300 bar	3-phase	6534375	1	532
Dräger PE 300 TE - PN 200 bar	3-phase	6534364	1	532
Dräger PE 300 TE - PN 300 bar	3-phase	6534365	1	532
Dräger PE 300 TE - PN 200/300 bar	3-phase	6534366	1	532

Additional components (prices only valid in conjunction with compressor order)

PE 200 TE

Electronic control with automatic condensate drain and final pressure switch off	1
B-Timer (Not possible when SECURUS is used, upgrade possible)	1
Filling device 2x PN 200 bar	1
Filling device 2x PN 300 bar	1
Switch-over device (SOD) 1x PN 200 bar + 1 x PN 300 bar	1

ENGINEERED SOLUTIONS

PRODUCT	DRIVE	PART NO	PACKAGING UNIT	CATEGORY
PE 250 TE				
Electronic control with automatic condensate drain and final pressure switch off			1	
Filter upgrade P31 instead of P21			1	
B-Timer (Not possible when SECURUS is used, upgrade possible)			1	
Filling device 2x PN 200 bar			1	
Filling device 2x PN 300 bar			1	
Switch-over device (SOD) 1x PN 200 bar + 1 x PN 300 bar			1	
PE 300 TE				
Electronic control with automatic condensate drain and final pressure switch off			1	
Electronic control with automatic condensate drain and final pressure switch off and SECURUS			1	
Filter upgrade P31 instead of P21			1	
Filter upgrade P42 instead of P21			1	
B-Timer (Not possible when SECURUS is used, upgrade possible)			1	
Filling device 2x PN 200 bar			1	
Filling device 2x PN 300 bar			1	
Switch-over device (SOD) 1x PN 200 bar + 1 x PN 300 bar			1	

Place You Put Your Faith

ENGINEERED SOLUTIONS

PRODUCT	DRIVE	PART NO	PACKAGING UNIT	CATEGORY
---------	-------	---------	----------------	----------

MARINER 200/250/320

The universal mobile compressors Dräger MARINER 200/250/320 are ideally suited for professional applications under the most extreme operating conditions.

General

- Portable
- 3-Stage (Mariner 200/250), 4-Stage (Mariner 320)
- Noise level 83 dB(A) at 1m distance

SCOPE OF DELIVERY**Compressor block**

- Micronic intake filter
- Intermediate cooler
- After-cooler
- Intermediate separator
- Intermediate pressure safety valve

Air Intake Hose

3m long (only for combustion motors)

Filter system for pure breathing air

- P21 filter system for Mariner 200
- P31 filter system for Mariner 250/320
- P41 with SECURUS as option
- B-Timer for Mariner 320 (for other models as option)

Condensate drainage

- Manual condensate drainage
- Automatic drainage with electric control as option



Place You Put Your Faith

Filling device for PN 200 or 300 bar:

Mariner 200/250 with 2 filling connections (2x PN 200 or 300 bar)
Mariner 320 with 4 filling connection (4x PN 200 or 300 bar)

Filling connection consists of:

- 1x Filling hose 1m long
- 1x Filling Valve PN 200 or 300 bar (self venting), pressure gauge, cylinder DIN connection G5/8

Change-over device PN 200/300 bar (optional)

Mariner 200/250 with one filling connection PN 200 and PN 300 bar each
Mariner 320 with two filling connection PN 200 and PN 300 bar each
Change-over device and additional safety valve 225 bar Included.

Mariner 200 E - PN 200 bar	3-phase	6531116	1	532
Mariner 200 E - PN 300 bar	3-phase	6531117	1	532
Mariner 200 E - PN 200/300 bar	3-phase	6531118	1	532
Mariner 200 B - PN 200 bar	Petrol	6531119	1	532
Mariner 200 B - PN 300 bar	Petrol	6531120	1	532
Mariner 200 B - PN 200/300 bar	Petrol	6531121	1	532
Mariner 250 E - PN 200 bar	3-phase	6531110	1	532
Mariner 250 E - PN 300 bar	3-phase	6531111	1	532
Mariner 250 E - PN 200/300 bar	3-phase	6531112	1	532
Mariner 250 B - PN 200 bar	Petrol	6531113	1	532
Mariner 250 B - PN 300 bar	Petrol	6531114	1	532
Mariner 250 B - PN 200/300 bar	Petrol	6531115	1	532

ENGINEERED SOLUTIONS

PRODUCT	DRIVE	PART NO	PACKAGING UNIT	CATEGORY
Mariner 320 E - PN 200 bar	3-phase	6531104	1	532
Mariner 320 E - PN 300 bar	3-phase	6531105	1	532
Mariner 320 E - PN 200/300 bar	3-phase	6531106	1	532
Mariner 320 B - PN 200 bar	Petrol	6531107	1	532
Mariner 320 B - PN 300 bar	Petrol	6531108	1	532
Mariner 320 B - PN 200/300 bar	Petrol	6531109	1	532

Special Accessories (prices only valid in conjunction with compressor order)

Mariner 200 B

Carrying Trolley	1
Air intake telescope	1
Automatic condensate drain, Incl. 10L collecting tank, final pressure switch off	1
Automatic condensate drain for units with interstage separator after 1st stage	1
Separator after 1st stage	1
Filter system P31	1
Filter system P41	1
B-Timer (Not possible when SECURUS is used, upgrade possible)	1
Filling device 4 x 200 bar	1
Filling device 4 x 300 bar	1
Switch-over device (SOD) 1x PN 200 bar + 1 x PN 300 bar	1
Electric Start	1

Mariner 200 E

Carrying Trolley	1
Air intake telescope	1
Compressor control Incl. final pressure switch off, automatic condensate drain, 10L collecting tank	1
Automatic condensate drain for units with interstage separator after 1st stage	1
Separator after 1st stage	1
B-KOOL-680S(Standalone)	1
B-KOOL mounting kit (necessary)	1
Filter system P31	1
Filter system P41	1
SECURUS for P41 filter only	1
B-Timer (Not possible when SECURUS is used, upgrade possible)	1
Filling device 4 x 200 bar	1
Filling device 4 x 300 bar	1
Switch-over device (SOD) 1x PN 200 bar + 1 x PN 300 bar	1

Dräger Region South East Europe | Rev: 0 | Subject to modification! | www.draeger.com

Place You Put Your Faith

PORTABLE
GAS DETECTION

PERSONAL
PROTECTION
EQUIPMENT

DRUG & ALCOHOL
DETECTION

MASKS & FILTERS

FIRE & GAS
DETECTION
SYSTEMS

ENGINEERED
SOLUTIONS

SERVICE,
TRAINING & RENTAL

DIVING
TECHNOLOGY

ENGINEERED SOLUTIONS

PRODUCT	DRIVE	PART NO	PACKAGING UNIT	CATEGORY
Mariner 250 B				
Carrying Trolley			1	
Automatic condensate drain, Incl. 10L collecting tank, final pressure switch off			1	
Automatic condensate drain for units with interstage separator after 1st stage			1	
Separator after 1st stage			1	
Filter system P41			1	
B-Timer (Not possible when SECURUS is used, upgrade possible)			1	
Filling device 4 x 200 bar			1	
Filling device 4 x 300 bar			1	
Switch-over device (SOD) 1x PN 200 bar + 1 x PN 300 bar			1	
Electric Start			1	
Mariner 250 E				
Carrying Trolley			1	
Compressor control Incl. final pressure switch off, automatic condensate drain, 10L collecting tank			1	
Automatic condensate drain for units with interstage separator after 1st stage			1	
Separator after 1st stage			1	
B-KOOL-680S (Standalone)			1	
B-KOOL mounting kit (necessary)			1	
Filter system P41			1	
SECURUS for P41 filter only			1	
B-Timer (Not possible when SECURUS is used, upgrade possible)			1	
Filling device 4 x 200 bar			1	
Filling device 4 x 300 bar			1	
Switch-over device (SOD) 1x PN 200 bar + 1 x PN 300 bar			1	
Mariner 320 B				
Carrying Trolley			1	
Automatic condensate drain, Incl. 10L collecting tank, final pressure switch off			1	
Automatic condensate drain for units with interstage separator after 1st stage			1	
Separator after 1st stage			1	
Filter system P41			1	
Switch-over device (SOD) 2x PN 200 bar + 2x PN 300 bar			1	
Electric Start			1	

ENGINEERED SOLUTIONS

PRODUCT	DRIVE	PART NO	PACKAGING UNIT	CATEGORY
Mariner 320 E				
Carrying Trolley			1	
Compressor control Incl. final pressure switch off, automatic condensate drain, 10L collecting tank			1	
Automatic condensate drain for units with interstage separator after 1st stage			1	
Separator after 1st stage			1	
B-KOOL-680S (Standalone)			1	
B-KOOL mounting kit (necessary)			1	
Filter system P41			1	
SECURUS for P41 filter only			1	
Switch-over device (SOD) 2x PN 200 bar + 2x PN 300 bar			1	



Place You Put Your Faith

ENGINEERED SOLUTIONS

PRODUCT	DRIVE	PART NO	PACKAGING UNIT	CATEGORY
---------	-------	---------	----------------	----------

MINI-VERTICUS - NEW GENERATION!

Economic and compact, the sound-insulated complete station Dräger Mini-Verticus provides up to 250 litres of breathing air per minute.

General

- 3 versions with free air delivery of 150 to 320 L/min
- Stationary
- Vertical design
- Super silent housing
- PLC compressor control

SCOPE OF DELIVERY**Compressor block**

- Micronic intake filter
- Intermediate cooler, after-cooler
- Pressurised oil lubricated
- Intermediate separator after 2nd stage
- Intermediate pressure safety valve

Compressor control

- Semi or fully automatic operation
- Additional slot for Dräger Air Guard
- B-Control Micro

Filter system for pure breathing air

- P41/P61 filter system

Condensate drainage

- Drains automatically during operation and switching on and off

**Filling device for PN 200 or 300 bar:**

Consisting of:

- 4x Self venting filling valves
- 4x Fill hoses (1m long) with DIN G5/8 cylinder connection

Change-over device PN 200/300 bar (optional)

- 2x Filling valve PN 200 and PN 300 bar each
- Switch-over device and safety valve 225 bar

SECURUS monitoring system

- Controls the degree of saturation of the filter cartridges
- Shut down the system when filter replacement is required

MV 200 L/min

MV 200 - PN225 bar	3-phase	6913340	1	532
MV 200 - PN330 bar	3-phase	6913341	1	532
MV 200 - PN 225/330 bar	3-phase	6913342	1	532
MV 200 - PN 330 bar without filling device	3-phase	6913343	1	532

MV 250 L/min

MV 250 - PN225 bar	3-phase	6913730	1	532
MV 250 - PN330 bar	3-phase	6913731	1	532
MV 250 - PN 225/330 bar	3-phase	6913732	1	532
MV 250 - PN 330 bar without filling device	3-phase	6913733	1	532

ENGINEERED SOLUTIONS

PRODUCT	DRIVE	PART NO	PACKAGING UNIT	CATEGORY
MV 320 L/min				
MV 320 - PN225 bar	3-phase	6913734	1	532
MV 320 - PN330 bar	3-phase	6913735	1	532
MV 320 - PN 225/330 bar	3-phase	6913736	1	532
MV 320 - PN 330 bar without filling device	3-phase	6913737	1	532
420 bar is also available (260 and 320 L/min)				
Additional components <i>(prices only valid in conjunction with compressor order)</i>				
Filter upgrade P61 instead of P41			1	532



Place You Put Your Faith

ENGINEERED SOLUTIONS

PRODUCT	DRIVE	PART NO	PACKAGING UNIT	CATEGORY
---------	-------	---------	----------------	----------

PE-MVE

The PE-MVE is Bauer's compact all-in-one solution.

The unit vertically designed and ideal for all applications requiring medium charging rates. Supplied as standard with super silent housing.

General

- 2 versions with free air delivery of 250 and 300 L/min
- Stationary
- Vertical design
- Super silent housing
- Ultra compact dimensions

SCOPE OF DELIVERY

- Micronic intake filter
- Intermediate cooler, after-cooler
- Pressurised oil lubricated
- Intermediate separator after 2nd stage
- Intermediate pressure safety valve
- Silent cabinet
- Automatic Condensate Drain
- Final pressure monitoring
- Phase monitoring
- Semi Automatic , fully auto as option

Compressor control

- Semi or fully automatic operation
- Additional slot for Dräger Air Guard
- B-Control Micro

Filter system for pure breathing air

- P31 filter system
- P42 filter system as option



Condensate drainage

- Drains automatically during operation and switching on and off

Filling device

PN 200 or 300 bar:

Consisting of:

- 2x Self venting filling valves
- 2x Fill hoses (1m long) with DIN G5/8 cylinder connection

SECURUS monitoring system

- Controls the degree of saturation of the filter cartridges
- Shut down the system when filter replacement is required

* SECURUS with P42 filter only

Place You Put Your Faith

PE 250-MVE (250L/min)

PE 250-MVE - PN225 bar	3-phase	6909533	1	532
PE 250-MVE - PN330 bar	3-phase	6909534	1	532

PE 300-MVE (300L/min)

PE 300-MVE - PN225 bar	3-phase	6909535	1	532
PE 300-MVE - PN330 bar	3-phase	6909536	1	532

Additional components (prices only valid in conjunction with compressor order)

Compressor control fully automatic			1	532
B-Timer*			1	532
SECURUS*			1	532
Filter system P42			1	

*B-Timer is available with P31 filter

*SECURUS is only available for P42 filter

ENGINEERED SOLUTIONS

PRODUCT	DRIVE	PART NO	PACKAGING UNIT	CATEGORY
---------	-------	---------	----------------	----------

DRÄGER PE 300 TO 850 VSE (SUPER SILENT VERSION)

Peak delivery up to 850 litres per minute and equipped with automatic control: The new generation of the Dräger PE VSE series has been tailored for your professional applications in industry, fire service and during diving. It guarantees a safe and fast breathing air supply for you with the least control effort.

General

- 5 versions with free air delivery of 300 and 850 L/min
- Stationary - vertical design
- Silent, noise level approx. 72-77 dB(A) at 1m distance
- 3-/4-stage
- Perfect for Scuba diving

SCOPE OF DELIVERY**Compressor block**

- Micronic intake filter
- Intermediate cooler, after-cooler
- 3-stage
- Intermediate separator
- Intermediate pressure safety valve

Compressor control

- Semi or fully automatic operation

Filter system for pure breathing air

- P42 Filter system

Filling device

Filling device can be supplied as option

**Change-over device PN 200/300 bar (optional)**

- 2x Filling valve PN 200 and PN 300 bar each
- Switch-over device and safety valve 225 bar

SECURUS monitoring system

- Controls the degree of saturation of the filter cartridges

Condensate drainage

- Drains automatically during operation and switching on and off

PE 300 VSE

PE 300 VSE - PN 225 bar, with filling device 4x PN 200 bar direct	3-phase	6537010	1	532
PE 300 VSE - PN 330 bar, with filling device 4x PN 300 bar direct	3-phase	6537011	1	532
PE 300 VSE - PN 225/330 bar with filling device 2x PN 200 bar + 2x PN 300 bar direct connection	3-phase	6537012	1	532
PE 300 VSE - PN 330 bar, without filling device	3-phase	6537013	1	532

SECURUS is included.

PE 400 VSE

PE 400 VSE - PN 225 bar, with filling device 4x PN 200 bar direct	3-phase	6537014	1	532
PE 400 VSE - PN 330 bar, with filling device 4x PN 300 bar direct	3-phase	6537015	1	532
PE 400 VSE - PN 225/330 bar with filling device 2x PN 200 bar + 2x PN 300 bar direct connection	3-phase	6537016	1	532
PE 400 VSE - PN 330 bar, without filling device	3-phase	6537017	1	532

SECURUS is included.

ENGINEERED SOLUTIONS

PRODUCT	DRIVE	PART NO	PACKAGING UNIT	CATEGORY
---------	-------	---------	----------------	----------

PE 550 VSE

PE 550 VSE - PN 225 bar, with filling device 4x PN 200 bar direct	3-phase	6537018	1	532
PE 550 VSE - PN 330 bar with filling device 4x PN 300 bar direct	3-phase	6537019	1	532
PE 550 VSE - PN 225/330 bar, with filling device 2x PN 200 bar + 2x PN 300 bar direct connection	3-phase	6537020	1	532
PE 550 VSE - PN 330 bar, without filling device	3-phase	6537021	1	532

SECURUS is included.

PE 700 VSE

PE 700 VSE - PN 225 bar, with filling device 4x PN 200 bar direct	3-phase	6537022	1	532
PE 700 VSE - PN 330 bar, with filling device 4x PN 300 bar direct	3-phase	6537023	1	532
PE 700 VSE - PN 225/330 bar, with filling device 2x PN 200 bar + 2x PN 300 bar direct connection	3-phase	6537024	1	532
PE 700 VSE - PN 330 bar, without filling device	3-phase	6537025	1	532

SECURUS is Included.

PE 850 VSE

PE 850 VSE - PN 330 bar, without filling device	3-phase	6537029	1	532
---	---------	---------	---	-----

SECURUS is included.

Note: PE 320/500/600 VSE are also available.

Additional components	
External air inlet over roof	1
Exhaust air duct	1
Exhaust air duct with cover	1
Condensate collecting tank 40L	1
B-KOOL-680i*	1
B-KOOL mounting kit (necessary)	1
Filling device 4x PN 200 bar hose connection - upgrade option for units without filling device*	1
Filling device 4x PN 200 bar hose connection - upgrade option for units without filling device*	1
Filling device 2x PN 200 bar + 2x PN 300 bar hose connection - upgrade option for units without filling device*	1

* Filling devices above are only available for PE 300/400/550/700

ENGINEERED SOLUTIONS

PRODUCT	DRIVE	PART NO	PACKAGING UNIT	CATEGORY
---------	-------	---------	----------------	----------

DRÄGER PE 250-HE / 300-HE

For over a century, the name Dräger represents safe breathing throughout the world. Dräger compressors provide safe breathing air for industrial applications, the fire services and for diving.

General

- 2 versions with free air delivery of 250 and 300 L/min
- Stationary
- Horizontal design
- Noise level 87 dB(A) at 1m distance
- Open design

SCOPE OF DELIVERY**Compressor block**

- Micronic intake filter
- Intermediate cooler, after-cooler
- 3-stage
- Intermediate separator
- Intermediate pressure safety valve
- Support frame

Compressor control

- Semi automatic operation

Filter system for pure breathing air

- P31 Filter system
- P42 as option

**Condensate drainage**

- Drains automatically during operation and switching on and off

Change-over device PN 200/300 bar (optional)

- 2x Filling valve PN 200 and PN 300 bar each
- Switch-over device and safety valve 225 bar

SECURUS monitoring system (optional)

- Controls the degree of saturation of the filter cartridges

Place You Put Your Faith

PE 250 HE

PE 250 HE - PN 225 bar, with filling device 4x PN 200 bar	3-phase	6533054	1	532
PE 250 HE - PN 330 bar, with filling device 4x PN 300 bar	3-phase	6533055	1	532
PE 250 HE - PN 225/330 bar, with filling device 2x PN 200 bar+2x PN 300 bar with pressure reducer	3-phase	6533056	1	532
PE 250 HE - PN 330 bar, without filling device	3-phase	6533057	1	532

PE 300 HE

PE 300 HE - PN 225 bar, with filling device 4x PN 200 bar	3-phase	6533058	1	532
PE 300 HE - PN 330 bar, with filling device 4x PN 300 bar	3-phase	6533059	1	532
PE 300 HE - PN 225/330 bar, with filling device 2x PN 200 bar+2x PN 300 bar with pressure reducer	3-phase	6533060	1	532
PE 300 HE - PN 330 bar, without filling device	3-phase	6533061	1	532

Additional components

SECURUS for P42 filter only	1
B-Timer	1
Filter upgrade P42 instead of P31	1

ENGINEERED SOLUTIONS

PRODUCT	DRIVE	PART NO	PACKAGING UNIT	CATEGORY
---------	-------	---------	----------------	----------

VERTICUS – NEW GENERATION!

Economic and super silent. The sound-insulated high-pressure compressor station (up to 420 bar)

VERTICUS provides high operational performance and offers safe and reliable breathing air supply for professional applications.

General

- Various versions with free air delivery of 450 to 680 L/min
- Stationary - Vertical design
- Super silent 72 dB(A) at 1m distance
- Suitable for continuous running

SCOPE OF DELIVERY**Compressor block**

- Micronic intake filter
- Pressurised oil lubricated
- Intermediate cooler, after-cooler
- Intermediate separator
- Intermediate pressure safety valve

Compressor Control

- Semi or fully automatic
- B-Control Micro
- Additional slot for external shut down (Dräger Air Guard)

Filter system for pure breathing air

- P61 filter system
- P81 filter system as option

Condensate drainage

- Automatic drainage during operation and when switching on and off

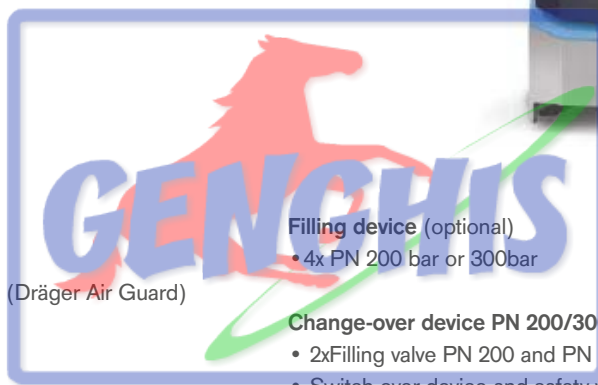

Filling device (optional)

- 4x PN 200 bar or 300bar

Change-over device PN 200/300 bar (optional)

- 2x Filling valve PN 200 and PN 300 bar each
- Switch-over device and safety valve 225 bar

SECURUS monitoring system

- Controls saturation status of the filter cartridges

Place Your Faith

V 450 Silent (450 L/min)

V 450 - PN 225 bar, with filling device	3-phase	6913738	1	532
V 450 - PN 330 bar, with filling device	3-phase	6913739	1	532
V 450 - PN 225/330 bar, with filling device	3-phase	6913740	1	532
V 450 - PN 330 bar, without filling device	3-phase	6913741	1	532

V 540 Silent (540 L/min)

V 540 - PN 225 bar, with filling device	3-phase	6913742	1	532
V 540 - PN 330 bar, with filling device	3-phase	6913743	1	532
V 540 - PN 225/330 bar, with filling device	3-phase	6913744	1	532
V 540 - PN 330 bar, without filling device	3-phase	6913745	1	532

ENGINEERED SOLUTIONS

PRODUCT	DRIVE	PART NO	PACKAGING UNIT	CATEGORY
V 680 Silent (680 L/min)				
V 680 - PN 225 bar, with filling device	3-phase	6913746	1	532
V 680 - PN 330 bar, with filling device	3-phase	6913747	1	532
V 680 - PN 225/330 bar, with filling device	3-phase	6913748	1	532
V 680 - PN 330 bar, without filling device	3-phase	6913749	1	532
V 180-15-5 (680 L/min)				
V 560 - PN 420 bar, without filling device	3-phase	6913783	1	532

Additional components

Filter upgrade P81

Inter stage pressure gauge

Oil Level monitoring

Inter-stage separator after first stage

Control system B-Control II

Compressor control B-APP (B-Link) - available with B-Control Micro

B-KOOL



Place You Put Your Faith

ENGINEERED SOLUTIONS

PRODUCT	DRIVE	PART NO	PACKAGING UNIT	CATEGORY
---------	-------	---------	----------------	----------

DRÄGER PE 300 TO 850 VSE (SUPER SILENT VERSION)

Peak delivery up to 850 litres per minute and equipped with automatic control: The new generation of the Dräger PE VSE series has been tailored for your professional applications in industry, fire service and during diving. It guarantees a safe and fast breathing air supply for you with the least control effort.

General

- 5 versions with free air delivery of 300 and 850 L/min
- Stationary - vertical design
- Silent, noise level approx. 72-77 dB(A) at 1m distance
- 3-/4-stage
- Perfect for Scuba diving

SCOPE OF DELIVERY**Compressor block**

- Micronic intake filter
- Intermediate cooler, after-cooler
- 3-stage
- Intermediate separator
- Intermediate pressure safety valve

Compressor control

- Semi or fully automatic operation

Filter system for pure breathing air

- P42 Filter system

Filling device

Filling device can be supplied as option

**Change-over device PN 200/300 bar (optional)**

- 2x Filling valve PN 200 and PN 300 bar each
- Switch-over device and safety valve 225 bar

SECURUS monitoring system

- Controls the degree of saturation of the filter cartridges

Condensate drainage

- Drains automatically during operation and switching on and off

PE 300 VSE

PE 300 VSE - PN 225 bar, with filling device 4x PN 200 bar direct	3-phase	6537010	1	532
PE 300 VSE - PN 330 bar, with filling device 4x PN 300 bar direct	3-phase	6537011	1	532
PE 300 VSE - PN 225/330 bar with filling device 2x PN 200 bar + 2x PN 300 bar direct connection	3-phase	6537012	1	532
PE 300 VSE - PN 330 bar, without filling device	3-phase	6537013	1	532

SECURUS is Included.

PE 400 VSE

PE 400 VSE - PN 225 bar, with filling device 4x PN 200 bar direct	3-phase	6537014	1	532
PE 400 VSE - PN 330 bar, with filling device 4x PN 300 bar direct	3-phase	6537015	1	532
PE 400 VSE - PN 225/330 bar with filling device 2x PN 200 bar + 2x PN 300 bar direct connection	3-phase	6537016	1	532
PE 400 VSE - PN 330 bar, without filling device	3-phase	6537017	1	532

SECURUS is Included.

ENGINEERED SOLUTIONS

PRODUCT	DRIVE	PART NO	PACKAGING UNIT	CATEGORY
---------	-------	---------	----------------	----------

PE 550 VSE

PE 550 VSE - PN 225 bar, with filling device 4x PN 200 bar direct	3-phase	6537018	1	532
PE 550 VSE - PN 330 bar with filling device 4x PN 300 bar direct	3-phase	6537019	1	532
PE 550 VSE - PN 225/330 bar, with filling device 2x PN 200 bar + 2x PN 300 bar direct connection	3-phase	6537020	1	532
PE 550 VSE - PN 330 bar, without filling device	3-phase	6537021	1	532

SECURUS is Included.

PE 700 VSE

PE 700 VSE - PN 225 bar, with filling device 4x PN 200 bar direct	3-phase	6537022	1	532
PE 700 VSE - PN 330 bar, with filling device 4x PN 300 bar direct	3-phase	6537023	1	532
PE 700 VSE - PN 225/330 bar, with filling device 2x PN 200 bar + 2x PN 300 bar direct connection	3-phase	6537024	1	532
PE 700 VSE - PN 330 bar, without filling device	3-phase	6537025	1	532

SECURUS is Included.

PE 850 VSE

PE 850 VSE - PN 330 bar, without filling device	3-phase	6537029	1	532
---	---------	---------	---	-----

SECURUS is Included.

Note: PE 320/500/600 VSE are also available.

Additional components (prices only valid in conjunction with compressor order)

External air inlet over roof	1
Exhaust air duct	1
Exhaust air duct with cover	1
Condensate collecting tank 40L	1
B-KOOL-680i*	1
B-KOOL mounting kit (necessary)	1
Filling device 4x PN 200 bar hose connection - upgrade option for units without filling device*	1
Filling device 4x PN 200 bar hose connection - upgrade option for units without filling device*	1
Filling device 2x PN 200 bar + 2x PN 300 bar hose connection - upgrade option for units without filling device*	1

* Filling devices above are only available for PE 300/400/550/700

ENGINEERED SOLUTIONS

PRODUCT	DRIVE	PART NO	PACKAGING UNIT	CATEGORY
---------	-------	---------	----------------	----------

PE 300 TO 850 VE (OPEN VERSION)

Peak delivery up to 850 litres per minute and equipped with automatic control: The new generation of the Dräger PE VSE series has been tailored for your professional applications in industry, fire service and during diving. It guarantees a safe and fast breathing air supply for you with the least control effort.

General

- 5 versions with free air delivery of 300 and 850 L/min
- Stationary - vertical design
- Open design
- 3-/4-stage

SCOPE OF DELIVERY**Compressor block**

- Micronic intake filter
- Intermediate cooler, after-cooler
- 3-stage
- Intermediate separator
- Intermediate pressure safety valve

Compressor control

- Semi or fully automatic operation

Filter system for pure breathing air

- P42 Filter system

Filling device

Filling device can be supplied as option

**Change-over device PN 200/300 bar (optional)**

- 2x Filling valve PN 200 and PN 300 bar each
- Switch-over device and safety valve 225 bar

SECURUS monitoring system

- Controls the degree of saturation of the filter cartridges

Condensate drainage

- Drains automatically during operation and switching on and off

PE 300 VE

PE 300 VE - PN 225 bar, with filling device 4x PN 200 bar direct	3-phase	6536990	1	532
PE 300 VE - PN 330 bar, with filling device 4x PN 300 bar direct	3-phase	6536991	1	532
PE 300 VE - PN 225/330 bar with filling device 2x PN 200 bar + 2x PN 300 bar direct connection	3-phase	6536992	1	532
PE 300 VSE - PN 330 bar, without filling device	3-phase	6536993	1	532

SECURUS is Included.

PE 400 VE

PE 400 VE - PN 225 bar, with filling device 4x PN 200 bar direct	3-phase	6536994	1	532
PE 400 VE - PN 330 bar, with filling device 4x PN 300 bar direct	3-phase	6536995	1	532
PE 400 VE - PN 225/330 bar with filling device 2x PN 200 bar + 2x PN 300 bar direct connection	3-phase	6536996	1	532
PE 300 VE - PN 330 bar, without filling device	3-phase	6536997	1	532

SECURUS is Included.

ENGINEERED SOLUTIONS

PRODUCT	DRIVE	PART NO	PACKAGING UNIT	CATEGORY
PE 550 VE				
PE 550 VE - PN 225 bar, with filling device 4x PN 200 bar direct	3-phase	6536998	1	532
PE 550 VE - PN 330 bar with filling device 4x PN 300 bar direct	3-phase	6536999	1	532
PE 550 VE - PN 225/330 bar, with filling device 2x PN 200 bar + 2x PN 300 bar direct connection	3-phase	6537000	1	532
PE 300 VE - PN 330 bar, without filling device	3-phase	6537001	1	532

SECURUS is Included.

PE 700 VE

PE 700 VE - PN 225 bar, with filling device 4x PN 200 bar direct	3-phase	6537002	1	532
PE 700 VE - PN 330 bar, with filling device 4x PN 300 bar direct	3-phase	6537003	1	532
PE 700 VSE - PN 225/330 bar, with filling device 2x PN 200 bar + 2x PN 300 bar direct connection	3-phase	6537004	1	532
PE 700 VE - PN 330 bar, without filling device	3-phase	6537005	1	532

SECURUS is Included.

PE 850 VE

PE 850 VE - PN 330 bar, without filling device	3-phase	6537009	1	532
--	---------	---------	---	-----

SECURUS is Included.

Note: PE 320/500/600 VE are also available.

Additional components (prices only valid in conjunction with compressor order)

External air inlet over roof	1
Exhaust air duct	1
Exhaust air duct with cover	1
Condensate collecting tank 40L	1
B-KOOL-680S*	1
B-KOOL mounting kit (necessary)	1
Filling device 4x PN 200 bar hose connection - upgrade option for units without filling device*	1
Filling device 4x PN 200 bar hose connection - upgrade option for units without filling device*	1
Filling device 2x PN 200 bar + 2x PN 300 bar hose connection - upgrade option for units without filling device*	1

* Filling devices above are only available for PE 300/400/550/700

ENGINEERED SOLUTIONS

PRODUCT	PART NO	PACKAGING UNIT	CATEGORY
---------	---------	----------------	----------

B-KOOL REFRIGERANT TYPE DRYER

General

- 90-420 bar
- Up to 11 times longer life for filter cartridges
- Up to 700 L/min



B-KOOL 680i	200-240 VA, 50/60 Hz (single phase)	TBA	1	532
B-KOOL 680s	200-240 VA, 50/60 Hz (single phase)	TBA	1	532

* B-KOOL 680i for installation on top of VERTICUS 5 (Super silent housing required)

* B-KOOL 680s for separate installation near the compressor unit

Mounting kit for 680i				
for compressor Verticus 5 (P81)			1	
for compressor Dräger DE VSE (P41/P61)			1	
Mounting kit for 680s (standalone)				
for compressor Verticus 5 (P81)			1	
for compressor Dräger DE VSE (P41/P61)			1	
for Mini-Verticus			1	
for Mariner 200/250/320			1	

ENGINEERED SOLUTIONS

PRODUCT	PART NO	PACKAGING UNIT	CATEGORY
---------	---------	----------------	----------

COMPRESSOR BLOCKS

Bauer Compressor blocks for Air 90-500 bar.

- 85-610 L/min
- 2.2-15 KW

Scope of supply

- Compressor block with
- Micronic type suction filter
- Intermediate and final cooler
- Intermediate separators from 2nd stage
- Intermediate safety valves
- Flywheel for v-belt drive
- Crank case with oil drain valve

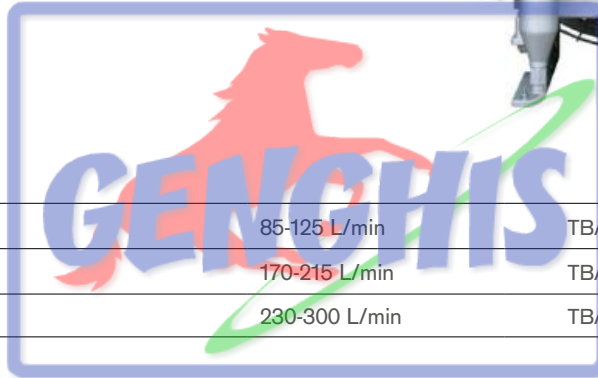
**90-350 bar**

IK 100 (V001)	85-125 L/min	TBA	1	532
IK 120 (V001)	170-215 L/min	TBA	1	532
IK 12.14 (V001)	230-300 L/min	TBA	1	532

350-420 bar

IK 100-420 (V001)	100 L/min	TBA	1	532
IK 12.14 (V001)	230-290 L/min	TBA	1	532

350-500 bar

IK 15.11 (V001)	310-420 L/min	TBA	1	532
IK 18.1 (V001)	510 L/min	TBA	1	532

Place You Put Your Faith

ENGINEERED SOLUTIONS

PRODUCT	PART NO	PACKAGING UNIT	CATEGORY
---------	---------	----------------	----------

AIR PURIFICATION (FILTER) SYSTEM

- 90-350 bar
- Up to 1,000 L/min
- High Pressure Purification System

Scope of supply

- Filter housing(s), complete with 1 set of filter cartridge(s)
- Non-return valve with gauge and venting valve
- Combined pressure maintaining / non-return valve
- Screw fittings and 0,5 m piping for connecting components
- Filter key for cartridge replacement

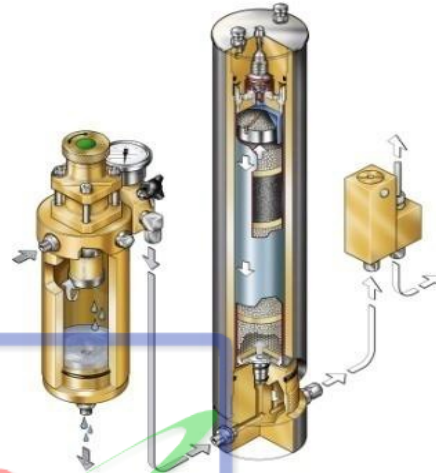

Standard Scope of supply does not include a safety valve.
Additional filter for purification system with CO conversion available

Mounting kit for 680s (standalone)			
Mounting Kit P21	TBA	1	532
Mounting Kit P41	TBA	1	532
Mounting Kit P61	TBA	1	532
Mounting Kit P81	TBA	1	532
Mounting kit for 680s (standalone)			
Switch-Over Device	TBA	1	532
SECURUS FILTER MONITORING FOR P42, P41,P61,P81,P101	TBA	1	532

CO CONVERSION CAN BE QUOTED ON REQUEST.

ENGINEERED SOLUTIONS

PRODUCT	PART NO	PACKAGING UNIT	CATEGORY
---------	---------	----------------	----------

DRÄGER AIR GUARD 4200/4500/5200/5500

Dräger Air Guard is a compact system constantly monitoring the purity of compressed air. Even with the slightest contamination the Air Guard 4200/4500 or 5500 issues a reliable warning.

Reliable monitoring

- Continuous and fully automated test and monitoring of breathing air
- Automatic alarm if the limits are exceeded
- High precision sensors
- CO₂ measuring range: 0-2,000 ppm
- CO measuring range: 0-100 ppm
- Air Guard 4200: 100-240 V AC
- Air Guard 4500: 120-500 V AC
- Air Guard 5500: 120-500 V AC
- Operating pressure: 10-350 bar

Calibrated version

- Air Guard 4500 and 5500 have an additional flow sensor (logging the sensor value is possible by using a configuration software)
- Air Guard 5500 enables an extended measuring utilising a 3rd sensor such as O₂ or H₂S



Air Guard 4200	6535691	1	531
Air Guard 4500	6535690	1	531
Air Guard 5200	6537131	1	531
Air Guard 5500	6537250	1	531

Hoses for older compressors models

Intake hose complete for open systems:

K100-K120 (with intake filter 013758) manufactured prior to 4/2004	60/32	6598086	1	998
K15 (with intake filter 056372)				

Intake hose complete for silent systems:

K100-K120 designed as above	60/25	6598087	1	998
-----------------------------	-------	---------	---	-----

Replacement filter cartridge

Filter cartridge Incl. 10 pcs water disinfection tablets for 10 litres water each		6532440	1	998
Sterilisation tablets 40 pcs		TBA	1	998

ENGINEERED SOLUTIONS

PRODUCT	PART NO	PACKAGING UNIT	CATEGORY
---------	---------	----------------	----------

FILLING SPEED CONTROL (FSC)

System module to guarantee the filling speed in accordance with the manufacturer specification for the compressed-air cylinders (20 – 50 bar/min).

Scope of supply:

- Pilot operated by a PLC system (24V DC)
- Tube connection 8mm
- 2x pressure sensors for inlet/outlet
- Filter 25 µm at inlet



DFSC-300

6536600

1

532

SAFE FILLING SYSTEM (DSF-ECO) W/O ELECTRONIC CONTROL

DSF ECO is a high pressure safety filling cabinet for breathing air cylinders. Unit must be directly fed by a compressor and cannot be used with a storage bank.

Place You Put Your Faith

- Two lockable sliding doors
- Maximum 6 fill holes



DSF 6x PN 300 bar filling hoses

TBA

1

532

DSF 3x PN 200 bar+ 3x PN 300 bar filling hoses

TBA

1

532

ENGINEERED SOLUTIONS

PRODUCT	PART NO	PACKAGING UNIT	CATEGORY
---------	---------	----------------	----------

SAFE FILLING SYSTEM (DSF) WITH ELECTRONIC CONTROL

The Dräger DSF safety filling system is designed for the safe filling of breathing air cylinders, combined with a high pressure compressor, it enables the filling of up to 6 cylinders with pressures of 200 or 300 bar.

- Two lockable sliding doors
- Can be equipped with maximum 6 outlets
- Automatic change-over unit
- Touch screen interface (not with the pneumatic version)
- Fill speed control valve to keep the fill speed between 20-50 bar/min
- to be used with bank storage
- Solenoid valve version with no filling speed control
- to be used with compressor

**Fill Speed Control Version**

DSF 6x PN 300 bar filling hoses	6532955	1	532
DSF 3x PN 200 bar+ 3x PN 300 bar filling hoses	6534446	1	532

Solenoid Valve Version

DSF 6x PN 300 bar Filling hoses	6598739	1	532
DSF 3x PN 200 bar + 3x PN 300 bar filling hoses	6598740	1	532

Additional components

Fixation plate Including cylinder straps (set of 6 pcs)		1	
---	--	---	--

ENGINEERED SOLUTIONS

PRODUCT	PART NO	PACKAGING UNIT	CATEGORY
---------	---------	----------------	----------

SAFETY FILLING CABINETS - MADE IN GERMANY

- Armoured Steel cabinets, suitable for 225mm diameter breathing air cylinders
- max inlet pressure 350 bar
- Adjustable flow restrictor
- Self-venting lever filling valves for each outlet
- Emergency cut off switch
- High pressure solenoid valve
- Safety door lock mechanism with control light
- Start / Stop buttons



Type 1 - Single Pressure

LW-2S	(2x PN200 bar or 2x PN300 bar)	TBA	1	531
LW-3S	(3x PN200 bar or 3x PN300 bar)	TBA	1	531

Type 1 - Dual Pressure

LW-2S	(2x PN200 bar and 2x PN300 bar)	TBA	1	531
LW-3S	(3x PN200 bar and 3x PN300 bar)	TBA	1	531

Maximum cylinder diameter: 220mm

Place You Put Your Faith



Type 2 : Units with five or seven filling slots

Type 2 - Single Pressure

LW-5S	(5x PN200 bar or 5x PN300 bar)	TBA	1	531
LW-7S	(7x PN200 bar or 7x PN300 bar)	TBA	1	531

Type 2 - Dual Pressure

LW-5S	Configure to order	TBA	1	531
LW-7S	Configure to order	TBA	1	531

Maximum cylinder diameter: 163mm

Dräger Region South East Europe | Rev: 0 | Subject to modification! | www.draeger.com

Place You Put Your Faith

PORTABLE
GAS DETECTION

PERSONAL
PROTECTION
EQUIPMENT

DRUG & ALCOHOL
DETECTION

MASKS & FILTERS

FIRE & GAS
DETECTION
SYSTEMS

ENGINEERED
SOLUTIONS

SERVICE,
TRAINING & RENTAL

DIVING
TECHNOLOGY

ENGINEERED SOLUTIONS

PRODUCT	PART NO	PACKAGING UNIT	CATEGORY
---------	---------	----------------	----------

AIR GUARD 4200/4500/5200/5500

Dräger Air Guard is a compact system constantly monitoring the purity of compressed air. Even with the slightest contamination the Air Guard 4200/4500 or 5500 issues a reliable warning.

Reliable monitoring

- Continuous and fully automated test and monitoring of breathing air
- Automatic alarm if the limits are exceeded
- High precision sensors
- CO₂ measuring range: 0-2,000 ppm
- CO measuring range: 0-100 ppm
- Air Guard 4200: 100-240 V AC
- Air Guard 4500: 120-500 V AC
- Air Guard 5500: 120-500 V AC
- Operating pressure: 10-350 bar

Calibrated version

- Air Guard 4500 and 5500 have an additional flow sensor (logging the sensor value is possible by using a configuration software)
- Air Guard 5500 enables and extended measuring utilising a 3rd sensor such as O₂ or H₂S



Air Guard 4200	6535691	1	531
Air Guard 4500	6535690	1	531
Air Guard 5200	6537131	1	531
Air Guard 5500	6537250	1	531

PURACON

Digital breathing air monitor with display and sensor to determine the residual water content in mg / m³. Additionally 3 coloured LEDs visually provide the saturation level of the final filter cartridge. Wall mounted independently of the high pressure breathing air compressor. Built-in sensor.

Features:

- Display unit for wall mounting 120x120x60mm with power cable 1200mm (230V) and plugs and Sensor cable 2000mm, languages en, de, es and adjustable 3-color LED display
- Programmable circuit, Green <20 mg / m³; m³ yellow 20-25 mg / m³; red > 25mg / m³
- Maintenance-free sensor
- Maximum operating pressure 420 bar
- Automatic shutdown of the compressor when the limits are exceeded
- Stainless steel sensor housing (Ø 45x95mm) with G1 / 4 inlet and outlet



PURACON	6564988	532
---------	---------	-----

ENGINEERED SOLUTIONS

PRODUCT	PART NO	PACKAGING UNIT	CATEGORY
---------	---------	----------------	----------

AEROTEST SIMULTAN HP

The Dräger Aerotest Simultan HP is used to determine the quality of the breathing air supplied from a high pressure system (e.g. compressor or compressed gas cylinders).

Tested breathing air

- To determine the quality of the breathing air
- Based on Dräger tubes®
- Detecting and measuring toxic gases
- Quantifying various potential
- individual or simultaneous detection possible

Quick and easy to use

- G 5/8 connection
- Quick check - precise measuring results after 5 minutes

Oil impactor

- tests compressed air for oil aerosols (also synthetic oils)



Dräger Aerotest Simultan HP without Dräger tubes® and oil impactor	6525937	1	531
Dräger Aerotest Simultan HP complete	6525951	1	531

Place You Put Your Faith

ENGINEERED SOLUTIONS

PRODUCT	PART NO	PACKAGING UNIT	CATEGORY
---------	---------	----------------	----------

DRÄGER AEROTEST NAVY

The Dräger Aerotest Navy is used to determine the quality of the breathing air supplied from a high pressure system (e.g. compressor or compressed gas cylinders).

Tested breathing air

- To determine the quality of the breathing air
- Based on Dräger tubes®
- Detecting and measuring toxic gases
- Quantifying various potential
- individual or simultaneous detection possible
- Oxygen concentration of up to 5 % vol. can be measured

Quick and easy to use

- G 5/8 connection
- Quick check - precise measuring results after 5 minutes



Dräger Aerotest Navy without Dräger tubes®	6525970	1	531
Dräger Aerotest Navy complete	6525960	1	531

Place You Put Your Faith

ENGINEERED SOLUTIONS

PRODUCT	PART NO	PACKAGING UNIT	CATEGORY
---------	---------	----------------	----------

OXYTEST 2000

Portable O₂ measuring device for measuring the oxygen concentration in breathing air and oxygen/gas mixtures.

For the operation of:

- Mixed gas cylinder filling systems
- Mixed gas boosters

Standard oxygen/gas mixtures required depend on diving depth:

- 60 vol. % O₂ / 40 vol. % N₂
- 50 vol. % O₂ / 50 vol. % N₂
- 40 vol. % O₂ / 60 vol. % N₂
- 32,5 vol. % O₂ / 67,5 vol. % N₂

Quick and easy to use

- Via push-in connector
- X-am 5000 indicates the evaluated oxygen concentration



Dräger OxyTest 2000, G3/4	6530487	1	531
Dräger OxyTest 2000, W21.8 x 11/14	6568334	1	531
Dräger OxyTest 2000, M24x2 Nitrox	6568335	1	531
Dräger OxyTest 2000, CGA-540	6568336	1	531

ENGINEERED SOLUTIONS

PRODUCT	PART NO	PACKAGING UNIT	CATEGORY
---------	---------	----------------	----------

OXYGEN BOOSTER (DOB) 200 / 300

The Dräger Oxygen Booster DOB is a complete oxygen transfer station for filling oxygen from storage cylinders into device cylinders and due to its compact design it only occupies a little space.

Versatile area of application

- Compact in size
- For all operating locations where filling high pressure oxygen cylinder is required
- Comprising filling valves and pressure gauges
- Multiple outlets
- Electrical drive Easy operation
- Ergonomically designed

Nominal pressure: PN 200/300

Max. operating pressure: 220/330

Power supply: 3-phase

Filling connections:

4x PN 200 or PN 300 or 2x PN 200 + 2x PN 300



DOB 200, G3/4 (1x) + M24x2 (3x) PN 200 bar	6533648	1	531
DOB 200, M24x2 (4x) PN 200 bar	6559957	1	531
DOB 200, G3/4 (4x) PN 200 bar	6526750	1	531
DOB 200, W21.8 (4x) PN 200 bar	6527350	1	531
DOB 200/300, G3/4 (2x) + Oxy-SR (2x) PN 200 bar	6526430	1	531
DOB 300, Oxy-SR (4x) PN 300 bar	6526915	1	531

ENGINEERED SOLUTIONS

PRODUCT	PART NO	PACKAGING UNIT	CATEGORY
---------	---------	----------------	----------

OXYGEN BOOSTER DOB-M/T

The Dräger Oxygen Booster DOB-M (mobile version) and the Dräger DOB-T (table version) are compact, portable filling stations which ensure the effective transfer of oxygen up to 300 bar from storage cylinders into device cylinders.

Versatile area of application

- Easy to transport
- For all operating locations where filling high pressure oxygen cylinder is required
- Comprising filling valves and pressure gauges
- Multiple outlets
- Electrical drive Easy operation
- Ergonomically designed

Nominal pressure: PN 200/300
 Max. operating pressure: 220/330
 Power supply: 3-phase

Filling connections:
 4 x PN 200 or 4 x PN 300



DOB-M, G3/4, 4x PN 200 bar	6526900	1	531
DOB-M, W21.8, 4x PN 200 bar	6526802	1	531
DOB-T, G3/4, 4x PN 200 bar	6527200	1	531
DOB-T, W21.8, 4x PN 200 bar	6527195	1	531
DOB-T Niro (NSN/BUND), G3/4, 4x PN 200 bar	6532680	1	531
DOB-T, Oxy-SR, 4x PN 300 bar	6530479	1	531
DOB-T, G3/4 (1x PN 200 bar) + M24x2 (3x PN 200 bar)	6536607	1	531
DOB-T, M24x2, 4x PN 200 bar	6536608	1	531

ENGINEERED SOLUTIONS

PRODUCT	DRIVE	PART NO	PACKAGING UNIT	CATEGORY
---------	-------	---------	----------------	----------

OXYGEN BOOSTER (DOB) – HG/HW/HT 200

Small, robust, effective: The mobile Dräger Oxygen Booster DOB-H is a single stage, double-acting piston pump which is essential for all applications where high pressure oxygen must be available in device cylinders irrespective of the available power supply.

**Versatile area of application**

- Easy to transport and flexible in use
- Purely mechanical, no need to power supply
- Ergonomically designed
- Weight: approx. 50 Kg

DOB-HG, G3/4, PN 200 bar Including aluminium transport case	6530600	1	531
DOB-HT, G3/4, PN 200 bar Including plastic roll-up case	6531300	1	531
DOB-HW, G3/4, PN 200, wall mounted version	6531000	1	531

Note: No Hose Is Included.

Place You Put Your Faith

ENGINEERED SOLUTIONS

PRODUCT	PART NO	PACKAGING UNIT	CATEGORY
---------	---------	----------------	----------

DRÄGER OXYGEN BOOSTER DOB-200-ECO

The Dräger Oxygen Booster DOB is a very compact size oxygen transfer station for filling oxygen cylinders from storage cylinders.

Versatile area of application

- Compact in size
- For all operating locations where filling high pressure oxygen cylinder is required
- Comprising filling valves and pressure gauges
- Multiple outlets
- Electrical drive Easy operation
- Ergonomically designed

Nominal pressure: PN 200/300

Max. operating pressure: 220/330

Power supply: single phase

Filling connections: 4x PN 200 (refer to the filling panels)



DOB 200 (G 3/4) ECO	6903800	1	531
Filling Panels			
Filling panel O2 PS220 G3/4a-G3/4i(4x)	6905280	1	531
Filling panel O2 PS220 G3/4a-CGA540i(4x)	6905281	1	531
Filling panel O2 PS220 G3/4a-W21.8xi(4x)	6905282	1	531
Filling panel O2 PS220 G3/4a-M24x2i(4x)	6905283	1	531
Filling panel O2 PS220 G3/4a-M26x2a(4x)	6905284	1	531
Filling panel O2 PS220 G3/4a-BS341No3i(4x)	6905343	1	531
Hoses			
Hose O2 PS220 1.5m G3/4-G3/4i	6530017	1	531
Hose O2 PS220 1.5m CGA540-G3/4i	6568198	1	531
Hose O2 PS220 1.5m W21.8xi-G3/4i	6568201	1	531
Hose O2 PS220 1.5m M24x2i-G3/4i	6568204	1	531
Hose O2 PS220 1.5m M26x2a-G3/4i	6568207	1	531
Hose O2 PS220 1.5m BS341No3-G3/4i	6568199	1	531
Hose O2 PS220 3m G3/4i-G3/4i	6568196	1	531
Hose O2 PS220 3m CGA540i-G3/4i	6568255	1	531
Hose O2 PS220 3m W21.8xi-G3/4i	6568202	1	531
Hose O2 PS220 3m M24x2i-G3/4i	6568205	1	531
Hose O2 PS220 3m M26x2a-G3/4i	6568208	1	531
Hose O2 PS220 3m BS341No3-G3/4i	6568256	1	531
Hose O2 PS220 5m G3/4i-G3/4i	6568197	1	531
Hose O2 PS220 5m CGA540i-G3/4i	6568200	1	531
Hose O2 PS220 5m W21.8xi-G3/4i	6568203	1	531
Hose O2 PS220 5m W21.8xi-G3/4i	6568206	1	531
Hose O2 PS220 5m M24x2i-G3/4i	6568209	1	531
Hose O2 PS220 5m M26x2a-G3/4i	6568257	1	531

ENGINEERED SOLUTIONS

PRODUCT	PART NO	PACKAGING UNIT	CATEGORY
---------	---------	----------------	----------

AIR-BOOSTER (DAB) – T

The Dräger Air-Booster DAB-T (table version) is a compact and portable transfer station for transferring breathable compressed air and nitrogen. The basic device is the Oxygen Booster DOB-T which has been modified for breathing air.

Features:

- Electrical drive
- Ergonomically designed
- Simultaneously can fill multiple cylinders
- Compact in size with carrying handles



DAB-T, G5/8, 4x PN 200 bar	6530505	1	531
DAB-T Navy, 4x PN 200 bar	6532770	1	531
DAB - T Niro, G5/8, 4x PN 200 bar	6532690	1	531

CO2 ABSORPTION CARTRIDGES

The CO2 absorption cartridge is packed in a transparent plastic container and can be used for different CO2 absorption systems/applications.

- Filled with DrägerSorb 400 S (4.7 Kg)
- Optimised packing density
- High abrasion resistance
- Large active inner surface

Place You Put Your Faith



CO2 absorption cartridge	CH16720	1	531
--------------------------	---------	---	-----

DRÄGER SODA LIME DIVESORB® S DRUM

DiveSorb® S in a drum for filling CO2 absorption systems and soda lime cartridges.



Soda lime DiveSorb® S drum (138 kg)	6532367	1	531
-------------------------------------	---------	---	-----

ENGINEERED SOLUTIONS

PRODUCT	PART NO	PACKAGING UNIT	CATEGORY
---------	---------	----------------	----------

OXYGEN GENERATORS

The chemical oxygen generator can be used for standard and emergency oxygen supplies.

- Can be used for oxygen supply in confined spaces.
- Supplies 80 to 1500 litres medical pure oxygen (depending on the size)

Use:

- Pulling the safety pin triggers, the priming device and oxygen production begins.
- Once started, it cannot be interrupted.



Oxygen generator 80 L	6530390	1	531
Oxygen generator 160 L	6530510	1	531
Oxygen generator 250 L	6530511	1	531
Oxygen generator 300 L	6530512	1	531
Oxygen generator 1500 L	6535400	1	531

SODALIME CURTAIN

SodaLime Curtain, for use in confined spaces to reduce the CO₂ contents in the atmosphere without a power supply.

- Easy to use
- Special fabric from GRP and PVC; breathable and water-repellent
- Reusable for several times
- Soda lime DrägerSorb® 400 S
- High CO₂ absorption capacity
- Low dust development due to high abrasion resistance
- Increase of absorption performance possible by increasing the relative humidity



Two SodaLime curtains Incl. 18 kg soda lime	6902499	1	531
Replacement SodaLime curtain	6531801	1	531

ENGINEERED SOLUTIONS

PRODUCT	PART NO	PACKAGING UNIT	CATEGORY
---------	---------	----------------	----------

FILTER PROTECTION SYSTEM VS-2

The Dräger VS-2 filter protection system offers protection against irritant gases (CN/CS) as well as solid, liquid and gaseous contamination in the breathing air. The outside air is cleaned through a 3-stage filter system and directed into the sealed room. In addition, the system creates a protective positive pressure in the room.

- Can be installed in any position
- Stainless Steel housing
- Suitable for external use
- Compact and ready to be connected to the system
- Maintenance free fan
- Adjustable air volume
- Quick filter replacement without tools
- Selection of activated carbon filters for different applications



Filter system VS-2	6526500	1	531
--------------------	---------	---	-----

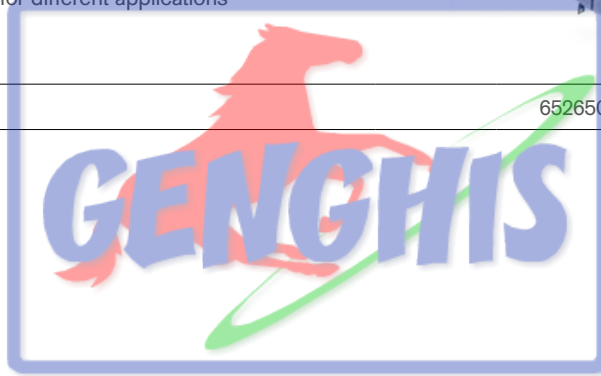

Place You Put Your Faith

ENGINEERED SOLUTIONS

PRODUCT	PART NO	PACKAGING UNIT	CATEGORY
---------	---------	----------------	----------

NITROX NAVY GAS MIXING UNIT

The Dräger Nitrox Navy 200 is a manually operated unit for mixing and filling of nitrox gases consisting of oxygen (up to 200 bar) and breathing air (200 bar).

Functions of the Dräger Nitrox 200 Navy:

- Supply: medical oxygen and high pressure breathing air
- Filling diving cylinders with oxygen or air
- For filling Nitrox cylinders up to 12L / 200 bar
- Large Nitrox cylinders can be filled by using a fill hose



Dräger Nitrox 200 Navy

6530021

1

531

WORKSHOP SYSTEMS

In addition to standard products Dräger offer workshop systems designed to your individual requirements ensuring efficient workflow, great care and servicing the equipment.

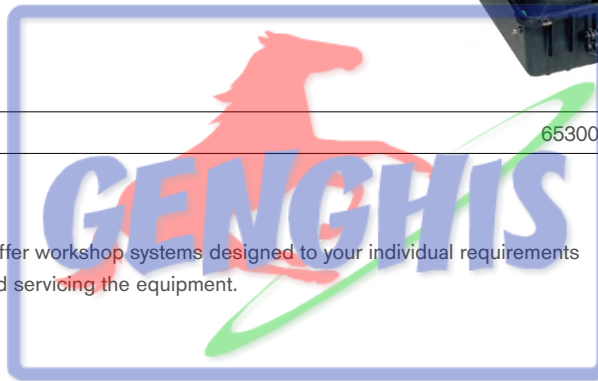

Place You Put Your Faith



ENGINEERED SOLUTIONS

PRODUCT	PART NO	PACKAGING UNIT	CATEGORY
---------	---------	----------------	----------

MASK DRYING CABINET MTS

for drying respiratory protective masks and components.

Features and benefits:

- Stainless steel housing
- Insulated drying cabinet
- High-performance radial fan for short drying periods
- Simple loading due to removable baskets
- Drip basin to collect residual moisture
- Low maintenance

**Desktop versions**

MTS 2, 2 baskets, for approx. 12 masks	6573050	1	487
MTS 4, 4 baskets, for approx. 24 masks	6573051	1	487
MTS 6, 6 baskets, for approx. 36 masks	6573052	1	487
Standalone versions			
MTS 8 SM, 8 baskets, for approx. 72 masks	6573053	1	487
MTS 10 SM, 10 baskets, for approx. 90 masks	6573054	1	487

HOSE DRYING SYSTEM

Specially designed for drying components of closed-circuit breathing apparatuses, breathing bag, breathing air cooler, corrugated hose and refill cartridge.

Features and benefits:

- stainless steel housing
- high-performance radial fan for short drying periods
- easy to use
- low maintenance



Hose drying System SAT 6 with 12 connections for simultaneous drying of components of 3 closed-circuit breathing apparatuses	6570185	1	487	\$9,723.00
--	---------	---	-----	------------

Accessories required

Adaptor for breathing bag	R34623	1	240	\$226.00
Adaptor for breathing cooler	R34624	1	280	\$264.00
Adaptor for breathing corrugated hose	R34625	1	280	\$264.00
Adaptor for breathing cartridge	R34626	1	280	\$264.00

ENGINEERED SOLUTIONS

PRODUCT	PART NO	PACKAGING UNIT	CATEGORY
---------	---------	----------------	----------

COMBICLEAN 130/180/250/340

The Dräger CombiClean product family is specially designed for the requirements of fire brigades.

Washing machines for masks, chemical protection suits and firefighter clothes, also made of Nomex® or Kermel®

Features and benefits:



- Compass Control® micro-processor control with
- Maximum of 40 standard programs, optionally 10 other programs
- Dräger washing program for respiratory protective masks
- washing programs for firefighter clothes also made of Nomex® and Kermel®
- electronic temperature control for safe disinfecting
- economic due to low operating costs, extreme durability and reliability
- normal speed machines w/ g-factor 100, high-speed machines w/ g-factor 300-425
- electrical heating
- electric connection 400 V, 3n, ac 50Hz (other voltages on request)
- correct spinning force due to dynamic balancing system tm

**CombiClean normal speed**

CombiClean 130, 13x masks, 1x CPS, 3x jackets, 14 Kg cloth	7904016	1	487
CombiClean 180, 18x masks, 1x CPS, 3x jackets, 20 Kg cloth	7904000	1	487
CombiClean 250, 25x masks, 2x CPS, 7x jackets, 28 Kg cloth	7904023	1	487
CombiClean 340, 33x masks, 3x CPS, 9x jackets, 34 Kg cloth	7904001	1	487

Base is available as accessory.

ENGINEERED SOLUTIONS

PRODUCT	PART NO	PACKAGING UNIT	CATEGORY	
CombiClean high speed				
CombiClean 55, 5x masks, 6 Kg cloth	7904007	1	487	
CombiClean 55 LP with lye pump, 5x masks, 6 Kg cloth	7904006	1	487	
CombiClean 65, 6x masks, 1x jackets, 7 Kg cloth	7904003	1	487	
CombiClean 75, 8x masks, 2x jackets, 8 Kg cloth	7904030	1	487	
CombiClean 105, 10x masks, 3x jackets, 11 Kg cloth	7904008	1	487	
CombiClean 135, 13x masks, 1x CPS, 4x jackets, 14 Kg cloth	7904012	1	487	
CombiClean 185, 18x masks, 1x CPS, 5x jackets, 20 Kg cloth	7904017	1	487	
CombiClean 245, 24x masks, 2x CPS, 6x jackets, 27 Kg cloth	7904022	1	487	
Base is available as accessory.				
Accessories				
Set of three dosage pumps for liquid detergents with suction lances	7904019	1	487	
Washing bag - reversible colour showing masks status (to be washed/ready for use) - Straps with stopper on both sides of the bag - made of polyester/cotton Dimensions: L360 x W340 mm		7904013	1	487
Washing bag for masks, optimal protection, high quality Tecafort® material, orange		7904011	1	487
Washing bag for breathing apparatus frame - reversible bag: colour shows mask status (to be washed / ready for use) - straps with stopper on both sides of the bag - made of polyester / cotton Dimensions: L800 x W550 mm		6570184	1	487
Visor protection bag for CPS - Optimal protection due to increased lining - High-quality Tecafort® material, orange Dimensions: L560 x W450 mm		6570003	1	487
Protective foil	TBA	1	160	
Pad for helmet	TBA	1	285	
Visior	TBA	1	710	

ENGINEERED SOLUTIONS

PRODUCT	PART NO	PACKAGING UNIT	CATEGORY
---------	---------	----------------	----------

COMBIDRY

The CombiDry product family is specially designed for the requirements of fire brigades. Tumble dryer for drying of firefighter's clothing and for treatment after impregnating.

Features and benefits:

- Selectra Control® microprocessor control with 5 to 9 customized programs for any type of drying
- Compass Control® microprocessor control (for CD 130/190)
- with drum reversing mode (right-hand, left-hand rotation)
 - drum made of stainless steel
- large self-cleaning lint sieve for easy maintenance

Special Designs:

- Residual moisture control RMC
- Additional equipment for drying of masks (CD 290 / CD 530)

**CombiDry**

CombiDry 130, 1x jacket, 7 kg cloth	7904009	1	487
CombiDry 190, 2x jackets, 16 kg cloth	7904014	1	487
CombiDry 290, 20x masks, 3x jacket, 16 kg cloth	7904015	1	487
Application for CombiDryer 290	6901960	1	487
CombiDry 350, 4x jacket, 19 kg cloth	7904035	1	487
CombiDry 550, 35x masks, 6x jacket, 29 kg cloth	7904050	1	487
Application for CombiDryer 550	6901961	1	487
CombiDry 650, 8x jacket, 36 kg cloth	7904075	1	487

**CombiPac - ready to use system**

CombiPac I - comprising CombiClean 130, CombiDry 290, dosing pump	7904010	1	487
CombiPac II - comprising CombiClean 250, CombiDry 550, dosing pump	7904020	1	487
CombiPac III - comprising CombiClean 135, CombiDry 290, dosing pump	6570175	1	487
CombiPac IV - comprising CombiClean 245, CombiDry 550, dosing pump	6570176	1	487

ENGINEERED SOLUTIONS

PRODUCT	PART NO	PACKAGING UNIT	CATEGORY
---------	---------	----------------	----------

FURNISHING PROGRAMS FOR WORKSHOPS

Equipment for the safe transport of compressed air cylinders, respiratory and personal protective equipment.
Cylinder and transport trolleys available in various variants.

Features and benefits:

- Made of Stainless Steel
- Corners protective by impact protection covers made of plastic
- 4 steering rollers for improved manoeuvring in Confined space,
2 steering rollers with brakes
- Special designs available

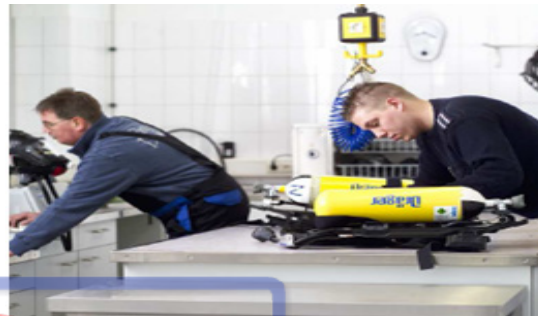

Cylinder Trolley - powder coated

Cylinder Trolley for 15x 6L composite cylinders
2 welded grates
4 Swivel castors (2 are lockable)
1 chipboard, 19 mm, melamine

TBA

1

487

Cylinder Trolley for 24x 4L composite cylinders

TBA

1

487

Cylinder Trolley for 24x 4L composite cylinders

TBA

1

487

Cylinder Trolley - Stainless Steel

Cylinder Trolley FW-1
for 12x 6.8L/300 bar cylinders, aperture width 160mm

Place You Put Your Faith



6570163

1

487

Cylinder Trolley FW-2

6570164

1

487

Cylinder Trolley FW-3

6570165

1

487

Cylinder Trolley FW-4

6570166

1

487

Cylinder Trolley FW-5

6570167

1

487

Cylinder Trolley FW-6

6570168

1

487

Cylinder Trolley FW-7
for 9 lying cylinders diameter 100mm and 4 standing cylinders diameter 200mm



TBA

1

487

Transport Trolley - powder coated

1x cover plate

2 Inclined boards with an upstand at the back

4 swivel castors (2 are lockable)



TBA



1

487

ENGINEERED SOLUTIONS

PRODUCT		PART NO	PACKAGING UNIT	CATEGORY
Transport trolley for chemical protection suits 1 plastic tub, capacity 200 l 4 swivel castors (2 are lockable)		TBA	1	487
Transport trolley Stainless Steel TW1, 3 even trays		6570170	1	487
Transport trolley Stainless Steel TW2, 1 board, 2 sloped trays		6570171	1	487
Transport trolley Stainless Steel TW5 to accommodate 12 baskets, with drip tub		TBA	1	487
Transport trolley Stainless Steel TW6, 1 descending horizontal bars, with drip tub		TBA	1	487
Transport trolley Stainless Steel TW7, 1 board		TBA	1	487
Transport trolley Stainless Steel TW8, 1 even tray		TBA	1	487
Plastic support for cylinder trolley - 5 strips for 6.8L composite cylinders		TBA	1	487
Drip unit for 20 masks 2 wall brackets 5 different S-hooks per bar		TBA	1	487
Drip rack for 2 CPS baseplate with 4 boreholes for fixing 2 pairs of parallel elbow pipes for CPS shoes		TBA	1	487
Vice Clamping jaws with a width of 120mm Spindle clamping width 150mm forged parallel jaw vice		TBA	1	487
Clamping device for breathing air cylinders Operating pressure 1-6 bar Zinc-plated 15.5 kg		6573055	1	487
Mechanical clamping device for mechanically holding BA cylinders		TBA		487
Compressed air distributor with 7 swivelling coupling (self-venting) for connecting max. 7 lung demand valves Incl.uding connection hoses and mounting material		6570084		487

ENGINEERED SOLUTIONS

PRODUCT	PART NO	PACKAGING UNIT	CATEGORY
Rack for all compressed air and closed-circuit breathing apparatus to hang the unit for testing	TBA		487
Shower set with double hole-deck mounted faucet 1/2" or 3/4" wall mounted Standpipe made of Stainless Steel, Stainless Steel hose Self shutting shower head with recoil and pull out spray spout		TBA	487
Wall mounted dispenser for cleaning, disinfecting and care of the hands		TBA	487

DOSAGE UNIT

Microprocessor controlled dosage unit for precise production of aqueous disinfectant solutions.
The dosage unit DG 1 is an admixing device for disinfectants. Due to its precise dosage performances and safety-related equipment it is especially suitable for the operation at fire brigades.

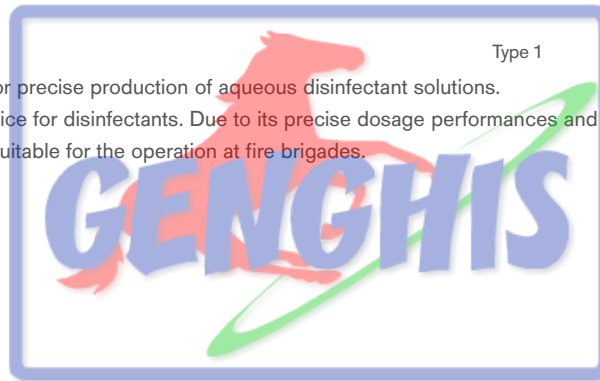

Place You Put Your Faith

Dosage Unit DG1	6570187	1	487
Helios™ Stainless Steel Care Detergent	7904069	1	487
Chromol™ Stainless Steel Care Product	7904070	1	487

Type 2

ENGINEERED SOLUTIONS

PRODUCT	PART NO	PACKAGING UNIT	CATEGORY
---------	---------	----------------	----------

TRAINING GALLERY SYSTEMS

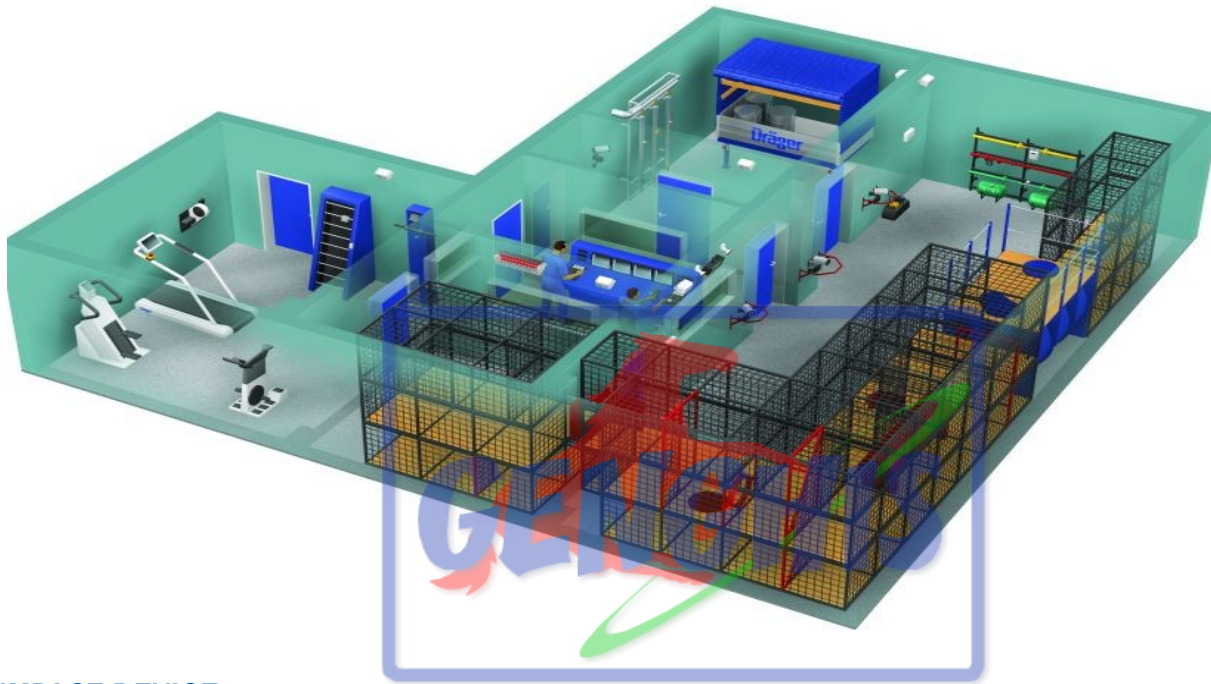

IMPACT DEVICE

During training, a weight will be raised and lowered over a rope pulley. Work done per stroke: 22 kg, with strong aluminium pulley mounted on ball bearings and 6 mm thick galvanized steel rope. The length of the pulley is 1 meter. A special guide stops the rope from coming off the pulley if it is not pulled straight. The neatly shaped plastic grip bar with two guard rings is 1.85 m above the floor and can thus also be reached by persons of smaller stature. A green light indicates the start and end of the exercise. A white light indicates whether the exercise has been carried out properly and evaluated. Contact-free scanning of the weight in both end positions ensures that only full strokes are counted. Impacts at the end positions are damped by flexible rubber elements.

Features and benefits:

- Permanent display of the number of predetermined strokes
- Continuously counting of performed strokes on a large digital display.
- Automatic shutdown with acoustic signal after reaching the desired stroke



Impact device

6573033

1

488

ENGINEERED SOLUTIONS

VERSION	SAFETY VALVE 225 BAR	PRESSURE SENSOR	B-CONTROL PANEL	SWITCH-OVER VALVE	PRESSURE REDUCER	SUITABLE FOR DSF	PART NO
---------	-------------------------	--------------------	--------------------	----------------------	---------------------	---------------------	---------

TREAD MILL "OEM VALIANT"

This treadmill lends itself especially for use in rooms due to the low height of the running surface. The unit comprises an emergency stop-function. Heavy duty design and specially programmed such as pulse-automatic, (individual programs can be defined).

Features and benefits:

- Low maintenance
- Low operating cost thanks to low energy consumption
- Sockless belt
- User defined programs
- Low space requirements
- Multifunctional touch screen operation
- Speed 0.5 to 20 km/h
- Continuously adjustable Incl.ine 0-25%



OEM Valiant	TBA	1	488
-------------	-----	---	-----

ENDLESS LADDER

The ladder is one of the best proven training aids. It has already been used in training facilities for miners and fire brigades since the beginning of the century. The vertical tread mill follows this concept. In renowned Dräger quality, this central component facilitates training in most realistic manner. Thanks to its automatic start-stop and a gentle drive, the trainee always remains at the right position. Its velocity is infinitely adjustable within the range of 3 to 25 m/min. Compared to a "normal" ladder, it is of extremely compact design so that it can be installed at almost any place. Without readjustment of the counter mechanism or the rise velocity it enables several trainees in succession to perform their exercise under absolutely identical conditions.

Features and benefits:

- Virtually wear-resistant and extremely soft self-braking motor
- Sturdy construction
- Electronic measurement of climbed height
- Automatic switch off
- Adjustable velocity



Endless ladder	6573032	1	488
----------------	---------	---	-----

ENGINEERED SOLUTIONS

VERSION	SAFETY VALVE 225 BAR	PRESSURE SENSOR	B-CONTROL PANEL	SWITCH-OVER VALVE	PRESSURE REDUCER	SUITABLE FOR DSF	PART NO
---------	-------------------------	--------------------	--------------------	----------------------	---------------------	---------------------	---------

ARM ERGOMETER F33

The F33 is usable as an arm ergometer while standing or sitting. Thanks to the compact design it is really versatile. The application area can be that of normal ergometer or special tasks, for which conventional ergometer cannot be used. As standard accessory a workload programmer is Included in the delivery. This offers the possibility to program the ergometer programs and to monitor some of the parameters on the LCD. Interfaces provide the communication with other external devices.

Features and benefits:

- Manual crank set instead of pedals
- Pedal alarm adjustment
- Speed display
- Wall mounting
- Sport pedals



F33				6573034	1	488
-----	--	--	--	---------	---	-----

BICYCLE DYNAVIT CON 33

The Dräger Dynavit Con 33 provides an ideal cardiovascular training. The programme storage contains 4 pre-installed training programmes and an automatic programme with pulse rate controlled power modulation. The modulation runs completely autonomously and based upon the predetermined training goal pulse. The Dräger Dynavit Con 33 features as standard an automatic torque switch-off which reduces the resistance in case of overload. This prohibits injuries and overloading of the active and passive musculoskeletal systems.

Features and benefits:

- Low maintenance
- Low operating cost thanks to low energy consumption
- Individual training programs
- Minimal space requirements
- Display parameters

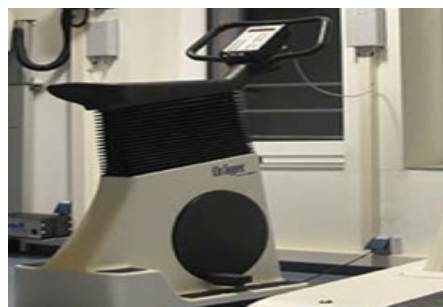

Con 33				6573077	1	488
--------	--	--	--	---------	---	-----

ENGINEERED SOLUTIONS

VERSION	SAFETY VALVE 225 BAR	PRESSURE SENSOR	B-CONTROL PANEL	SWITCH-OVER VALVE	PRESSURE REDUCER	SUITABLE FOR DSF	PART NO
---------	-------------------------	--------------------	--------------------	----------------------	---------------------	---------------------	---------

HAND-HELD FIRE EXTINGUISHER TRAINER (TUTOR)

Safe fire simulation tray made of Stainless Steel with water bath. The system is supplied with electric power from a gel battery and can be controlled from a safe distance using a hand-held remote switch or control. The unit's technical installation are secured in a separate compartment. Two wheels and strong handles guarantee mobility.



Fire Extinguisher Training Tub with automatic extinguishing success monitoring (German Version)	6576148	1	488
PROPS (German Version)			
Firewood pile of stainless steel, 80x50x20 cm	6576149	1	488
Shelf of stainless steel, 90x90x20 cm	6576150	1	488
Electric motor of stainless steel, 75x30x35 cm	6576151	1	488
Electric control cabinet of stainless steel, 60x50x20 cm	6576152	1	488
Waste paper basket of stainless steel, 60x40x35 cm	6576153	1	488
Passive dummies			
Monitor made of Stainless Steel, 50x30x40 cm	6576154	1	488
Cooker fire (grease explosion in pan) made of Stainless Steel, 40x40x20 cm	6576155	1	488

The above prices are based on air freight. Due to the excessive weight, air freight cost is significant. Sea freight can also be used which decreases the cost but extends the lead-time by 6 weeks.

ENGINEERED SOLUTIONS

PRODUCT	PART NO	PACKAGING UNIT	CATEGORY
---------	---------	----------------	----------

FOGSTAR

the Fogstar is a high output fog generator which is primary used in stationary respiratory protection facilities. The 2500 watts fog machine enables the fast production of large amounts of fog. Using non-polluting fog fluid (DW special), it is possible to reach an output of up to 2600 cbm/min. Within a range of 10 m contrast-weak objects are not to be recognized, black-and-white contrasts are to min. 50% masked. The same fog amount produces e.g. in a room with 500 m³ volume within 1 min. a visibility range of max. 2 m with 100% masking of high-contrast objects.

- Internal tank 5L, connection capability for any external tank i.e.25L
- Remote control port (6-pole XLR) available, control from panel possible



Fogstar	6573042	1	488
Fog liquid DW special 25 L (only for Fogstar)	6573043	1	488

Place You Put Your Faith

ENGINEERED SOLUTIONS

PRODUCT	PART NO	PACKAGING UNIT	CATEGORY
---------	---------	----------------	----------

FIRE FOG 3000

The Fire Fog 3000 is a high output fog generator which is primarily used in stationary respiratory protection facilities. The fog machine is made of robust material and provides a uniform distribution of the fog in the room via the 1800 W heating element. Using non-polluting fog fluid (ATÜ special), it is possible to reach an output of up to 1200 cbm/min. This results in a vision of 0.3-0.5 meter for a fog pressure of over 20 meters. Optionally, the control via a radio remote control with timer function is possible, which also offers ip64 protection.

- Internal tank 5L
- Robust housing 1.5mm Galvanised Steel
- 2500 W heating element for 1200 m³/min fog volume
- Fog fluid ATU Special must be used



Fire Fog 3000	6573040	1	488
ATU Special 25 L	6573041	1	488

HOT FOG 1700

The hot fog 1700 is a high output smoke generator which is primarily used in fire training galleries. It generates smoke which is not a danger to the health of the participants, which is temperature resistant over 200 degrees and can also be applied in hot smoke trainings and simulations. The 1700 W heating element offers a uniform distribution of the smoke in the room. The Hot Fog 1700 does not need a compressed air cylinder and still reaches a high smoke power of approx. 700 m³/min. A radio remote control with timer and interval function that can be controlled via DMX is Included in the scope of delivery and offers a user-friendly control of the smoke generator.



- Can be used in high temperatures
- Low operational cost
- Smoke fluid Hot Fog must be used
- 1700 W heating element for 700 m³/min fog volume
- Additional compressed air is not required

Hot Fog 1700	6573044	1	488
Hot Fog 20 L	6573045	1	488

ENGINEERED SOLUTIONS

PRODUCT	PART NO	PACKAGING UNIT	CATEGORY
---------	---------	----------------	----------

TRUCK RESCUE TRAINER TRT-7000

- Various replaceable parts for cutting and destroying
- Different type of leaks and tanks
- Smoke generation
- Transportable
- Configurable
- Different training scenarios



Truck Rescue Trainer TRT-7000

TBA

1

238

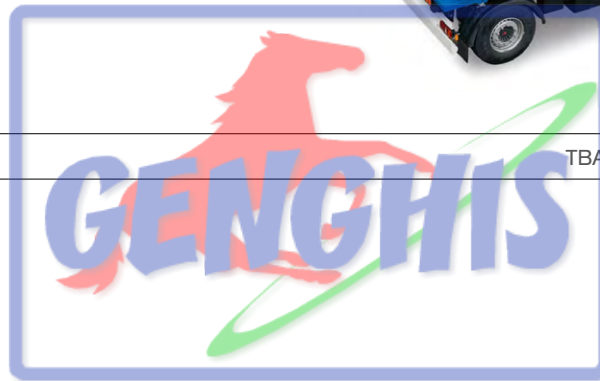

Place You Put Your Faith

ENGINEERED SOLUTIONS

PRODUCT	PART NO	PACKAGING UNIT	CATEGORY
---------	---------	----------------	----------

FIRE TRAINING SYSTEMS

AIRCRAFT FIRE SIMULATOR AFS-3000

- 4 Different fire scenarios
- Propane gas fired
- Easy to use, radio controlled
- Transportable
- Upgradeable (module for internal fires)
- No need for civil works
- Short delivery time
- Low-budget solution



AFS 3000

TBA

1

238

20' FIRE TRAINING CONTAINER (GAS FIRED)

- 1 Fire compartment, 2 fire scenarios (one standard fire point plus flashover fire)
- LPG fired
- Easy operation
- Configurable with accessories and add-ons
- Safe training for low budget
- Short setup times
- No civil works required
- Fire resistant door
- Ventilation Fan
- Temperature control
- Gas detector
- Handheld controller



20' Fire Training Container (gas fired)

TBA

1

238

ENGINEERED SOLUTIONS

PRODUCT	PART NO	PACKAGING UNIT	CATEGORY
---------	---------	----------------	----------

20' FIRE TRAINING CONTAINER (GAS FIRED)

- 1 Fire compartment, 2 fire scenarios
- Control room with window to the training compartment
- LPG fired
- Easy operation
- Configurable with accessories and add-ons
- Safe training for low budget
- Configuration according to budget possible
- Short setup times
- No civil works required



20' Fire Training Container (gas fired)	TBA	1	238
---	-----	---	-----

40' FIRE TRAINING CONTAINER (GAS FIRED)

- Two Fire compartments, 4 fire scenarios
- Control room with window to the training compartment
- LPG fired
- Easy operation
- Configurable with accessories and add-ons
- Safe training for low budget
- Configuration according to budget possible
- Short setup times
- No civil works required
- Fire resistant door
- Ventilation Fan
- Temperature control
- Gas detector

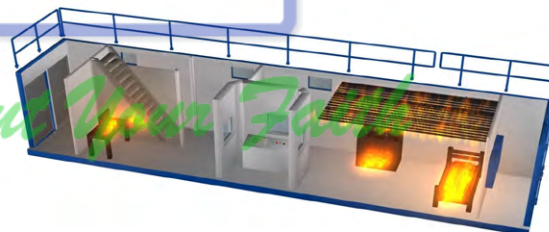

20' Fire Training Container (gas fired)	TBA	1	238
---	-----	---	-----

ENGINEERED SOLUTIONS

PRODUCT	PART NO	PACKAGING UNIT	CATEGORY
---------	---------	----------------	----------

SIMSA REFUGE CHAMBERS

Scope of supply for Standard Setup

- Battery backup for 36 hours
- Electrical Input Connection: 230V 50/60 HZ
- Internal Gas Monitoring System Including 3x PAC units for CO₂, CO and O₂
- External status lights and siren
- Oxygen regulator flow meters
- Stretcher, chemical toilet, fire extinguisher and first aid kit
- Sodaslime (free pour, 18 Kg containers) or Draegersorb Cartridges
- CO₂ Scrubber
- Brackets for air and oxygen cylinders
- Airlock area Including secondary door (only in 8 to 30 person chambers)



RCM 04/36	4-Person Refuge Chamber	6908630	1	534
RCM 06/36	6-Person Refuge Chamber	6908631	1	534
RCM 08/36	8-Person Refuge Chamber	6908632	1	534
RCM 10/36	10-Person Refuge Chamber	6908633	1	534
RCM 12/36	12-Person Refuge Chamber	6908634	1	534
RCM 16/36	16-Person Refuge Chamber	6908635	1	534
RCM 20/36	20-Person Refuge Chamber	6908636	1	534
RCM 26/36	26-Person Refuge Chamber	TBA	1	534

Options

Step-Down Transformer (Voltage must be specified)	1
Insulation	1
Internal Gas Monitoring System - Portable X-AM 7000	1
Internal Gas Monitoring System - Fixed Polytron 5720 CO ₂ IR	1
Internal Gas Monitoring System - Fixed Polytron 5000 CO	1
Internal Gas Monitoring System - Fixed Polytron 5000 O ₂	1
External Gas Monitoring System - Fixed Polytron 8000 CO	1
External Gas Monitoring System - Fixed Polytron 8000 O ₂	1
Additional Status light (Price per light)	1
Digital IfU to be shown on a basic screen	1
Digital IfU to be shown on a touch screen industrial PLC	1
Transportation Wheels for refuge chamber	1

Dräger Region South East Europe | Rev: 0 | Subject to modification! | www.draeger.com

ENGINEERED SOLUTIONS

PRODUCT	PART NO	PACKAGING UNIT	CATEGORY
Automation for refuge chamber Including: - Temperature Monitoring (Internal/ External) - Differential Pressure Switch - Battery Voltage Level - Mine Air Pressure Switch - Status Light Monitoring - Mine Air CO Monitoring - Motion Sensor - Door Switch for Battery Cabinet - Door Switch for main door - Interactive Touch Screen Panel Computer - Data Transmission (Ethernet is Included)		1	
CCTV		1	
Other colour options			
Dräger BPU		1	
Positive Pressure - Please refer to 'Positive Pressure Unit' section			
Consumables			
DrägerSorb® 400 ind	Dräger soda lime absorbent for acidic gases, e.g. carbon dioxide (CO ₂) Supplied in 18Kg Tubs	6739010	1
DrägerCat® K	DrägerCat® is a catalyst which converts highly toxic carbon monoxide into carbon dioxide in the presence of atmospheric oxygen Supplied in 4Kg Tubs.	6738665	1
Desiccant (Drying agent)	9 kg Tub	3502784	1
ESTIMATED QUANTITY OF CONSUMABLES REQUIRED PER REFUGE CHAMBER for 36 HOURS*			
Chamber Size	Drägersorb® (18 kg)	DrägerCat®	Drying agent
4-Person	2	2	12
6-Person	3	2	12
8-Person	4	2	12
10-Person	6	2	12
12-Person	6	2	12
16-Person	8	2	12
20-Person	10	2	12

* Please refer to manufacturer's specifications regarding exact quantities of catalysts & absorbents required.

LEAKAGE RATES AND POSITIVE PRESSURE TESTING

The ingress of toxic gases or other contaminants into refuge chambers during an underground emergency is a serious safety issue, especially when the external air supply has been compromised and the refuge is operating without positive pressure (i.e. in stand-alone mode). Positive pressure is an important safety characteristic that prevents the ingress of contaminants into refuge chambers. It is a requirement of the 2013 WA Refuge Chamber Guidelines (page 7). Positive pressure testing involves using positive pressure to quantify the leakage rate of a refuge.

Refuge chamber leak test	Leakage test of one refuge chamber with certificate	1980014	on request
--------------------------	---	---------	------------

Travel cost is excluded

Dräger Region South East Europe | Rev: 0 | Subject to modification! | www.draeger.com

Place You Put Your Faith

PORTABLE
GAS DETECTION

PERSONAL
PROTECTION
EQUIPMENT

DRUG & ALCOHOL
DETECTION

MASKS & FILTERS

FIRE & GAS
DETECTION
SYSTEMS

ENGINEERED
SOLUTIONS

SERVICE,
TRAINING & RENTAL

DIVING
TECHNOLOGY

ENGINEERED SOLUTIONS

PRODUCT	PART NO	PACKAGING UNIT	CATEGORY
---------	---------	----------------	----------

BPU

Automatic Breathing Air Supply Unit.

As a compact solution for installation in positive pressure protected escape chambers or shelters, the Dräger BPU can be easily integrated into your rescue concept. The automatic breathing air supply unit with integrated CO₂ absorber and uninterruptible power supply provides up to 96 hours of breathable air.

The Dräger BPU provides several people with a safe haven for up to 96 hours, without the need for personal respiratory protective equipment. This is achieved by the generated positive pressure and the regeneration of exhaled air with the help of Dräger's proven soda lime. Carbon dioxide is removed by absorption and oxygen is added manually. The positive pressure is created with breathing air.

GENGH



Draeger BPU (Including batteries for 36 hours)	6905428	1	534
---	---------	---	-----

Place You Put Your Faith

TRAINING



TRAINING

Detection - Alcohol / Portables / Fixed Gas	436
Protection - Chemical / Respiratory	436
Other	437

Place You Put Your Faith

TRAINING

TRAINING 2018	COURSE CODE	MAX CLASS SIZE	DURATION
---------------	-------------	----------------	----------

DETECTION

ALCOHOL			
BREATH ALCOHOL DETECTOR - ALCOTEST (ALL) MAINTENANCE	1993835	8	12 hours
BREATH ALCOHOL DETECTOR - ALCOTEST (ALL) USER TRAINING	1993834	12	2 hours
DRUGTEST 5000 - USER TRAINING	1993905	12	2 hours
PORTABLES AND FIXED GAS			
AEROTEST - USER TRAINING	1993831	12	2 hours
X-DOCK / E-CAL STATIONS - USER TRAINING	1993829	12	2 hours
PORTABLE AND FIXED GAS - MAINTENANCE	1993833	8	8 hours
PORTABLE AND FIXED GAS - USER TRAINING	1993828	12	4 hours
TUBES & CMS - USER TRAINING	1993832	12	2 hours
X-ZONE 5000 USER TRAINING	1993957	12	2 hours

PROTECTION

CHEMICAL			
CHEMICAL PROTECTION SUIT - USER TRAINING	1993836	8	4 hours
RESPIRATORY			
BREATHING AIR COMPRESSOR - USER TRAINING	1993824	12	2 hours
CANISTER MASKS - USER TRAINING	1993822	12	2 hours
CLOSED CIRCUIT - MAINTENANCE	1993845	8	16 hours
CLOSED CIRCUIT - USER TRAINING	1993844	12	8 hours
OXYGEN SELF RESCUERS - USER TRAINING	1993852	12	2 hours
MASK FIT TESTING	1993896	12	4 hours
OPEN CIRCUIT BREATHING APPARATUS - INTRODUCTION	1993821	12	2 hours
OPEN CIRCUIT BREATHING APPARATUS - MAINTENANCE	1993826	8	16 hours
OPEN CIRCUIT BREATHING APPARATUS - USER TRAINING	1993823	12	4 hours
OPEN CIRCUIT ESCAPE SETS - USER TRAINING	1993851	12	2 hours
QUICKFILL & FREEK MONTHLY INSPECTIONS	1993902	8	4 hours

TRAINING

TRAINING 2018	COURSE CODE	MAX CLASS SIZE	DURATION
---------------	-------------	----------------	----------

OTHER

HARD COPY CERTIFICATES	1993865	-	-
INSTRUCTOR TRAINING	1993868	8	8 hours
TRAINING MODULE	1993867	-	-
ACCOMMODATION PER DAY			
TRAVEL PER HOUR			



Place You Put Your Faith

DIVING TECHNOLOGY



DIVING TECHNOLOGY

Dräger PSS® DIVE EN	439
Dräger Secor 7000	440
Full Face Mask Panorama Nova Dive	441
Divesorb	442

Place You Put Your Faith

DIVING TECHNOLOGY

PRODUCT	DESCRIPTION	PART NO	PACKAGING UNIT	CATEGORY
---------	-------------	---------	----------------	----------

DRÄGER PSS® DIVE EN



The professional diving apparatus PSS Dive EN is a modular concept, that permits customized configurations. The diving set is an assembly of single components and the total price is the sum of the price of the selected single components. The prices are valid per component and includes the assembly. Please choose your preferred components:

Basic Set				
Dräger PSS® DIVE EN (carrying system)	Carrying system padded carrying system for back mounting with shoulder, waist, crotch and chest strap, drop system for weights and D-rings, retaining strap.	T54210	1	565
Basic unit size M		T54136	1	565
Basic unit size L		T54137	1	565
Basic unit size XL		T54309	1	565
Cylinder retaining strap		T54130	1	565
Cylinder straps				
Cylinder straps for single cylinder 6 L, 7 L ,10 L or 12 L		T54038	1	565
Cylinder straps for twin cylinder 6 L, 7 L ,10 L Incl.uding spacer and elastic		T54039	1	565
Cylinder straps for twin cylinder 12 L Incl. uding spacer and elastic		T54275	1	565
Spacer for duo-cylinder		T54116	1	565
Elastic		T14094	1	493
Loop		T50989	1	596
Transport case				
Transport case for PSS Dive EN		T16847	1	565
Buoyancy system				
Buoyancy control bladder 25 L in wing style, lift 210 N		T54036	1	565
Inflator hose 0.78 m for PSS Dive (EN)		T54042	1	565

DIVING TECHNOLOGY

PRODUCT	DESCRIPTION	PART NO	PACKAGING UNIT	CATEGORY
---------	-------------	---------	----------------	----------

DRÄGER SECOR 7000



The diving regulator Dräger Secor 7000 was developed for the professional diver. The medium pressure hose can be attached to either side of the 2nd stage to ensure diver comfort. The Secor 7000 integrates perfectly with the Panorama Nova Dive full-face mask. The complete pneumatics can be individually configured by the diver.

- 300 Bar Technology First stage –membrane-controlled –supply pressure compensated –no decline in airflow
- Individual configuration –three high pressure ports and ie medium pressure ports to connect all our need –igh leibilit in coniguring the pneumatics
- Second stage –downstream, balanced, and with integrated pressure relief ale – hose connection on both sides – Fits perfectly with the Dräger anorama oa Die

Basic Set				
Dräger Secor 7000 1st Stage		T54400	1	565
Dräger Secor 7000 2nd Stage		T54400	1	565
Pressure Gauge 0 – 400 bar,31.50 inch / 0.80 m		T53704	1	565
Pressure Gauge 0 – 400 bar,47.24 inch / 1.20 m		T53625	1	565
Dual Console With Pressure Gauge		T53703	1	565
Console With 3 Components (Complete)		T54301	1	565
Low Pressure Warning		T53615	1	565
Inflator Hose 47.24 inch / 1,2 m		T54042	1	565
Inflator Hose 30.7 inch / 0,78 m		T54188	1	565
Panorama Nova Dive		T53510	1	565
Panorama Nova Dive Sport		T53700	1	565



ST-2/071-2004



D-10386-2016



ST-2/04-2004



ST-2/0716-2004

DIVING TECHNOLOGY

PRODUCT	DESCRIPTION	PART NO	PACKAGING UNIT	CATEGORY
---------	-------------	---------	----------------	----------

FULL FACE MASK PANORAMA NOVA DIVE



The mask has three Dräger plug-in connections. The central port is designed for connecting the main breathing system. The two side connections may be used for an emergency second stage regulator and a microphone for the communication system. The Panorama Nova Dive features an additional exhalation valve which makes it very easy for the diver to purge water. At the surface the diver can breathe ambient air providing he has not inserted the main breathing system into the mask. This conserves the cylinder air supply until actually needed. As it is positioned close to the face, the new flat visor offers a wide field of vision. This also reduces the volume of air inside the mask, thereby reducing buoyancy. There are two integrated nose pieces in the visor to permit pressure equalisation.

The mechanical residual pressure alarm The professional diving apparatus PSS Dive EN is a modular concept, that permits customized configurations. May be inserted into the side of the visor as an option. The Panorama Nova Dive also comes with a protective visor for welding; this folds down. After a dive the mask can be removed by means of the unique quick release system. The Panorama Nova Dive has also been developed for use with rebreathers. For this application the inner mask is replaced by an integrated bite mouthpiece. No connector is provided in rebreather masks for the residual pressure alarm.

For open diving systems				
Panorama Nova Dive Sport		T53700	1	565
Panorama Nova Dive		T53510	1	565
For re-breather diving systems				
Panorama Nova Dive R	magnetic, with mouthpiece for LAR, FGT 5400 please order T- piece additionally	T52730	1	565
Panorama Nova Dive	Mask non-magnetic, mouth piece for LAR/FGT 5400 please order T-piece additionally NATO stock no. 4220-12-363-3235	T16000	1	562
Accessories				
T-Piece with valve	to adapt breathing hoses from LAR diving apparatus	T16010	1	562
T-Piece with valve	to adapt breathing hoses from FGT 5400 diving apparatus	T16330	1	562
Residual pressure warning	complete with pressure switch, connecting hose and warning unit for	T53615	1	565
blank plug for residual pressure warning		T53682	1	596
Spare parts				
Welding visor	for Panorama Nova Dive SW	T54020	1	596
maskbox II	for transport and storage with carrying strap	R54610	1	421

DIVING TECHNOLOGY

PRODUCT	DESCRIPTION	PART NO	PACKAGING UNIT	CATEGORY
---------	-------------	---------	----------------	----------

DIVESORB®



The soda lime of the DiveSorb® - Family shall be used for the absorption of acid gases, e.g. carbon dioxide, in the field of recreational diving, professional diving, deep diving systems, decompression chambers and submarines.

DiveSorb® Pro				
DiveSorb® Pro (4.5 kg)	packed in plastic canister made from PE-HD NATO stock no: 4240-12-348-4361	6737062	1	454
DiveSorb® Pro (37 lbs/16.8 kg)	packed in plastic canister made from PE-HD	6737818	1	454
DiveSorb® Pro (18 kg)	packed in plastic canister made from PE-HD NATO stock no: 4240-12-376-0682	6737109	1	454
DiveSorb® S				
DiveSorb® S (18 kg)	recommended for the use in CO ₂ -absorption systems of submarines. packed in plastic canister made from PE-HD NATO stock no: 4240-12-362- 1841	6737111	1	454
<i>Place You Put Your Faith</i>				
One way-cartridge				
	packed in plastic canister made from PE-HD NATO stock no: 4240-12-362-1841 CO ₂ - Absorber for the Dräger submarine CO ₂ - absorption system NATO stock no: 4240-12-162- 7578	CH16720	1	531

Not all products, features, or services are for sale in all countries.
Mentioned Trademarks are only registered in certain countries and not necessarily in the country in which this material is released. Go to www.draeger.com/trademarks to find the current status.

CORPORATE HEADQUARTERS

Drägerwerk AG & Co. KGaA
Moislinger Allee 53-55
23558 Lübeck, Germany

www.draeger.com



Place You Put Your Faith

Manufacturer:
Drägerwerk AG & Co. KGaA
Moislinger Allee 53-55
23542 Lübeck, Germany

REGION EUROPE SOUTH
Dräger Safety France SAS
25, rue Georges Besse
92182 Antony Cedex
Tel +33 1 46 11 56 00
Fax +33 1 40 96 97 20
europe.south@draeger.com

Locate your Regional Sales
Representative at:
www.draeger.com/contact



Place You Put Your Faith